

jaga
CLIMATE DESIGNERS



MINI VRIJSTAAND



MINI VRIJSTAAND

| | | | |
|---|-----------|--------------------------|-----------|
| INHOUDSOPGAVE | 3 | Onderdelen | 12 |
| TECHNISCHE INFORMATIE | 5 | Correctiefactoren | 13 |
| Afmetingen | 5 | Drukverliezen | 14 |
| Standaard levering | 5 | Type 05 | 14 |
| Kleuren | 5 | Type 06 | 15 |
| Hoogte 008 waterzijdige aansluiting | 6 | Type 09 dubbelzijdig | 16 |
| Standaard aanvoer links of rechts | 6 | Type 10 | 17 |
| Hoogte 013 - 023 -028 waterzijdige aansluiting | 6 | Type 11 | 18 |
| Standaard: bediening beneden | 6 | Type 14 dubbelzijdig | 19 |
| Afstandsbediend | 6 | Type 15 | 20 |
| Meest gebruikte aansluitsets | 7 | Type 16 | 21 |
| Hoogte 008 | 7 | Type 19 dubbelzijdig | 22 |
| Hoogte 013- 023 - 028 | 7 | Type 20 | 23 |
| Technische tabel vaste voeten | 8 | Type 21 | 24 |
| Hoogte 008 | 8 | | |
| Hoogte 013 | 8 | | |
| Hoogte 023 | 9 | | |
| Hoogte 028 | 9 | | |
| Technische tabel verstelbare voeten | 10 | | |
| Hoogte 008 | 10 | | |
| Hoogte 013 | 10 | | |
| Hoogte 023 | 11 | | |
| Hoogte 028 | 11 | | |



MINI VRIJSTAAND

AFMETINGEN (in cm)

HOOGTE 008

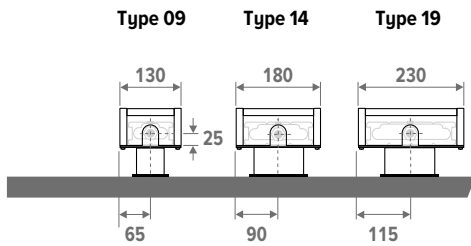

HOOGTE 013

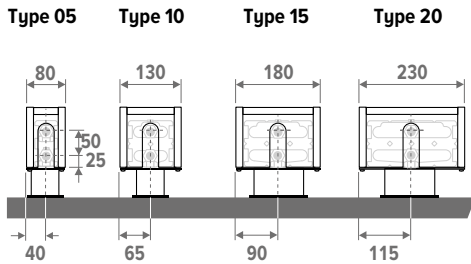

HOOGTE 023/028

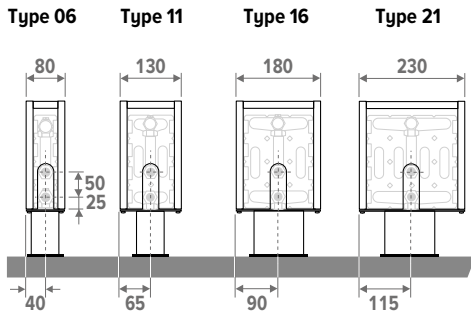

VASTE VOETEN

voor plaatsing op afgewerkte vloeren

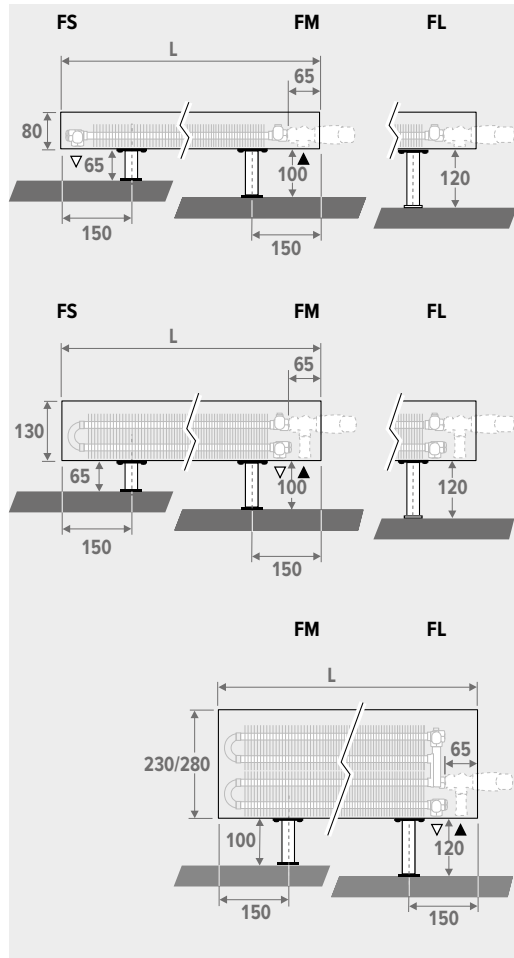

VERSTELBARE VOETEN

voor plaatsing op ruwe ondervloeren

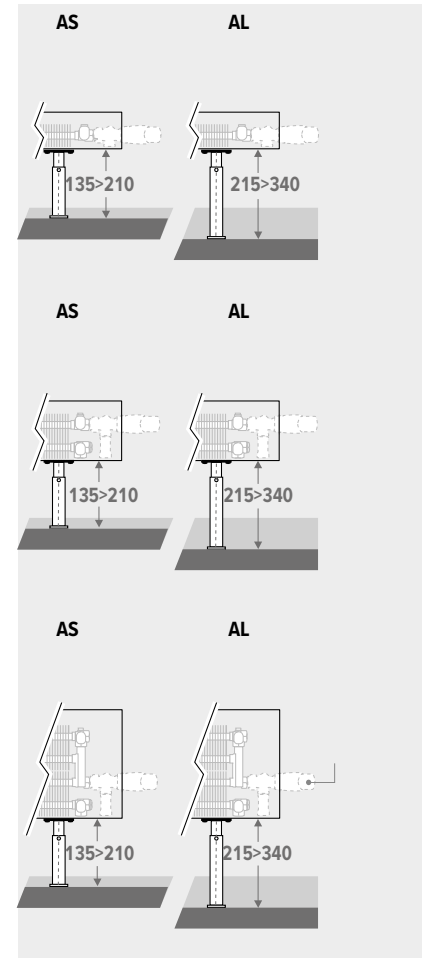

STANDAARD LEVERING

- Low-H₂O warmtewisselaar, ontluchter 1/8" en aftapstop 1/2"
- bekleding uit één stuk voor aansluiting links of rechts
- voeten in dezelfde kleur als de radiator

KLEUREN

Standaard kleuren

- verkeerswit RAL 9016 (133), soft touch licht gestructureerde satijn lak
- zandstraalgrijs (001), fine texture metallic lak
- off-black (145), soft touch licht gestructureerde satijn lak

Andere kleuren

zie Jaga kleurenkaart.

Meerprijs afhankelijk van de lengte van het toestel:

- Lengte < 100 cm
- Lengte van 100 cm tot 200 cm
- Lengte > 200 cm

BESTELCODE VASTE VOETEN

MINF 008 060 09 XXX XX

- Voet: - FS: hoogte 65 mm (enkel voor Mini H008 en H013)
- FM: hoogte 100 mm
- FL: hoogte 120 mm

Kleur

Type

Lengte

Hoogte

BESTELCODE VERSTELBARE VOETEN

MINF 008 060 09 XXX XX

- Voet: - AS: hoogte 135 mm tot 210 mm
- AL: hoogte 215 mm tot 340 mm

Kleur

Type

Lengte

Hoogte

MINI VRIJSTAAND HOOGTE 008

WATERZIJDIGE AANSLUITING

STANDAARD: DUBBELZIJDIGE AANSLUITING, AANVOER LINKS OF RECHTS

Links of rechts beneden, naar de wand of naar de vloer. Wandaansluiting via onderzijde bekleding. Aansluiting naar de wand binnen de bekleding is niet mogelijk vanwege de dichte achterwand. De installateur kan de warmtewisselaar draaien voor een rechtse of linkse aansluiting.

Aansluiting naar de vloer: set 222 of 282

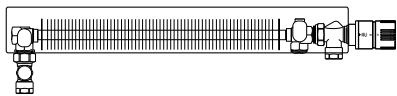

MINI VRIJSTAAND HOOGTE 013 - 023 - 028

WATERZIJDIGE AANSLUITING

STANDAARD: AANSLUITING LINKS OF RECHTS MET BEDIENING BENEDEN

Links of rechts beneden, naar de wand of naar de vloer. Wandaansluiting via onderzijde bekleding. Aansluiting naar de wand binnen de bekleding is niet mogelijk vanwege de dichte achterwand.

Mogelijke Euroconus aansluitsets: 101, 102, 103, 104, 181, 182, 183, 184, 222, 225, 226, 282, 285

Mogelijke M24 aansluitsets: 11, 12, 13, 14

Voorbeeld aansluiting rechts (standaard)

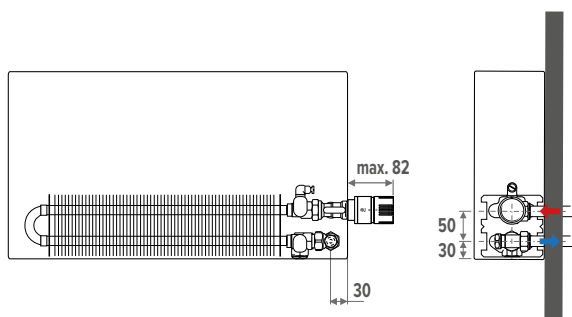

Voorbeeld aansluiting links

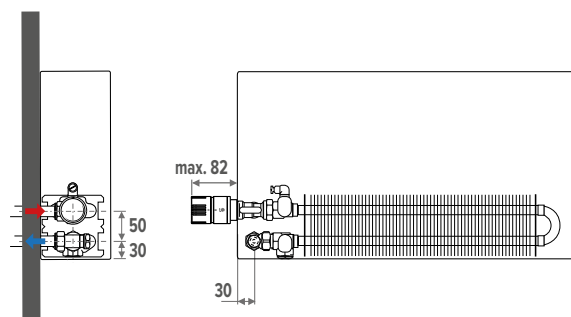

AANSLUITING LINKS OF RECHTS MET BEDIENING OP AFSTAND

De code van de radiator aanvullen met **00** (dichte zijanten). Vb. MINW.013 060 05 xxx **00**

Mogelijke Euroconus aansluitsets: 111, 112, 113, 114

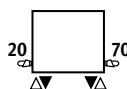

Voorbeeld aansluiting rechts (standaard)

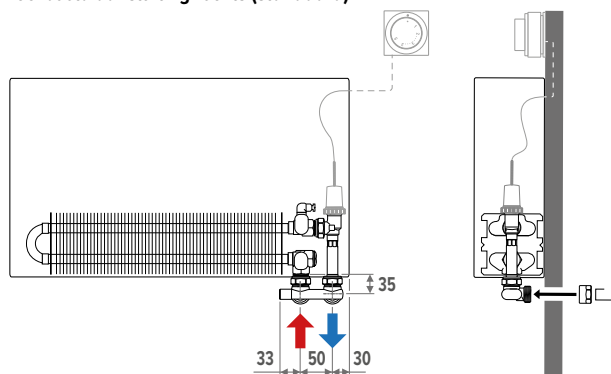

Voorbeeld aansluiting links

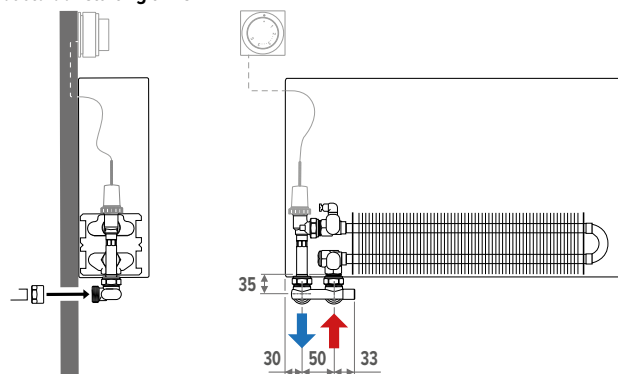

MINI VRIJSTAAND HOOGTE 008

NAAR DE VLOER

Met Jaga ventiel



Met Gampper Vario DP
Dynamisch ventiel



set
222 KVS: 0.8
TWEEPIJP

| | | |
|------------------|----|--|
| COLO JF2 AC 4... | AC | |
| COLO JF2 AW 4... | AW | |
| COLO JF2 AS 4... | AS | |
| COLO JF2 AB 4... | AB | |
| COLO JF2 JH 4... | JH | |

code klemkoppeling invullen

set
282 automatische debietregeling (20 - 340 l/u)
TWEEPIJP

| | | |
|------------------|----|--|
| COLO GF2 AC 4... | AC | |
| COLO GF2 AW 4... | AW | |
| COLO GF2 AS 4... | AS | |
| COLO GF2 AB 4... | AB | |
| COLO GF2 JH 4... | JH | |

code klemkoppeling invullen

MEEST GEBRUIKTE AANSLUITSETS

Klemkoppelingen 3/4" Euroconus

| DUNWANDIG METAAL | | KUNSTSTOF OF VPE/ALU | |
|------------------|--------|----------------------|--------|
| CODE | Buis Ø | CODE | Buis Ø |
| 112 | 12/1 | 612 | 12/2 |
| 114 | 14/1 | 614 | 14/2 |
| 115 | 15/1 | 616 | 16/2 |
| 116 | 16/1 | 618 | 18/2 |
| 118 | 18/1 | 619 | 16/1.5 |
| | | 620 | 20/2 |

*Uitgebreide informatie van de ventielen,
zie brochure "Aansluitsets & ventielen"*

MINI VRIJSTAAND HOOGTE 013- 023 - 028

NAAR DE VLOER - AANVOER BINNENZIJDE

Met Jaga Crossflow ventiel



set
102 KVS: 0.8
TWEEPIJP

| | | |
|-------------------|----|--|
| COLO HBCF AC 4... | AC | |
| COLO HBCF AW 4... | AW | |
| COLO HBCF AS 4... | AS | |
| COLO HBCF AB 4... | AB | |
| COLO HBCF JH 4... | JH | |

code klemkoppeling invullen

Met Gampper Vario DP
Dynamisch ventiel

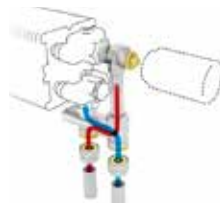

set
182 automatische debietregeling (20 - 340 l/u)
TWEEPIJP

| | | |
|-------------------|----|--|
| COLO GACF AC 4... | AC | |
| COLO GACF AW 4... | AW | |
| COLO GACF AS 4... | AS | |
| COLO GACF AB 4... | AB | |
| COLO GACF JH 4... | JH | |

code klemkoppeling invullen

MEEST GEBRUIKTE AANSLUITSETS

NAAR DE VLOER - AANVOER BUITENZIJDE

Met Jaga H-ventiel

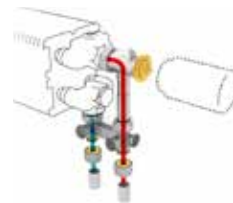

set
104 KVS: 0.8
TWEEPIJP / EENPIJP

| | | |
|-------------------|----|--|
| COLO HBSF AC 4... | AC | |
| COLO HBSF AW 4... | AW | |
| COLO HBSF AS 4... | AS | |
| COLO HBSF AB 4... | AB | |
| COLO HBSF JH 4... | JH | |

code klemkoppeling invullen

Met Gampper Vario DP
Dynamisch ventiel

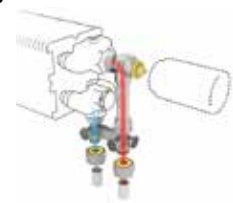

set
184 automatische debietregeling (20 - 340 l/u)
TWEEPIJP

| | | |
|-------------------|----|--|
| COLO GASF AC 4... | AC | |
| COLO GASF AW 4... | AW | |
| COLO GASF AS 4... | AS | |
| COLO GASF AB 4... | AB | |
| COLO GASF JH 4... | JH | |

code klemkoppeling invullen

MINI VRIJSTAAND VASTE VOETEN

TECHNISCHE TABEL

HOOGTE 008

| HOOGTE H | LENGTE L | TYPE T | VERWARMEN Kamertemp. 20°C | | | | | BESTELCODE |
|--------------|-------------|-----------|------------------------------|-------|-------|-------|------------------------|------------------------|
| | | | 35/30 | 45/40 | 50/45 | 55/45 | 75/65 | |
| | | | Watt | Watt | Watt | Watt | Watt | |
| MINF 008 060 | -- | -- | -- | -- | -- | -- | MINF 008 060 06 XXX XX | |
| | 09 | | 35 | 82 | 109 | 123 | 255 | MINF 008 060 09 XXX XX |
| | 14 | | 57 | 134 | 178 | 200 | 416 | MINF 008 060 14 XXX XX |
| | 19 | | 79 | 184 | 245 | 275 | 572 | MINF 008 060 19 XXX XX |
| 070 | -- | -- | -- | -- | -- | -- | MINF 008 070 06 XXX XX | |
| | 09 | | 41 | 96 | 128 | 143 | 298 | MINF 008 070 09 XXX XX |
| | 14 | | 67 | 156 | 208 | 234 | 486 | MINF 008 070 14 XXX XX |
| | 19 | | 92 | 215 | 286 | 321 | 667 | MINF 008 070 19 XXX XX |
| 080 | -- | -- | -- | -- | -- | -- | MINF 008 080 06 XXX XX | |
| | 09 | | 47 | 109 | 146 | 163 | 340 | MINF 008 080 09 XXX XX |
| | 14 | | 77 | 179 | 238 | 267 | 555 | MINF 008 080 14 XXX XX |
| | 19 | | 105 | 245 | 327 | 366 | 762 | MINF 008 080 19 XXX XX |
| 090 | -- | -- | -- | -- | -- | -- | MINF 008 090 06 XXX XX | |
| | 09 | | 53 | 123 | 164 | 184 | 383 | MINF 008 090 09 XXX XX |
| | 14 | | 86 | 201 | 268 | 300 | 625 | MINF 008 090 14 XXX XX |
| | 19 | | 118 | 276 | 368 | 412 | 858 | MINF 008 090 19 XXX XX |
| 100 | -- | -- | -- | -- | -- | -- | MINF 008 100 06 XXX XX | |
| | 09 | | 59 | 137 | 182 | 204 | 425 | MINF 008 100 09 XXX XX |
| | 14 | | 96 | 223 | 298 | 333 | 694 | MINF 008 100 14 XXX XX |
| | 19 | | 132 | 307 | 409 | 458 | 953 | MINF 008 100 19 XXX XX |
| 110 | -- | -- | -- | -- | -- | -- | MINF 008 110 06 XXX XX | |
| | 09 | | 65 | 151 | 201 | 225 | 468 | MINF 008 110 09 XXX XX |
| | 14 | | 105 | 246 | 327 | 367 | 763 | MINF 008 110 14 XXX XX |
| | 19 | | 145 | 337 | 449 | 504 | 1048 | MINF 008 110 19 XXX XX |
| 120 | -- | -- | -- | -- | -- | -- | MINF 008 120 06 XXX XX | |
| | 09 | | 70 | 164 | 219 | 245 | 510 | MINF 008 120 09 XXX XX |
| | 14 | | 115 | 268 | 357 | 400 | 833 | MINF 008 120 14 XXX XX |
| | 19 | | 158 | 368 | 490 | 550 | 1144 | MINF 008 120 19 XXX XX |
| 140 | -- | -- | -- | -- | -- | -- | MINF 008 140 06 XXX XX | |
| | 09 | | 82 | 192 | 255 | 286 | 595 | MINF 008 140 09 XXX XX |
| | 14 | | 134 | 313 | 417 | 467 | 972 | MINF 008 140 14 XXX XX |
| | 19 | | 184 | 429 | 572 | 641 | 1334 | MINF 008 140 19 XXX XX |
| 160 | -- | -- | -- | -- | -- | -- | MINF 008 160 06 XXX XX | |
| | 09 | | 94 | 219 | 292 | 327 | 680 | MINF 008 160 09 XXX XX |
| | 14 | | 153 | 357 | 476 | 533 | 1110 | MINF 008 160 14 XXX XX |
| | 19 | | 211 | 491 | 654 | 733 | 1525 | MINF 008 160 19 XXX XX |
| 180 | -- | -- | -- | -- | -- | -- | MINF 008 180 06 XXX XX | |
| | 09 | | 106 | 246 | 328 | 368 | 765 | MINF 008 180 09 XXX XX |
| | 14 | | 172 | 402 | 535 | 600 | 1249 | MINF 008 180 14 XXX XX |
| | 19 | | 237 | 552 | 735 | 824 | 1715 | MINF 008 180 19 XXX XX |
| 200 | -- | -- | -- | -- | -- | -- | MINF 008 200 06 XXX XX | |
| | 09 | | 117 | 274 | 364 | 408 | 850 | MINF 008 200 09 XXX XX |
| | 14 | | 192 | 447 | 595 | 667 | 1388 | MINF 008 200 14 XXX XX |
| | 19 | | 263 | 614 | 817 | 916 | 1906 | MINF 008 200 19 XXX XX |
| 220 | -- | -- | -- | -- | -- | -- | MINF 008 220 06 XXX XX | |
| | 09 | | 129 | 301 | 401 | 449 | 935 | MINF 008 220 09 XXX XX |
| | 14 | | 211 | 492 | 655 | 734 | 1527 | MINF 008 220 14 XXX XX |
| | 19 | | 289 | 675 | 899 | 1008 | 2097 | MINF 008 220 19 XXX XX |
| 240 | -- | -- | -- | -- | -- | -- | MINF 008 240 06 XXX XX | |
| | 09 | | 141 | 328 | 437 | 490 | 1020 | MINF 008 240 09 XXX XX |
| | 14 | | 230 | 536 | 714 | 801 | 1666 | MINF 008 240 14 XXX XX |
| | 19 | | 316 | 736 | 981 | 1099 | 2287 | MINF 008 240 19 XXX XX |
| 260 | -- | -- | -- | -- | -- | -- | MINF 008 260 06 XXX XX | |
| | 09 | | 153 | 356 | 474 | 531 | 1105 | MINF 008 260 09 XXX XX |
| | 14 | | 249 | 581 | 773 | 867 | 1804 | MINF 008 260 14 XXX XX |
| | 19 | | 342 | 798 | 1062 | 1191 | 2478 | MINF 008 260 19 XXX XX |
| 280 | -- | -- | -- | -- | -- | -- | MINF 008 280 06 XXX XX | |
| | 09 | | 164 | 383 | 510 | 572 | 1190 | MINF 008 280 09 XXX XX |
| | 14 | | 268 | 626 | 833 | 934 | 1943 | MINF 008 280 14 XXX XX |
| | 19 | | 368 | 859 | 1144 | 1282 | 2668 | MINF 008 280 19 XXX XX |
| 300 | -- | -- | -- | -- | -- | -- | MINF 008 300 06 XXX XX | |
| | 09 | | 176 | 410 | 547 | 613 | 1275 | MINF 008 300 09 XXX XX |
| | 14 | | 287 | 670 | 893 | 1000 | 2082 | MINF 008 300 14 XXX XX |
| | 19 | | 395 | 920 | 1226 | 1374 | 2859 | MINF 008 300 19 XXX XX |

code voeten invullen
kleurcode invullen

HOOGTE 013

| HOOGTE H | LENGTE L | TYPE T | VERWARMEN Kamertemp. 20°C | | | | | BESTELCODE |
|-----------------|-------------|-----------|------------------------------|-------|-------|-------|-------|------------------------|
| | | | 35/30 | 45/40 | 50/45 | 55/45 | 75/65 | |
| | | | Watt | Watt | Watt | Watt | Watt | |
| MINF 013 060 05 | 05 | | 27 | 64 | 85 | 95 | 197 | MINF 013 060 05 XXX XX |
| | 10 | | 42 | 97 | 130 | 146 | 303 | MINF 013 060 10 XXX XX |
| | 15 | | 70 | 164 | 218 | 244 | 508 | MINF 013 060 15 XXX XX |
| | 20 | | 99 | 231 | 308 | 345 | 717 | MINF 013 060 20 XXX XX |
| 070 05 | 05 | | 32 | 74 | 99 | 111 | 230 | MINF 013 070 05 XXX XX |
| | 10 | | 49 | 114 | 152 | 170 | 354 | MINF 013 070 10 XXX XX |
| | 15 | | 82 | 191 | 255 | 285 | 593 | MINF 013 070 15 XXX XX |
| | 20 | | 116 | 270 | 359 | 403 | 837 | MINF 013 070 20 XXX XX |
| 080 05 | 05 | | 37 | 85 | 113 | 127 | 263 | MINF 013 080 05 XXX XX |
| | 10 | | 56 | 130 | 173 | 194 | 404 | MINF 013 080 10 XXX XX |
| | 15 | | 94 | 219 | 291 | 326 | 678 | MINF 013 080 15 XXX XX |
| | 20 | | 132 | 308 | 410 | 460 | 956 | MINF 013 080 20 XXX XX |
| 090 05 | 05 | | 41 | 96 | 127 | 143 | 296 | MINF 013 090 05 XXX XX |
| | 10 | | 63 | 146 | 195 | 219 | 455 | MINF 013 090 10 XXX XX |
| | 15 | | 105 | 246 | 327 | 367 | 762 | MINF 013 090 15 XXX XX |
| | 20 | | 149 | 347 | 462 | 518 | 1076 | MINF 013 090 20 XXX XX |
| 100 05 | 05 | | 46 | 106 | 141 | 158 | 329 | MINF 013 100 05 XXX XX |
| | 10 | | 70 | 162 | 216 | 243 | 505 | MINF 013 100 10 XXX XX |
| | 15 | | 117 | 273 | 364 | 407 | 847 | MINF 013 100 15 XXX XX |
| | 20 | | 165 | 385 | 513 | 575 | 1195 | MINF 013 100 20 XXX XX |
| 110 05 | 05 | | 50 | 117 | 156 | 174 | 362 | MINF 013 110 05 XXX XX |
| | 10 | | 77 | 179 | 238 | 267 | 556 | MINF 013 110 10 XXX XX |
| | 15 | | 129 | 301 | 400 | 448 | 932 | MINF 013 110 15 XXX XX |
| | 20 | | 182 | 424 | 564 | 633 | 1315 | MINF 013 110 20 XXX XX |
| 120 05 | 05 | | 55 | 128 | 170 | 190 | 395 | MINF 013 120 05 XXX XX |
| | 10 | | 84 | 195 | 260 | 291 | 606 | MINF 013 120 10 XXX XX |
| | 15 | | 141 | 328 | 436 | 489 | 1016 | MINF 013 120 15 XXX XX |
| | 20 | | 198 | 462 | 616 | 690 | 1434 | MINF 013 120 20 XXX XX |
| 140 05 | 05 | | 64 | 149 | 198 | 222 | 461 | MINF 013 140 05 XXX XX |
| | 10 | | 97 | 227 | 303 | 340 | 707 | MINF 013 140 10 XXX XX |
| | 15 | | 164 | 382 | 509 | 570 | 1186 | MINF 013 140 15 XXX XX |
| | 20 | | 232 | 539 | 718 | 805 | 1673 | MINF 013 140 20 XXX XX |
| 160 05 | 05 | | 73 | 170 | 226 | 253 | 526 | MINF 013 160 05 XXX XX |
| | 10 | | 111 | 260 | 346 | 388 | 808 | MINF 013 160 10 XXX XX |
| | 15 | | 188 | 437 | 582 | 652 | 1355 | MINF 013 160 15 XXX XX |
| | 20 | | 265 | 617 | 821 | 920 | 1912 | MINF 013 160 20 XXX XX |
| 180 05 | 05 | | 82 | 191 | 255 | 285 | 592 | MINF 013 180 05 XXX XX |
| | 10 | | 125 | 292 | 389 | 437 | 909 | MINF 013 180 10 XXX XX |
| | 15 | | 211 | 492 | 655 | 734 | 1525 | MINF 013 180 15 XXX XX |
| | 20 | | 298 | 694 | 923 | 1035 | 2151 | MINF 013 180 20 XXX XX |
| 200 05 | 05 | | 91 | 213 | 283 | 317 | 658 | MINF 013 200 05 XXX XX |
| | 10 | | 139 | 325 | 433 | 485 | 1010 | MINF 013 200 10 XXX XX |
| | 15 | | 234 | 546 | 727 | 815 | 1694 | MINF 013 200 15 XXX XX |
| | 20 | | 331 | 771 | 1026 | 1150 | 2390 | MINF 013 200 20 XXX XX |
| 220 05 | 05 | | 101 | 234 | 311 | 349 | 724 | MINF 013 220 05 XXX XX |
| | 10 | | 153 | 357 | 476 | 534 | 1111 | MINF 013 220 10 XXX XX |
| | 15 | | 258 | 601 | 800 | 896 | 1863 | MINF 013 220 15 XXX XX |
| | 20 | | 364 | 848 | 1129 | 1265 | 2629 | MINF 013 220 20 XXX XX |
| 240 05 | 05 | | 110 | 255 | 340 | 381 | 790 | MINF 013 240 05 XXX XX |
| | 10 | | 167 | 390 | 519 | 582 | 1212 | MINF 013 240 10 XXX XX |
| | 15 | | 281 | 656 | 873 | 978 | 2033 | MINF 013 240 15 XXX XX |
| | 20 | | 397 | 925 | 1231 | 1380 | 2868 | MINF 013 240 20 XXX XX |
| 260 05 | 05 | | 119 | 276 | 368 | 412 | 855 | MINF 013 260 05 XXX XX |
| | 10 | | 181 | 422 | 563 | 631 | 1313 | MINF 013 260 10 XXX XX |
| | 15 | | 305 | 710 | 945 | 1059 | 2202 | MINF 013 260 15 XXX XX |
| | 20 | | 430 | 1002 | 1334 | 1495 | 3107 | MINF 013 260 20 XXX XX |
| 280 05 | 05 | | 128 | 298 | 396 | 444 | 921 | MINF 013 280 05 XXX XX |
| | 10 | | 195 | 455 | 606 | 679 | 1414 | MINF 013 280 10 XXX XX |
| | 15 | | 328 | 765 | 1018 | 1141 | 2372 | MINF 013 280 15 XXX XX |
| | 20 | | 463 | 1079 | 1436 | 1609 | 3346 | MINF 013 280 20 XXX XX |
| 300 05 | 05 | | 137 | 319 | 424 | 475 | 987 | MINF 013 300 05 XXX XX |
| | 10 | | 209 | 487 | 649 | 728 | 1515 | MINF 013 300 10 XXX XX |
| | 15 | | 352 | 819 | 1091 | 1222 | 2541 | MINF 013 300 15 XXX XX |
| | 20 | | 496 | 1156 | 1539 | 1724 | 3585 | MINF 013 300 20 XXX XX |

code voeten invullen
kleurcode invullen

MINI VRIJSTAAND VASTE VOETEN

TECHNISCHE TABEL

HOOGTE 023

| HOOGTE | LENGTE | TYPE | VERWARMEN Kamertemp. 20°C | | | | | BESTELCODE |
|----------|--------|------|------------------------------|-------|-------|-------|------------------------|------------------------|
| | | | 35/30 | 45/40 | 50/45 | 55/45 | 75/65 | |
| | | | Watt | Watt | Watt | Watt | Watt | |
| MINF 023 | 060 | 06 | 45 | 105 | 139 | 156 | 323 | MINF 023 060 06 XXX XX |
| | | 11 | 80 | 190 | 254 | 285 | 601 | MINF 023 060 11 XXX XX |
| | | 16 | 103 | 246 | 330 | 370 | 785 | MINF 023 060 16 XXX XX |
| | | 21 | 132 | 317 | 426 | 479 | 1021 | MINF 023 060 21 XXX XX |
| | 070 | 06 | 53 | 122 | 162 | 182 | 377 | MINF 023 070 06 XXX XX |
| | | 11 | 94 | 222 | 296 | 333 | 701 | MINF 023 070 11 XXX XX |
| | | 16 | 120 | 287 | 385 | 432 | 916 | MINF 023 070 16 XXX XX |
| | | 21 | 154 | 370 | 497 | 559 | 1191 | MINF 023 070 21 XXX XX |
| | 080 | 06 | 60 | 140 | 186 | 208 | 431 | MINF 023 080 06 XXX XX |
| | | 11 | 107 | 253 | 339 | 381 | 802 | MINF 023 080 11 XXX XX |
| | | 16 | 137 | 327 | 439 | 494 | 1046 | MINF 023 080 16 XXX XX |
| | | 21 | 176 | 423 | 568 | 639 | 1361 | MINF 023 080 21 XXX XX |
| | 090 | 06 | 68 | 157 | 209 | 234 | 485 | MINF 023 090 06 XXX XX |
| | | 11 | 121 | 285 | 381 | 428 | 902 | MINF 023 090 11 XXX XX |
| | | 16 | 155 | 368 | 494 | 555 | 1177 | MINF 023 090 16 XXX XX |
| | | 21 | 198 | 475 | 639 | 719 | 1531 | MINF 023 090 21 XXX XX |
| | 100 | 06 | 75 | 174 | 232 | 260 | 539 | MINF 023 100 06 XXX XX |
| | | 11 | 134 | 317 | 424 | 476 | 1002 | MINF 023 100 11 XXX XX |
| | | 16 | 172 | 409 | 549 | 617 | 1308 | MINF 023 100 16 XXX XX |
| | | 21 | 220 | 528 | 710 | 799 | 1701 | MINF 023 100 21 XXX XX |
| | 110 | 06 | 83 | 192 | 255 | 286 | 593 | MINF 023 110 06 XXX XX |
| 11 | | 147 | 348 | 466 | 523 | 1102 | MINF 023 110 11 XXX XX | |
| 16 | | 189 | 450 | 604 | 679 | 1439 | MINF 023 110 16 XXX XX | |
| 21 | | 243 | 581 | 781 | 878 | 1871 | MINF 023 110 21 XXX XX | |
| 120 | 06 | 90 | 209 | 279 | 312 | 647 | MINF 023 120 06 XXX XX | |
| | 11 | 161 | 380 | 508 | 571 | 1202 | MINF 023 120 11 XXX XX | |
| | 16 | 206 | 491 | 659 | 741 | 1570 | MINF 023 120 16 XXX XX | |
| | 21 | 265 | 634 | 852 | 958 | 2041 | MINF 023 120 21 XXX XX | |
| 140 | 06 | 105 | 244 | 325 | 364 | 755 | MINF 023 140 06 XXX XX | |
| | 11 | 188 | 443 | 593 | 666 | 1403 | MINF 023 140 11 XXX XX | |
| | 16 | 241 | 573 | 769 | 864 | 1831 | MINF 023 140 16 XXX XX | |
| | 21 | 309 | 739 | 994 | 1118 | 2381 | MINF 023 140 21 XXX XX | |
| 160 | 06 | 120 | 279 | 371 | 416 | 862 | MINF 023 160 06 XXX XX | |
| | 11 | 214 | 507 | 678 | 761 | 1603 | MINF 023 160 11 XXX XX | |
| | 16 | 275 | 655 | 879 | 988 | 2093 | MINF 023 160 16 XXX XX | |
| | 21 | 353 | 845 | 1136 | 1278 | 2722 | MINF 023 160 21 XXX XX | |
| 180 | 06 | 135 | 314 | 418 | 468 | 970 | MINF 023 180 06 XXX XX | |
| | 11 | 241 | 570 | 763 | 857 | 1804 | MINF 023 180 11 XXX XX | |
| | 16 | 309 | 737 | 988 | 1111 | 2354 | MINF 023 180 16 XXX XX | |
| | 21 | 397 | 951 | 1278 | 1438 | 3062 | MINF 023 180 21 XXX XX | |
| 200 | 06 | 150 | 349 | 464 | 520 | 1078 | MINF 023 200 06 XXX XX | |
| | 11 | 268 | 633 | 847 | 952 | 2004 | MINF 023 200 11 XXX XX | |
| | 16 | 344 | 819 | 1098 | 1234 | 2616 | MINF 023 200 16 XXX XX | |
| | 21 | 441 | 1057 | 1420 | 1597 | 3402 | MINF 023 200 21 XXX XX | |
| 220 | 06 | 165 | 384 | 511 | 572 | 1186 | MINF 023 220 06 XXX XX | |
| | 11 | 295 | 697 | 932 | 1047 | 2204 | MINF 023 220 11 XXX XX | |
| | 16 | 378 | 901 | 1208 | 1358 | 2878 | MINF 023 220 16 XXX XX | |
| | 21 | 485 | 1162 | 1562 | 1757 | 3742 | MINF 023 220 21 XXX XX | |
| 240 | 06 | 180 | 419 | 557 | 624 | 1294 | MINF 023 240 06 XXX XX | |
| | 11 | 321 | 760 | 1017 | 1142 | 2405 | MINF 023 240 11 XXX XX | |
| | 16 | 413 | 983 | 1318 | 1481 | 3139 | MINF 023 240 16 XXX XX | |
| | 21 | 529 | 1268 | 1704 | 1916 | 4082 | MINF 023 240 21 XXX XX | |
| 260 | 06 | 195 | 454 | 603 | 676 | 1401 | MINF 023 260 06 XXX XX | |
| | 11 | 348 | 823 | 1102 | 1237 | 2605 | MINF 023 260 11 XXX XX | |
| | 16 | 447 | 1065 | 1428 | 1605 | 3401 | MINF 023 260 16 XXX XX | |
| | 21 | 573 | 1374 | 1846 | 2076 | 4423 | MINF 023 260 21 XXX XX | |
| 280 | 06 | 210 | 489 | 650 | 728 | 1509 | MINF 023 280 06 XXX XX | |
| | 11 | 375 | 887 | 1187 | 1332 | 2806 | MINF 023 280 11 XXX XX | |
| | 16 | 481 | 1146 | 1538 | 1728 | 3662 | MINF 023 280 16 XXX XX | |
| | 21 | 617 | 1479 | 1988 | 2236 | 4763 | MINF 023 280 21 XXX XX | |
| 300 | 06 | 225 | 523 | 696 | 780 | 1617 | MINF 023 300 06 XXX XX | |
| | 11 | 402 | 950 | 1271 | 1427 | 3006 | MINF 023 300 11 XXX XX | |
| | 16 | 516 | 1228 | 1648 | 1852 | 3924 | MINF 023 300 16 XXX XX | |
| | 21 | 661 | 1585 | 2130 | 2396 | 5103 | MINF 023 300 21 XXX XX | |

code voeten invullen
kleurcode invullen

HOOGTE 028

| HOOGTE | LENGTE | TYPE | VERWARMEN Kamertemp. 20°C | | | | | BESTELCODE |
|----------|--------|------|------------------------------|-------|-------|-------|------------------------|------------------------|
| | | | 35/30 | 45/40 | 50/45 | 55/45 | 75/65 | |
| | | | Watt | Watt | Watt | Watt | Watt | |
| MINF 028 | 060 | 06 | 48 | 111 | 148 | 166 | 342 | MINF 028 060 06 XXX XX |
| | | 11 | 87 | 206 | 276 | 310 | 653 | MINF 028 060 11 XXX XX |
| | | 16 | 113 | 269 | 361 | 405 | 860 | MINF 028 060 16 XXX XX |
| | | 21 | 145 | 349 | 469 | 528 | 1127 | MINF 028 060 21 XXX XX |
| | 070 | 06 | 56 | 130 | 173 | 193 | 399 | MINF 028 070 06 XXX XX |
| | | 11 | 102 | 241 | 322 | 362 | 762 | MINF 028 070 11 XXX XX |
| | | 16 | 131 | 313 | 421 | 473 | 1003 | MINF 028 070 16 XXX XX |
| | | 21 | 170 | 407 | 548 | 616 | 1315 | MINF 028 070 21 XXX XX |
| | 080 | 06 | 64 | 149 | 197 | 221 | 456 | MINF 028 080 06 XXX XX |
| | | 11 | 116 | 275 | 368 | 414 | 871 | MINF 028 080 11 XXX XX |
| | | 16 | 150 | 358 | 481 | 540 | 1146 | MINF 028 080 16 XXX XX |
| | | 21 | 194 | 465 | 626 | 704 | 1503 | MINF 028 080 21 XXX XX |
| | 090 | 06 | 72 | 167 | 222 | 248 | 513 | MINF 028 090 06 XXX XX |
| | | 11 | 131 | 310 | 414 | 465 | 980 | MINF 028 090 11 XXX XX |
| | | 16 | 169 | 403 | 541 | 608 | 1290 | MINF 028 090 16 XXX XX |
| | | 21 | 218 | 523 | 704 | 792 | 1691 | MINF 028 090 21 XXX XX |
| | 100 | 06 | 80 | 186 | 247 | 276 | 570 | MINF 028 100 06 XXX XX |
| | | 11 | 146 | 344 | 461 | 517 | 1089 | MINF 028 100 11 XXX XX |
| | | 16 | 188 | 448 | 601 | 676 | 1433 | MINF 028 100 16 XXX XX |
| | | 21 | 242 | 582 | 782 | 880 | 1879 | MINF 028 100 21 XXX XX |
| | 110 | 06 | 88 | 204 | 271 | 304 | 627 | MINF 028 110 06 XXX XX |
| 11 | | 160 | 379 | 507 | 569 | 1198 | MINF 028 110 11 XXX XX | |
| 16 | | 207 | 493 | 661 | 743 | 1576 | MINF 028 110 16 XXX XX | |
| 21 | | 266 | 640 | 861 | 968 | 2067 | MINF 028 110 21 XXX XX | |
| 120 | 06 | 96 | 223 | 296 | 331 | 684 | MINF 028 120 06 XXX XX | |
| | 11 | 175 | 413 | 553 | 621 | 1307 | MINF 028 120 11 XXX XX | |
| | 16 | 225 | 538 | 721 | 811 | 1720 | MINF 028 120 16 XXX XX | |
| | 21 | 291 | 698 | 939 | 1056 | 2255 | MINF 028 120 21 XXX XX | |
| 140 | 06 | 112 | 260 | 345 | 386 | 798 | MINF 028 140 06 XXX XX | |
| | 11 | 204 | 482 | 645 | 724 | 1525 | MINF 028 140 11 XXX XX | |
| | 16 | 263 | 627 | 841 | 946 | 2006 | MINF 028 140 16 XXX XX | |
| | 21 | 339 | 814 | 1095 | 1233 | 2631 | MINF 028 140 21 XXX XX | |
| 160 | 06 | 129 | 297 | 395 | 442 | 912 | MINF 028 160 06 XXX XX | |
| | 11 | 233 | 551 | 737 | 827 | 1742 | MINF 028 160 11 XXX XX | |
| | 16 | 301 | 717 | 962 | 1081 | 2293 | MINF 028 160 16 XXX XX | |
| | 21 | 387 | 931 | 1252 | 1408 | 3006 | MINF 028 160 21 XXX XX | |
| 180 | 06 | 145 | 334 | 444 | 497 | 1026 | MINF 028 180 06 XXX XX | |
| | 11 | 262 | 619 | 829 | 931 | 1960 | MINF 028 180 11 XXX XX | |
| | 16 | 338 | 806 | 1082 | 1216 | 2579 | MINF 028 180 16 XXX XX | |
| | 21 | 436 | 1047 | 1408 | 1584 | 3382 | MINF 028 180 21 XXX XX | |
| 200 | 06 | 161 | 371 | 493 | 552 | 1140 | MINF 028 200 06 XXX XX | |
| | 11 | 291 | 688 | 921 | 1034 | 2178 | MINF 028 200 11 XXX XX | |
| | 16 | 376 | 896 | 1202 | 1351 | 2866 | MINF 028 200 16 XXX XX | |
| | 21 | 484 | 1163 | 1565 | 1761 | 3758 | MINF 028 200 21 XXX XX | |
| 220 | 06 | 177 | 409 | 542 | 607 | 1254 | MINF 028 220 06 XXX XX | |
| | 11 | 320 | 757 | 1013 | 1138 | 2396 | MINF 028 220 11 XXX XX | |
| | 16 | 413 | 985 | 1322 | 1486 | 3153 | MINF 028 220 16 XXX XX | |
| | 21 | 533 | 1280 | 1721 | 1937 | 4134 | MINF 028 220 21 XXX XX | |
| 240 | 06 | 193 | 446 | 592 | 662 | 1368 | MINF 028 240 06 XXX XX | |
| | 11 | 349 | 826 | 1105 | 1241 | 2614 | MINF 028 240 11 XXX XX | |
| | 16 | 451 | 1075 | 1442 | 1621 | 3439 | MINF 028 240 16 XXX XX | |
| | 21 | 581 | 1396 | 1878 | 2113 | 4510 | MINF 028 240 21 XXX XX | |
| 260 | 06 | 209 | 483 | 641 | 718 | 1482 | MINF 028 260 06 XXX XX | |
| | 11 | 378 | 895 | 1197 | 1344 | 2831 | MINF 028 260 11 XXX XX | |
| | 16 | 488 | 1165 | 1563 | 1756 | 3726 | MINF 028 260 16 XXX XX | |
| | 21 | 630 | 1512 | 2034 | 2289 | 4885 | MINF 028 260 21 XXX XX | |
| 280 | 06 | 225 | 520 | 690 | 773 | 1596 | MINF 028 280 06 XXX XX | |
| | 11 | 408 | 964 | 1289 | 1448 | 3049 | MINF 028 280 11 XXX XX | |
| | 16 | 526 | 1254 | 1683 | 1891 | 4012 | MINF 028 280 16 XXX XX | |
| | 21 | 678 | 1629 | 2191 | 2465 | 5261 | MINF 028 280 21 XXX XX | |
| 300 | 06 | 241 | 557 | 740 | 828 | 1710 | MINF 028 300 06 XXX XX | |
| | 11 | 437 | 1033 | 1382 | 1551 | 3267 | MINF 028 300 11 XXX XX | |
| | 16 | 564 | 1344 | 1803 | 2027 | 4299 | MINF 028 300 16 XXX XX | |
| | 21 | 727 | 1745 | 2347 | 2641 | 5637 | MINF 028 300 21 XXX XX | |

code voeten invullen
kleurcode invullen

MINI VRIJSTAAND VERSTELBARE VOETEN

TECHNISCHE TABEL

HOOGTE 008

| HOOGTE | LENGTE | TYPE | VERWARMEN Kamertemp. 20°C | | | | | BESTELCODE |
|--------------|--------|------|------------------------------|-------|-------|-------|------------------------|------------------------|
| | | | 35/30 | 45/40 | 50/45 | 55/45 | 75/65 | |
| | | | Watt | Watt | Watt | Watt | Watt | |
| MINF 008 060 | 09 | --- | --- | --- | --- | --- | MINF 008 060 06 XXX XX | |
| | 14 | 35 | 82 | 109 | 123 | 255 | MINF 008 060 09 XXX XX | |
| | 19 | 57 | 134 | 178 | 200 | 416 | MINF 008 060 14 XXX XX | |
| | 09 | 79 | 184 | 245 | 275 | 572 | MINF 008 060 19 XXX XX | |
| | 070 | --- | --- | --- | --- | --- | MINF 008 070 06 XXX XX | |
| 070 | 09 | 41 | 96 | 128 | 143 | 298 | MINF 008 070 09 XXX XX | |
| | 14 | 67 | 156 | 208 | 234 | 486 | MINF 008 070 14 XXX XX | |
| | 19 | 92 | 215 | 286 | 321 | 667 | MINF 008 070 19 XXX XX | |
| | 080 | --- | --- | --- | --- | --- | MINF 008 080 06 XXX XX | |
| | 080 | 09 | 47 | 109 | 146 | 163 | 340 | MINF 008 080 09 XXX XX |
| 14 | | 77 | 179 | 238 | 267 | 555 | MINF 008 080 14 XXX XX | |
| 19 | | 105 | 245 | 327 | 366 | 762 | MINF 008 080 19 XXX XX | |
| 090 | | --- | --- | --- | --- | --- | MINF 008 090 06 XXX XX | |
| 090 | | 09 | 53 | 123 | 164 | 184 | 383 | MINF 008 090 09 XXX XX |
| | 14 | 86 | 201 | 268 | 300 | 625 | MINF 008 090 14 XXX XX | |
| | 19 | 118 | 276 | 368 | 412 | 858 | MINF 008 090 19 XXX XX | |
| | 100 | --- | --- | --- | --- | --- | MINF 008 100 06 XXX XX | |
| | 100 | 09 | 59 | 137 | 182 | 204 | 425 | MINF 008 100 09 XXX XX |
| 14 | | 96 | 223 | 298 | 333 | 694 | MINF 008 100 14 XXX XX | |
| 19 | | 132 | 307 | 409 | 458 | 953 | MINF 008 100 19 XXX XX | |
| 110 | | --- | --- | --- | --- | --- | MINF 008 110 06 XXX XX | |
| 110 | | 09 | 65 | 151 | 201 | 225 | 468 | MINF 008 110 09 XXX XX |
| | 14 | 105 | 246 | 327 | 367 | 763 | MINF 008 110 14 XXX XX | |
| | 19 | 145 | 337 | 449 | 504 | 1048 | MINF 008 110 19 XXX XX | |
| | 120 | --- | --- | --- | --- | --- | MINF 008 120 06 XXX XX | |
| | 120 | 09 | 70 | 164 | 219 | 245 | 510 | MINF 008 120 09 XXX XX |
| 14 | | 115 | 268 | 357 | 400 | 833 | MINF 008 120 14 XXX XX | |
| 19 | | 158 | 368 | 490 | 550 | 1144 | MINF 008 120 19 XXX XX | |
| 140 | | --- | --- | --- | --- | --- | MINF 008 140 06 XXX XX | |
| 140 | | 09 | 82 | 192 | 255 | 286 | 595 | MINF 008 140 09 XXX XX |
| | 14 | 134 | 313 | 417 | 467 | 972 | MINF 008 140 14 XXX XX | |
| | 19 | 184 | 429 | 572 | 641 | 1334 | MINF 008 140 19 XXX XX | |
| | 160 | --- | --- | --- | --- | --- | MINF 008 160 06 XXX XX | |
| | 160 | 09 | 94 | 219 | 292 | 327 | 680 | MINF 008 160 09 XXX XX |
| 14 | | 153 | 357 | 476 | 533 | 1110 | MINF 008 160 14 XXX XX | |
| 19 | | 211 | 491 | 654 | 733 | 1525 | MINF 008 160 19 XXX XX | |
| 180 | | --- | --- | --- | --- | --- | MINF 008 180 06 XXX XX | |
| 180 | | 09 | 106 | 246 | 328 | 368 | 765 | MINF 008 180 09 XXX XX |
| | 14 | 172 | 402 | 535 | 600 | 1249 | MINF 008 180 14 XXX XX | |
| | 19 | 237 | 552 | 735 | 824 | 1715 | MINF 008 180 19 XXX XX | |
| | 200 | --- | --- | --- | --- | --- | MINF 008 200 06 XXX XX | |
| | 200 | 09 | 117 | 274 | 364 | 408 | 850 | MINF 008 200 09 XXX XX |
| 14 | | 192 | 447 | 595 | 667 | 1388 | MINF 008 200 14 XXX XX | |
| 19 | | 263 | 614 | 817 | 916 | 1906 | MINF 008 200 19 XXX XX | |
| 220 | | --- | --- | --- | --- | --- | MINF 008 220 06 XXX XX | |
| 220 | | 09 | 129 | 301 | 401 | 449 | 935 | MINF 008 220 09 XXX XX |
| | 14 | 211 | 492 | 655 | 734 | 1527 | MINF 008 220 14 XXX XX | |
| | 19 | 289 | 675 | 899 | 1008 | 2097 | MINF 008 220 19 XXX XX | |
| | 240 | --- | --- | --- | --- | --- | MINF 008 240 06 XXX XX | |
| | 240 | 09 | 141 | 328 | 437 | 490 | 1020 | MINF 008 240 09 XXX XX |
| 14 | | 230 | 536 | 714 | 801 | 1666 | MINF 008 240 14 XXX XX | |
| 19 | | 316 | 736 | 981 | 1099 | 2287 | MINF 008 240 19 XXX XX | |
| 260 | | --- | --- | --- | --- | --- | MINF 008 260 06 XXX XX | |
| 260 | | 09 | 153 | 356 | 474 | 531 | 1105 | MINF 008 260 09 XXX XX |
| | 14 | 249 | 581 | 773 | 867 | 1804 | MINF 008 260 14 XXX XX | |
| | 19 | 342 | 798 | 1062 | 1191 | 2478 | MINF 008 260 19 XXX XX | |
| | 280 | --- | --- | --- | --- | --- | MINF 008 280 06 XXX XX | |
| | 280 | 09 | 164 | 383 | 510 | 572 | 1190 | MINF 008 280 09 XXX XX |
| 14 | | 268 | 626 | 833 | 934 | 1943 | MINF 008 280 14 XXX XX | |
| 19 | | 368 | 859 | 1144 | 1282 | 2668 | MINF 008 280 19 XXX XX | |
| 300 | | --- | --- | --- | --- | --- | MINF 008 300 06 XXX XX | |
| 300 | | 09 | 176 | 410 | 547 | 613 | 1275 | MINF 008 300 09 XXX XX |
| | 14 | 287 | 670 | 893 | 1000 | 2082 | MINF 008 300 14 XXX XX | |
| | 19 | 395 | 920 | 1226 | 1374 | 2859 | MINF 008 300 19 XXX XX | |

code voeten invullen
kleurcode invullen

HOOGTE 013

| HOOGTE | LENGTE | TYPE | VERWARMEN Kamertemp. 20°C | | | | | BESTELCODE |
|-----------------|--------|------|------------------------------|-------|-------|-------|------------------------|------------|
| | | | 35/30 | 45/40 | 50/45 | 55/45 | 75/65 | |
| | | | Watt | Watt | Watt | Watt | Watt | |
| MINF 013 060 05 | 09 | 27 | 64 | 85 | 95 | 197 | MINF 013 060 05 XXX XX | |
| | 10 | 42 | 97 | 130 | 146 | 303 | MINF 013 060 10 XXX XX | |
| | 15 | 70 | 164 | 218 | 244 | 508 | MINF 013 060 15 XXX XX | |
| | 20 | 99 | 231 | 308 | 345 | 717 | MINF 013 060 20 XXX XX | |
| | 070 | --- | --- | --- | --- | --- | MINF 013 070 05 XXX XX | |
| 070 | 09 | 32 | 74 | 99 | 111 | 230 | MINF 013 070 09 XXX XX | |
| | 10 | 49 | 114 | 152 | 170 | 354 | MINF 013 070 10 XXX XX | |
| | 15 | 82 | 191 | 255 | 285 | 593 | MINF 013 070 15 XXX XX | |
| | 20 | 116 | 270 | 359 | 403 | 837 | MINF 013 070 20 XXX XX | |
| | 080 | --- | --- | --- | --- | --- | MINF 013 080 05 XXX XX | |
| 080 | 09 | 37 | 85 | 113 | 127 | 263 | MINF 013 080 09 XXX XX | |
| | 10 | 56 | 130 | 173 | 194 | 404 | MINF 013 080 10 XXX XX | |
| | 15 | 94 | 219 | 291 | 326 | 678 | MINF 013 080 15 XXX XX | |
| | 20 | 132 | 308 | 410 | 460 | 956 | MINF 013 080 20 XXX XX | |
| | 090 | --- | --- | --- | --- | --- | MINF 013 090 05 XXX XX | |
| 090 | 09 | 41 | 96 | 127 | 143 | 296 | MINF 013 090 09 XXX XX | |
| | 10 | 63 | 146 | 195 | 219 | 455 | MINF 013 090 10 XXX XX | |
| | 15 | 105 | 246 | 327 | 367 | 762 | MINF 013 090 15 XXX XX | |
| | 20 | 149 | 347 | 462 | 518 | 1076 | MINF 013 090 20 XXX XX | |
| | 100 | --- | --- | --- | --- | --- | MINF 013 100 05 XXX XX | |
| 100 | 09 | 46 | 106 | 141 | 158 | 329 | MINF 013 100 09 XXX XX | |
| | 10 | 70 | 162 | 216 | 243 | 505 | MINF 013 100 10 XXX XX | |
| | 15 | 117 | 273 | 364 | 407 | 847 | MINF 013 100 15 XXX XX | |
| | 20 | 165 | 385 | 513 | 575 | 1195 | MINF 013 100 20 XXX XX | |
| | 110 | --- | --- | --- | --- | --- | MINF 013 110 05 XXX XX | |
| 110 | 09 | 50 | 117 | 156 | 174 | 362 | MINF 013 110 09 XXX XX | |
| | 10 | 77 | 179 | 238 | 267 | 556 | MINF 013 110 10 XXX XX | |
| | 15 | 129 | 301 | 400 | 448 | 932 | MINF 013 110 15 XXX XX | |
| | 20 | 182 | 424 | 564 | 633 | 1315 | MINF 013 110 20 XXX XX | |
| | 120 | --- | --- | --- | --- | --- | MINF 013 120 05 XXX XX | |
| 120 | 09 | 55 | 128 | 170 | 190 | 395 | MINF 013 120 09 XXX XX | |
| | 10 | 84 | 195 | 260 | 291 | 606 | MINF 013 120 10 XXX XX | |
| | 15 | 141 | 328 | 436 | 489 | 1016 | MINF 013 120 15 XXX XX | |
| | 20 | 198 | 462 | 616 | 690 | 1434 | MINF 013 120 20 XXX XX | |
| | 140 | --- | --- | --- | --- | --- | MINF 013 140 05 XXX XX | |
| 140 | 09 | 64 | 149 | 198 | 222 | 461 | MINF 013 140 09 XXX XX | |
| | 10 | 97 | 227 | 303 | 340 | 707 | MINF 013 140 10 XXX XX | |
| | 15 | 164 | 382 | 509 | 570 | 1186 | MINF 013 140 15 XXX XX | |
| | 20 | 232 | 539 | 718 | 805 | 1673 | MINF 013 140 20 XXX XX | |
| | 160 | --- | --- | --- | --- | --- | MINF 013 160 05 XXX XX | |
| 160 | 09 | 73 | 170 | 226 | 253 | 526 | MINF 013 160 09 XXX XX | |
| | 10 | 111 | 260 | 346 | 388 | 808 | MINF 013 160 10 XXX XX | |
| | 15 | 188 | 437 | 582 | 652 | 1355 | MINF 013 160 15 XXX XX | |
| | 20 | 265 | 617 | 821 | 920 | 1912 | MINF 013 160 20 XXX XX | |
| | 180 | --- | --- | --- | --- | --- | MINF 013 180 05 XXX XX | |
| 180 | 09 | 82 | 191 | 255 | 285 | 592 | MINF 013 180 09 XXX XX | |
| | 10 | 125 | 292 | 389 | 437 | 909 | MINF 013 180 10 XXX XX | |
| | 15 | 211 | 492 | 655 | 734 | 1525 | MINF 013 180 15 XXX XX | |
| | 20 | 298 | 694 | 923 | 1035 | 2151 | MINF 013 180 20 XXX XX | |
| | 200 | --- | --- | --- | --- | --- | MINF 013 200 05 XXX XX | |
| 200 | 09 | 91 | 213 | 283 | 317 | 658 | MINF 013 200 09 XXX XX | |
| | 10 | 139 | 325 | 433 | 485 | 1010 | MINF 013 200 10 XXX XX | |
| | 15 | 234 | 546 | 727 | 815 | 1694 | MINF 013 200 15 XXX XX | |
| | 20 | 331 | 771 | 1026 | 1150 | 2390 | MINF 013 200 20 XXX XX | |
| | 220 | --- | --- | --- | --- | --- | MINF 013 220 05 XXX XX | |
| 220 | 09 | 101 | 234 | 311 | 349 | 724 | MINF 013 220 09 XXX XX | |
| | 10 | 153 | 357 | 476 | 534 | 1111 | MINF 013 220 10 XXX XX | |
| | 15 | 258 | 601 | 800 | 896 | 1863 | MINF 013 220 15 XXX XX | |
| | 20 | 364 | 848 | 1129 | 1265 | 2629 | MINF 013 220 20 XXX XX | |
| | 240 | --- | --- | --- | --- | --- | MINF 013 240 05 XXX XX | |
| 240 | 09 | 110 | 255 | 340 | 381 | 790 | MINF 013 240 09 XXX XX | |
| | 10 | 167 | 390 | 519 | 582 | 1212 | MINF 013 240 10 XXX XX | |
| | 15 | 281 | 656 | 873 | 978 | 2033 | MINF 013 240 15 XXX XX | |
| | 20 | 397 | 925 | 1231 | 1380 | 2868 | MINF 013 240 20 XXX XX | |
| | 260 | --- | --- | --- | --- | --- | MINF 013 260 05 XXX XX | |
| 260 | 09 | 119 | 276 | 368 | 412 | 855 | MINF 013 260 09 XXX XX | |
| | 10 | 181 | 422 | 563 | 631 | 1313 | MINF 013 260 10 XXX XX | |
| | 15 | 305 | 710 | 945 | 1059 | 2202 | MINF 013 260 15 XXX XX | |
| | 20 | 430 | 1002 | 1334 | 1495 | 3107 | MINF 013 260 20 XXX XX | |
| | 280 | --- | --- | --- | --- | --- | MINF 013 280 05 XXX XX | |
| 280 | 09 | 128 | 298 | 396 | 444 | 921 | MINF 013 280 09 XXX XX | |
| | 10 | 195 | 455 | 606 | 679 | 1414 | MINF 013 280 10 XXX XX | |
| | 15 | 328 | 765 | 1018 | 1141 | 2372 | MINF 013 280 15 XXX XX | |
| | 20 | 463 | 1079 | 1436 | 1609 | 3346 | MINF 013 280 20 XXX XX | |
| | 300 | --- | --- | --- | --- | --- | MINF 013 300 05 XXX XX | |
| 300 | 09 | 137 | 319 | 424 | 475 | 987 | MINF 013 300 09 XXX XX | |
| | 10 | 209 | 487 | 649 | 728 | 1515 | MINF 013 300 10 XXX XX | |
| | 15 | 352 | 819 | 1091 | 1222 | 2541 | MINF 013 300 15 XXX XX | |
| | 20 | 496 | 1156 | 1539 | 1724 | 3585 | MINF 013 300 20 XXX XX | |

code voeten invullen
kleurcode invullen

MINI VRIJSTAAND VERSTELBARE VOETEN

TECHNISCHE TABEL

HOOGTE 023

| HOOGTE | LENGTE | | TYPE | VERWARMEN Kamertemp. 20°C | | | | | BESTELCODE | |
|----------|--------|----|------|------------------------------|-------|-------|-------|------------------------|------------------------|-------|
| | H | L | | T | 35/30 | 45/40 | 50/45 | 55/45 | | 75/65 |
| | cm | cm | | | Watt | Watt | Watt | Watt | | Watt |
| MINF 023 | 060 | 06 | 06 | 45 | 105 | 139 | 156 | 323 | MINF 023 060 06 XXX XX | |
| | | | 11 | 80 | 190 | 254 | 285 | 601 | MINF 023 060 11 XXX XX | |
| | | | 16 | 103 | 246 | 330 | 370 | 785 | MINF 023 060 16 XXX XX | |
| | | | 21 | 132 | 317 | 426 | 479 | 1021 | MINF 023 060 21 XXX XX | |
| | 070 | 06 | 06 | 53 | 122 | 162 | 182 | 377 | MINF 023 070 06 XXX XX | |
| | | | 11 | 94 | 222 | 296 | 333 | 701 | MINF 023 070 11 XXX XX | |
| | | | 16 | 120 | 287 | 385 | 432 | 916 | MINF 023 070 16 XXX XX | |
| | | | 21 | 154 | 370 | 497 | 559 | 1191 | MINF 023 070 21 XXX XX | |
| | 080 | 06 | 06 | 60 | 140 | 186 | 208 | 431 | MINF 023 080 06 XXX XX | |
| | | | 11 | 107 | 253 | 339 | 381 | 802 | MINF 023 080 11 XXX XX | |
| | | | 16 | 137 | 327 | 439 | 494 | 1046 | MINF 023 080 16 XXX XX | |
| | | | 21 | 176 | 423 | 568 | 639 | 1361 | MINF 023 080 21 XXX XX | |
| 090 | 06 | 06 | 68 | 157 | 209 | 234 | 485 | MINF 023 090 06 XXX XX | | |
| | | 11 | 121 | 285 | 381 | 428 | 902 | MINF 023 090 11 XXX XX | | |
| | | 16 | 155 | 368 | 494 | 555 | 1177 | MINF 023 090 16 XXX XX | | |
| | | 21 | 198 | 475 | 639 | 719 | 1531 | MINF 023 090 21 XXX XX | | |
| 100 | 06 | 06 | 75 | 174 | 232 | 260 | 539 | MINF 023 100 06 XXX XX | | |
| | | 11 | 134 | 317 | 424 | 476 | 1002 | MINF 023 100 11 XXX XX | | |
| | | 16 | 172 | 409 | 549 | 617 | 1308 | MINF 023 100 16 XXX XX | | |
| | | 21 | 220 | 528 | 710 | 799 | 1701 | MINF 023 100 21 XXX XX | | |
| 110 | 06 | 06 | 83 | 192 | 255 | 286 | 593 | MINF 023 110 06 XXX XX | | |
| | | 11 | 147 | 348 | 466 | 523 | 1102 | MINF 023 110 11 XXX XX | | |
| | | 16 | 189 | 450 | 604 | 679 | 1439 | MINF 023 110 16 XXX XX | | |
| | | 21 | 243 | 581 | 781 | 878 | 1871 | MINF 023 110 21 XXX XX | | |
| 120 | 06 | 06 | 90 | 209 | 279 | 312 | 647 | MINF 023 120 06 XXX XX | | |
| | | 11 | 161 | 380 | 508 | 571 | 1202 | MINF 023 120 11 XXX XX | | |
| | | 16 | 206 | 491 | 659 | 741 | 1570 | MINF 023 120 16 XXX XX | | |
| | | 21 | 265 | 634 | 852 | 958 | 2041 | MINF 023 120 21 XXX XX | | |
| 140 | 06 | 06 | 105 | 244 | 325 | 364 | 755 | MINF 023 140 06 XXX XX | | |
| | | 11 | 188 | 443 | 593 | 666 | 1403 | MINF 023 140 11 XXX XX | | |
| | | 16 | 241 | 573 | 769 | 864 | 1831 | MINF 023 140 16 XXX XX | | |
| | | 21 | 309 | 739 | 994 | 1118 | 2381 | MINF 023 140 21 XXX XX | | |
| 160 | 06 | 06 | 120 | 279 | 371 | 416 | 862 | MINF 023 160 06 XXX XX | | |
| | | 11 | 214 | 507 | 678 | 761 | 1603 | MINF 023 160 11 XXX XX | | |
| | | 16 | 275 | 655 | 879 | 988 | 2093 | MINF 023 160 16 XXX XX | | |
| | | 21 | 353 | 845 | 1136 | 1278 | 2722 | MINF 023 160 21 XXX XX | | |
| 180 | 06 | 06 | 135 | 314 | 418 | 468 | 970 | MINF 023 180 06 XXX XX | | |
| | | 11 | 241 | 570 | 763 | 857 | 1804 | MINF 023 180 11 XXX XX | | |
| | | 16 | 309 | 737 | 988 | 1111 | 2354 | MINF 023 180 16 XXX XX | | |
| | | 21 | 397 | 951 | 1278 | 1438 | 3062 | MINF 023 180 21 XXX XX | | |
| 200 | 06 | 06 | 150 | 349 | 464 | 520 | 1078 | MINF 023 200 06 XXX XX | | |
| | | 11 | 268 | 633 | 847 | 952 | 2004 | MINF 023 200 11 XXX XX | | |
| | | 16 | 344 | 819 | 1098 | 1234 | 2616 | MINF 023 200 16 XXX XX | | |
| | | 21 | 441 | 1057 | 1420 | 1597 | 3402 | MINF 023 200 21 XXX XX | | |
| 220 | 06 | 06 | 165 | 384 | 511 | 572 | 1186 | MINF 023 220 06 XXX XX | | |
| | | 11 | 295 | 697 | 932 | 1047 | 2204 | MINF 023 220 11 XXX XX | | |
| | | 16 | 378 | 901 | 1208 | 1358 | 2878 | MINF 023 220 16 XXX XX | | |
| | | 21 | 485 | 1162 | 1562 | 1757 | 3742 | MINF 023 220 21 XXX XX | | |
| 240 | 06 | 06 | 180 | 419 | 557 | 624 | 1294 | MINF 023 240 06 XXX XX | | |
| | | 11 | 321 | 760 | 1017 | 1142 | 2405 | MINF 023 240 11 XXX XX | | |
| | | 16 | 413 | 983 | 1318 | 1481 | 3139 | MINF 023 240 16 XXX XX | | |
| | | 21 | 529 | 1268 | 1704 | 1916 | 4082 | MINF 023 240 21 XXX XX | | |
| 260 | 06 | 06 | 195 | 454 | 603 | 676 | 1401 | MINF 023 260 06 XXX XX | | |
| | | 11 | 348 | 823 | 1102 | 1237 | 2605 | MINF 023 260 11 XXX XX | | |
| | | 16 | 447 | 1065 | 1428 | 1605 | 3401 | MINF 023 260 16 XXX XX | | |
| | | 21 | 573 | 1374 | 1846 | 2076 | 4423 | MINF 023 260 21 XXX XX | | |
| 280 | 06 | 06 | 210 | 489 | 650 | 728 | 1509 | MINF 023 280 06 XXX XX | | |
| | | 11 | 375 | 887 | 1187 | 1332 | 2806 | MINF 023 280 11 XXX XX | | |
| | | 16 | 481 | 1146 | 1538 | 1728 | 3662 | MINF 023 280 16 XXX XX | | |
| | | 21 | 617 | 1479 | 1988 | 2236 | 4763 | MINF 023 280 21 XXX XX | | |
| 300 | 06 | 06 | 225 | 523 | 696 | 780 | 1617 | MINF 023 300 06 XXX XX | | |
| | | 11 | 402 | 950 | 1271 | 1427 | 3006 | MINF 023 300 11 XXX XX | | |
| | | 16 | 516 | 1228 | 1648 | 1852 | 3924 | MINF 023 300 16 XXX XX | | |
| | | 21 | 661 | 1585 | 2130 | 2396 | 5103 | MINF 023 300 21 XXX XX | | |

code voeten invullen
kleurcode invullen

HOOGTE 028

| HOOGTE | LENGTE | | TYPE | VERWARMEN Kamertemp. 20°C | | | | | BESTELCODE | |
|----------|--------|----|------|------------------------------|-------|-------|-------|------------------------|------------------------|-------|
| | H | L | | T | 35/30 | 45/40 | 50/45 | 55/45 | | 75/65 |
| | cm | cm | | | Watt | Watt | Watt | Watt | | Watt |
| MINF 028 | 060 | 06 | 06 | 48 | 111 | 148 | 166 | 342 | MINF 028 060 06 XXX XX | |
| | | | 11 | 87 | 206 | 276 | 310 | 653 | MINF 028 060 11 XXX XX | |
| | | | 16 | 113 | 269 | 361 | 405 | 860 | MINF 028 060 16 XXX XX | |
| | | | 21 | 145 | 349 | 469 | 528 | 1127 | MINF 028 060 21 XXX XX | |
| | 070 | 06 | 06 | 56 | 130 | 173 | 193 | 399 | MINF 028 070 06 XXX XX | |
| | | | 11 | 102 | 241 | 322 | 362 | 762 | MINF 028 070 11 XXX XX | |
| | | | 16 | 131 | 313 | 421 | 473 | 1003 | MINF 028 070 16 XXX XX | |
| | | | 21 | 170 | 407 | 548 | 616 | 1315 | MINF 028 070 21 XXX XX | |
| | 080 | 06 | 06 | 64 | 149 | 197 | 221 | 456 | MINF 028 080 06 XXX XX | |
| | | | 11 | 116 | 275 | 368 | 414 | 871 | MINF 028 080 11 XXX XX | |
| | | | 16 | 150 | 358 | 481 | 540 | 1146 | MINF 028 080 16 XXX XX | |
| | | | 21 | 194 | 465 | 626 | 704 | 1503 | MINF 028 080 21 XXX XX | |
| 090 | 06 | 06 | 72 | 167 | 222 | 248 | 513 | MINF 028 090 06 XXX XX | | |
| | | 11 | 131 | 310 | 414 | 465 | 980 | MINF 028 090 11 XXX XX | | |
| | | 16 | 169 | 403 | 541 | 608 | 1290 | MINF 028 090 16 XXX XX | | |
| | | 21 | 218 | 523 | 704 | 792 | 1691 | MINF 028 090 21 XXX XX | | |
| 100 | 06 | 06 | 80 | 186 | 247 | 276 | 570 | MINF 028 100 06 XXX XX | | |
| | | 11 | 146 | 344 | 461 | 517 | 1089 | MINF 028 100 11 XXX XX | | |
| | | 16 | 188 | 448 | 601 | 676 | 1433 | MINF 028 100 16 XXX XX | | |
| | | 21 | 242 | 582 | 782 | 880 | 1879 | MINF 028 100 21 XXX XX | | |
| 110 | 06 | 06 | 88 | 204 | 271 | 304 | 627 | MINF 028 110 06 XXX XX | | |
| | | 11 | 160 | 379 | 507 | 569 | 1198 | MINF 028 110 11 XXX XX | | |
| | | 16 | 207 | 493 | 661 | 743 | 1576 | MINF 028 110 16 XXX XX | | |
| | | 21 | 266 | 640 | 861 | 968 | 2067 | MINF 028 110 21 XXX XX | | |
| 120 | 06 | 06 | 96 | 223 | 296 | 331 | 684 | MINF 028 120 06 XXX XX | | |
| | | 11 | 175 | 413 | 553 | 621 | 1307 | MINF 028 120 11 XXX XX | | |
| | | 16 | 225 | 538 | 721 | 811 | 1720 | MINF 028 120 16 XXX XX | | |
| | | 21 | 291 | 698 | 939 | 1056 | 2255 | MINF 028 120 21 XXX XX | | |
| 140 | 06 | 06 | 112 | 260 | 345 | 386 | 798 | MINF 028 140 06 XXX XX | | |
| | | 11 | 204 | 482 | 645 | 724 | 1525 | MINF 028 140 11 XXX XX | | |
| | | 16 | 263 | 627 | 841 | 946 | 2006 | MINF 028 140 16 XXX XX | | |
| | | 21 | 339 | 814 | 1095 | 1233 | 2631 | MINF 028 140 21 XXX XX | | |
| 160 | 06 | 06 | 129 | 297 | 395 | 442 | 912 | MINF 028 160 06 XXX XX | | |
| | | 11 | 233 | 551 | 737 | 827 | 1742 | MINF 028 160 11 XXX XX | | |
| | | 16 | 301 | 717 | 962 | 1081 | 2293 | MINF 028 160 16 XXX XX | | |
| | | 21 | 387 | 931 | 1252 | 1408 | 3006 | MINF 028 160 21 XXX XX | | |
| 180 | 06 | 06 | 145 | 334 | 444 | 497 | 1026 | MINF 028 180 06 XXX XX | | |
| | | 11 | 262 | 619 | 829 | 931 | 1960 | MINF 028 180 11 XXX XX | | |
| | | 16 | 338 | 806 | 1082 | 1216 | 2579 | MINF 028 180 16 XXX XX | | |
| | | 21 | 436 | 1047 | 1408 | 1584 | 3382 | MINF 028 180 21 XXX XX | | |
| 200 | 06 | 06 | 161 | 371 | 493 | 552 | 1140 | MINF 028 200 06 XXX XX | | |
| | | 11 | 291 | 688 | 921 | 1034 | 2178 | MINF 028 200 11 XXX XX | | |
| | | 16 | 376 | 896 | 1202 | 1351 | 2866 | MINF 028 200 16 XXX XX | | |
| | | 21 | 484 | 1163 | 1565 | 1761 | 3758 | MINF 028 200 21 XXX XX | | |
| 220 | 06 | 06 | 177 | 409 | 542 | 607 | 1254 | MINF 028 220 06 XXX XX | | |
| | | 11 | 320 | 757 | 1013 | 1138 | 2396 | MINF 028 220 11 XXX XX | | |
| | | 16 | 413 | 985 | 1322 | 1486 | 3153 | MINF 028 220 16 XXX XX | | |
| | | 21 | 533 | 1280 | 1721 | 1937 | 4134 | MINF 028 220 21 XXX XX | | |
| 240 | 06 | 06 | 193 | 446 | 592 | 662 | 1368 | MINF 028 240 06 XXX XX | | |
| | | 11 | 349 | 826 | 1105 | 1241 | 2614 | MINF 028 240 11 XXX XX | | |
| | | 16 | 451 | 1075 | 1442 | 1621 | 3439 | MINF 028 240 16 XXX XX | | |
| | | 21 | 581 | 1396 | 1878 | 2113 | 4510 | MINF 028 240 21 XXX XX | | |
| 260 | 06 | 06 | 209 | 483 | 641 | 718 | 1482 | MINF 028 260 06 XXX XX | | |
| | | 11 | 378 | 895 | 1197 | 1344 | 2831 | MINF 028 260 11 XXX XX | | |
| | | 16 | 488 | 1165 | 1563 | 1756 | 3726 | MINF 028 260 16 XXX XX | | |
| | | 21 | 630 | 1512 | 2034 | 2289 | 4885 | MINF 028 260 21 XXX XX | | |
| 280 | 06 | 06 | 225 | 520 | 690 | 773 | 1596 | MINF 028 280 06 XXX XX | | |
| | | 11 | 408 | 964 | 1289 | 1448 | 3049 | MINF 028 280 11 XXX XX | | |
| | | 16 | 526 | 1254 | 1683 | 1891 | 4012 | MINF 028 280 16 XXX XX | | |
| | | 21 | 678 | 1629 | 2191 | 2465 | 5261 | MINF 028 280 21 XXX XX | | |
| 300 | 06 | 06 | 241 | 557 | 740 | 828 | 1710 | MINF 028 300 06 XXX XX | | |
| | | 11 | 437 | 1033 | 1382 | 1551 | 3267 | MINF 028 300 11 XXX XX | | |
| | | 16 | 564 | 1344 | 1803 | 2027 | 4299 | MINF 028 300 16 XXX XX | | |
| | | 21 | 727 | 1745 | 2347 | 2641 | 5637 | MINF 028 300 21 XXX XX | | |

code voeten invullen
kleurcode invullen

MINI VRIJSTAAND

ONDERDELEN

BEKLEDING

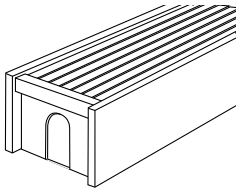

STANDAARD LEVERING:

- voorgemonteerde bekleding
- kleur 133, 001 of 145;
- meerprijs andere kleur

BESTELCODE



VASTE VOETEN

Type 05 / 06



Type 09 / 10 / 11



Type 14 / 15 : 16

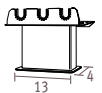

Type 19 / 20 / 21

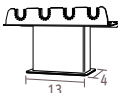

aantal voeten voor bekleding

- van 060 tot 160 cm: min. 2 stuks
- van 180 tot 300 cm: min. 3 stuks

Hoogte voet:

- FS: hoogte 65 mm (enkel voor Mini H008 en H013)
- FM: hoogte 100 mm
- FL: hoogte 120 mm

BESTELCODE

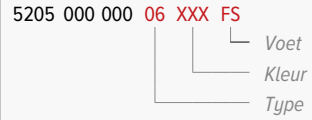

VERSTELBARE VOETEN

Type 05 / 06

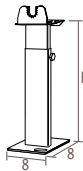

Type 09 / 10 / 11

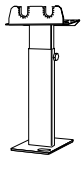

Type 14 / 15 : 16

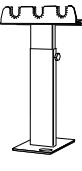

Type 19 / 20 / 21

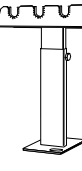

aantal voeten voor bekleding

- van 060 tot 160 cm: min. 2 stuks
- van 180 tot 300 cm: min. 3 stuks

Hoogte voet:

- AS: hoogte 135 mm tot 210 mm
- AL: hoogte 215 mm tot 340 mm

BESTELCODE

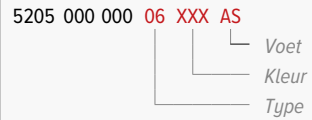

WARMTEWISSELAAR









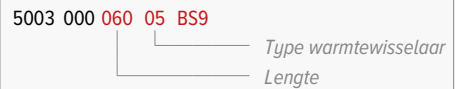



STANDAARD LEVERING:

- warmtewisselaar
- inclusief ontlufter en aftapstop

BESTELCODE



Overzicht type warmtewisselaars

| | Mini Type 05 | Mini Type 06 | Mini Type 09 | Mini Type 10 | Mini Type 11 | Mini Type 14 | Mini Type 15 | Mini Type 16 | Mini Type 19 | Mini Type 20 | Mini Type 21 |
|--------------------------|--|--|--|--|--|--|--|---|--|--|--|
| Hoogte 008 | | |  Type 09 | | |  Type 14 | | |  Type 19 | | |
| Hoogte 013 |  Type 05 | | |  Type 10 | | |  Type 15 | | |  Type 20 | |
| Hoogte 023 Hoogte 028 | |  Type 06 | | |  Type 11 | | |  Type 16 | | |  Type 21 |

De opgegeven vermogens bij ΔT 50 zijn exacte waarden, gemeten volgens EN442. Voor alle andere ΔT geeft deze tabel een berekende waarde aan de hand van een gemiddelde correctiefactor geldig voor alle afmetingen.

Op www.jaga.com/selection-tools/ kunt u berekeningstools downloaden met de exacte afgiftes. De online berekeningstools worden steeds up to date gehouden met de meest recente gegevens. Minieme afgifteverschillen tussen reeds gedrukte tabellen en de verschillende online berekeningstools zijn daarom volstrekt normaal en vallen binnen de door de norm vastgelegde toleranties.

GEMIDDELDE CORRECTIEFACTOREN STATISCHE PRODUCTEN VOLGENS EN442 - 75/65/20°C

Kamertemperatuur: 20°C

Gemiddelde N-waarde: 1.36

| | TR | 65 | 60 | 55 | 50 | 45 | 40 | 35 | 30 | 25 |
|----|----|------|------|------|------|------|------|------|------|------|
| TA | | | | | | | | | | |
| 75 | | 1.00 | 0.93 | 0.85 | 0.77 | 0.69 | 0.61 | 0.52 | 0.42 | 0.31 |
| 70 | | 0.94 | 0.87 | 0.79 | 0.72 | 0.64 | 0.56 | 0.48 | 0.39 | 0.28 |
| 65 | | | 0.80 | 0.74 | 0.67 | 0.60 | 0.52 | 0.44 | 0.35 | 0.25 |
| 60 | | | | 0.68 | 0.61 | 0.55 | 0.48 | 0.40 | 0.32 | 0.23 |
| 55 | | | | | 0.56 | 0.50 | 0.43 | 0.36 | 0.29 | 0.20 |
| 50 | | | | | | 0.44 | 0.38 | 0.32 | 0.25 | 0.18 |
| 45 | | | | | | | 0.34 | 0.28 | 0.22 | 0.15 |
| 40 | | | | | | | | 0.24 | 0.19 | 0.13 |
| 35 | | | | | | | | | 0.15 | 0.10 |
| 30 | | | | | | | | | | 0.07 |

Kamertemperatuur: 24°C

Gemiddelde N-waarde: 1.36

| | TR | 65 | 60 | 55 | 50 | 45 | 40 | 35 | 30 | 25 |
|----|----|------|------|------|------|------|------|------|------|------|
| TA | | | | | | | | | | |
| 75 | | 0.89 | 0.82 | 0.75 | 0.67 | 0.59 | 0.51 | 0.41 | 0.31 | 0.16 |
| 70 | | 0.83 | 0.76 | 0.69 | 0.62 | 0.54 | 0.47 | 0.38 | 0.28 | 0.14 |
| 65 | | | 0.70 | 0.64 | 0.57 | 0.50 | 0.43 | 0.35 | 0.25 | 0.12 |
| 60 | | | | 0.58 | 0.52 | 0.45 | 0.38 | 0.31 | 0.23 | 0.11 |
| 55 | | | | | 0.47 | 0.41 | 0.34 | 0.28 | 0.20 | 0.09 |
| 50 | | | | | | 0.36 | 0.30 | 0.24 | 0.17 | 0.08 |
| 45 | | | | | | | 0.26 | 0.20 | 0.14 | 0.06 |
| 40 | | | | | | | | 0.17 | 0.12 | 0.05 |
| 35 | | | | | | | | | 0.09 | 0.03 |
| 30 | | | | | | | | | | 0.02 |

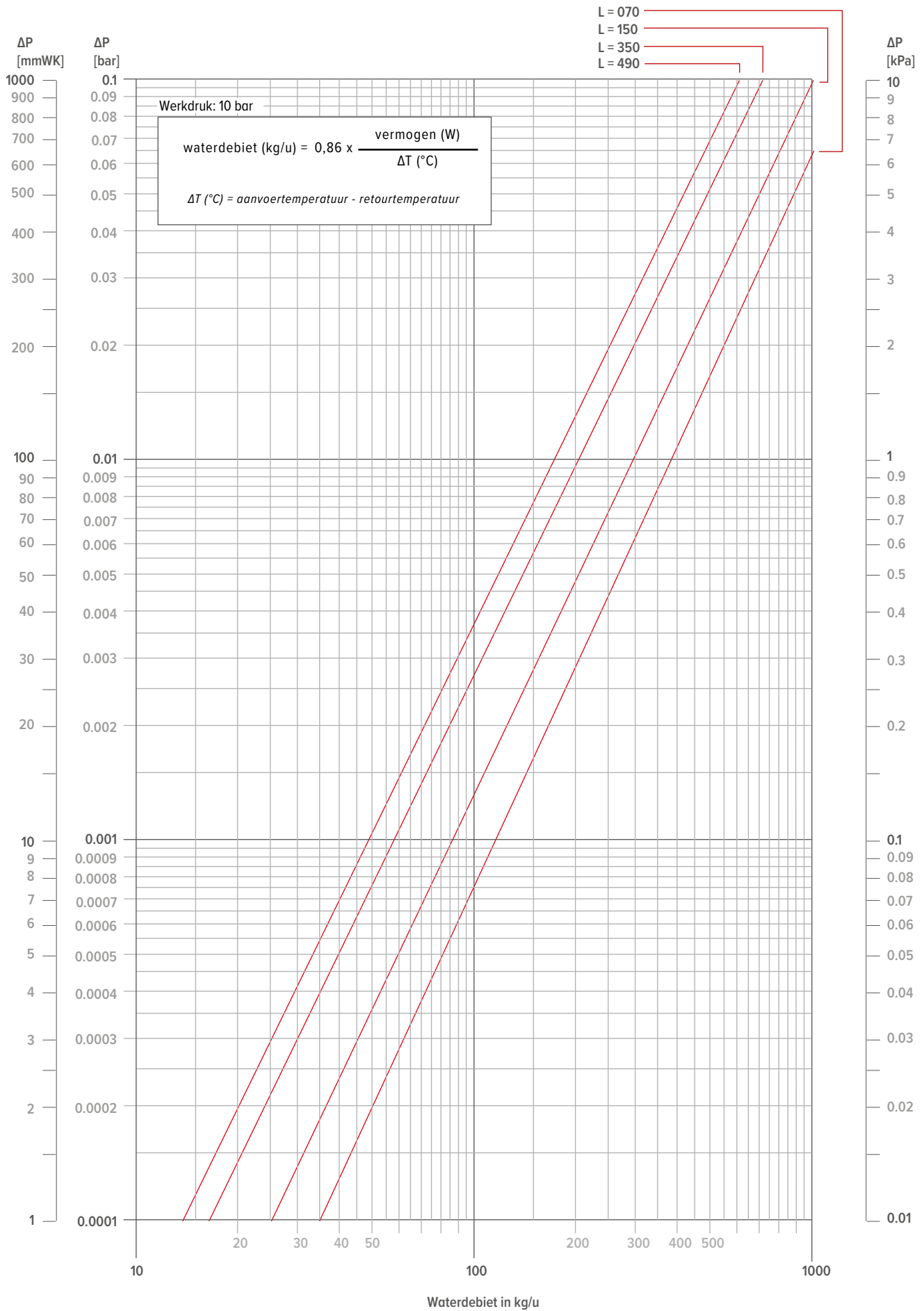

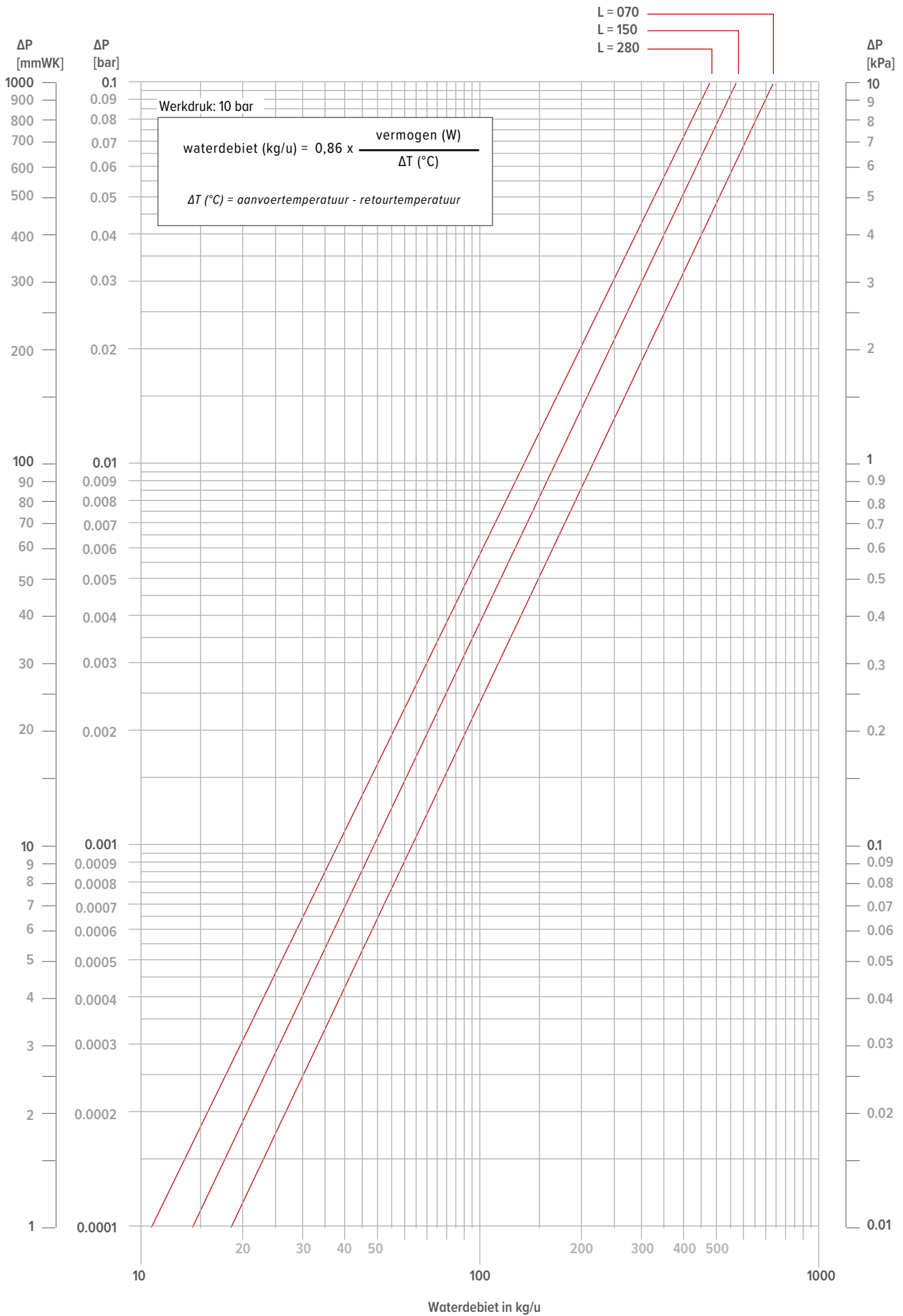

MINI VRIJSTAAND TYPE 09 DUBBELZIJDIG DRUKVERLIES TYPE 09 DUBBELZIJDIG

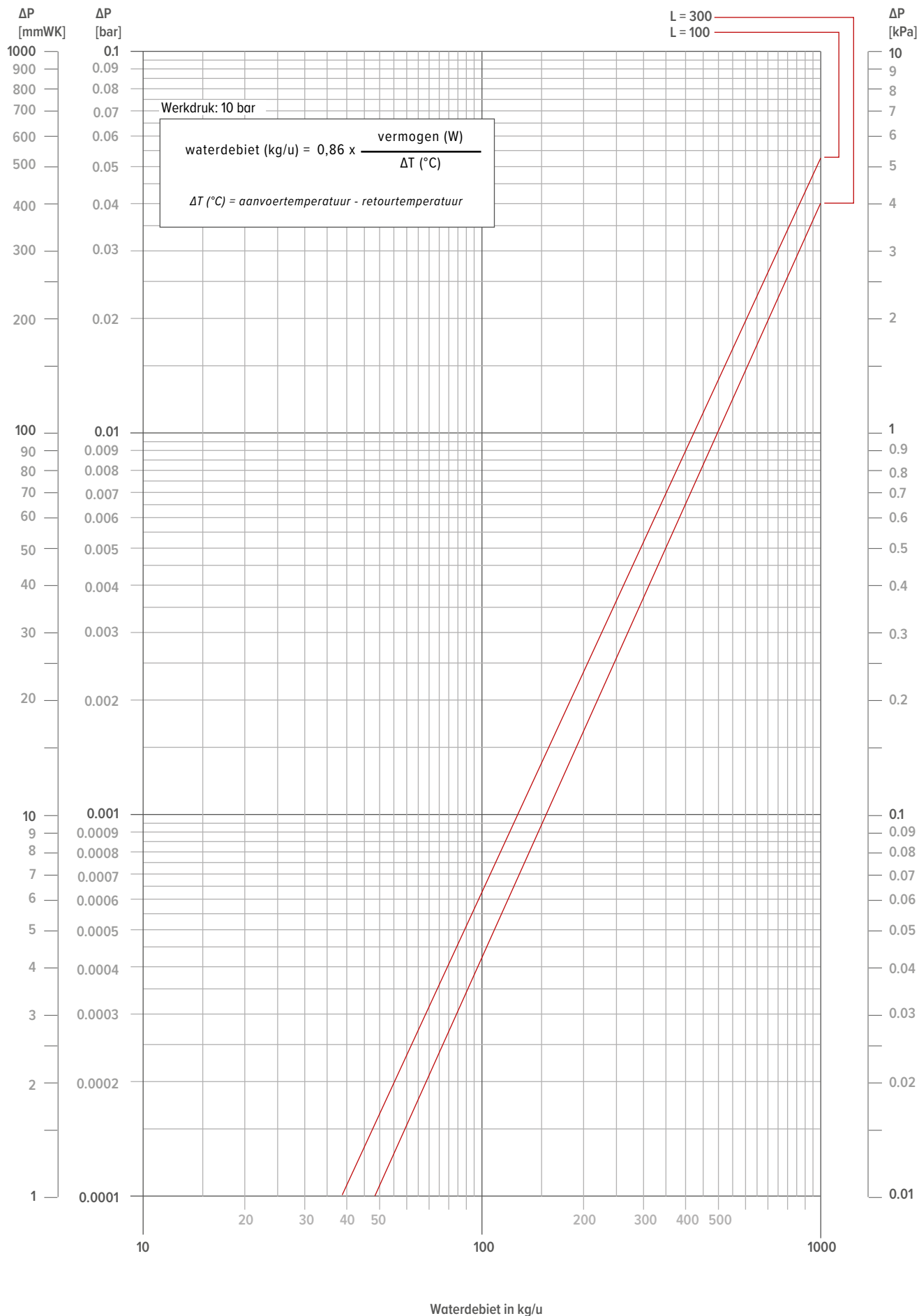

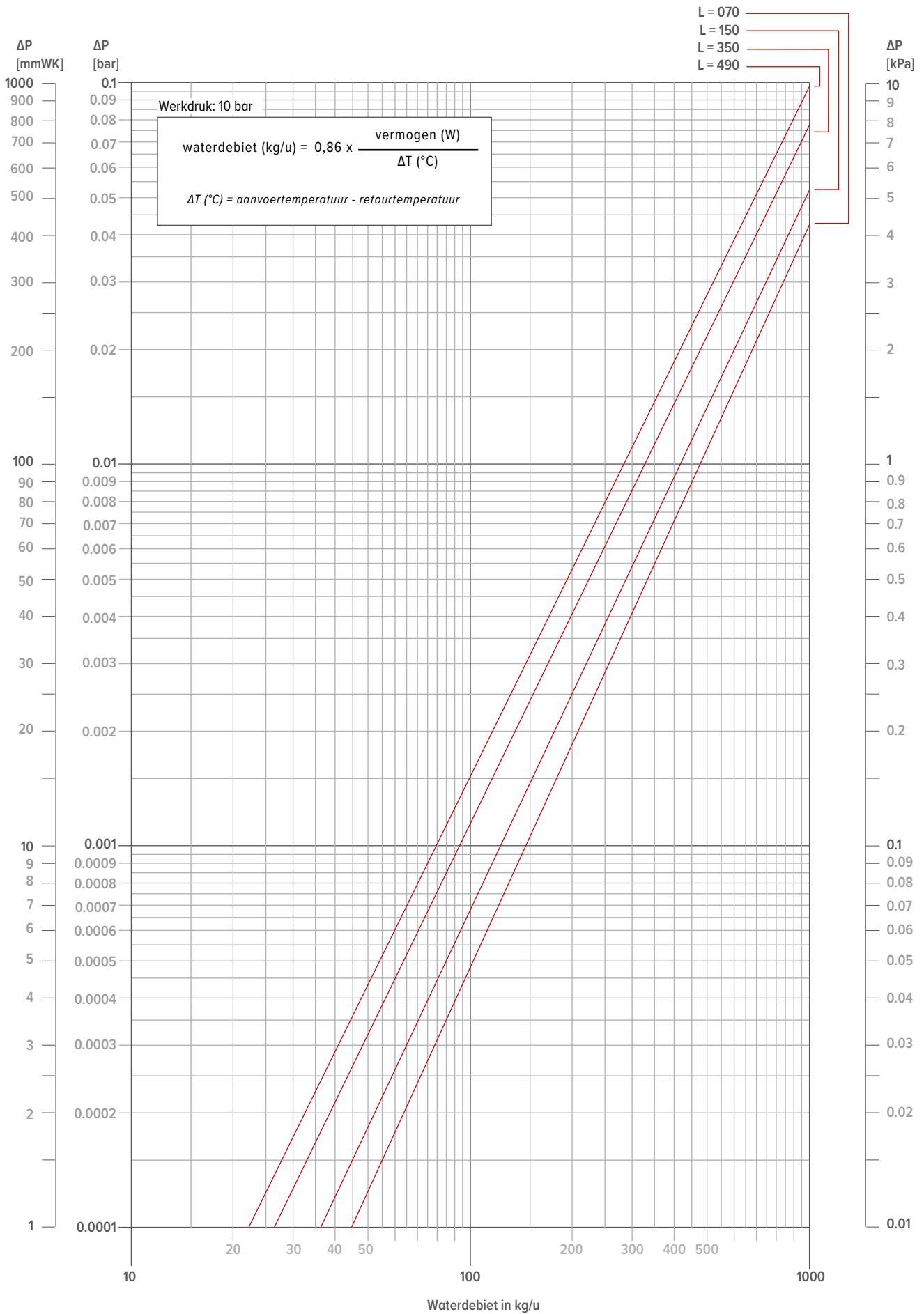

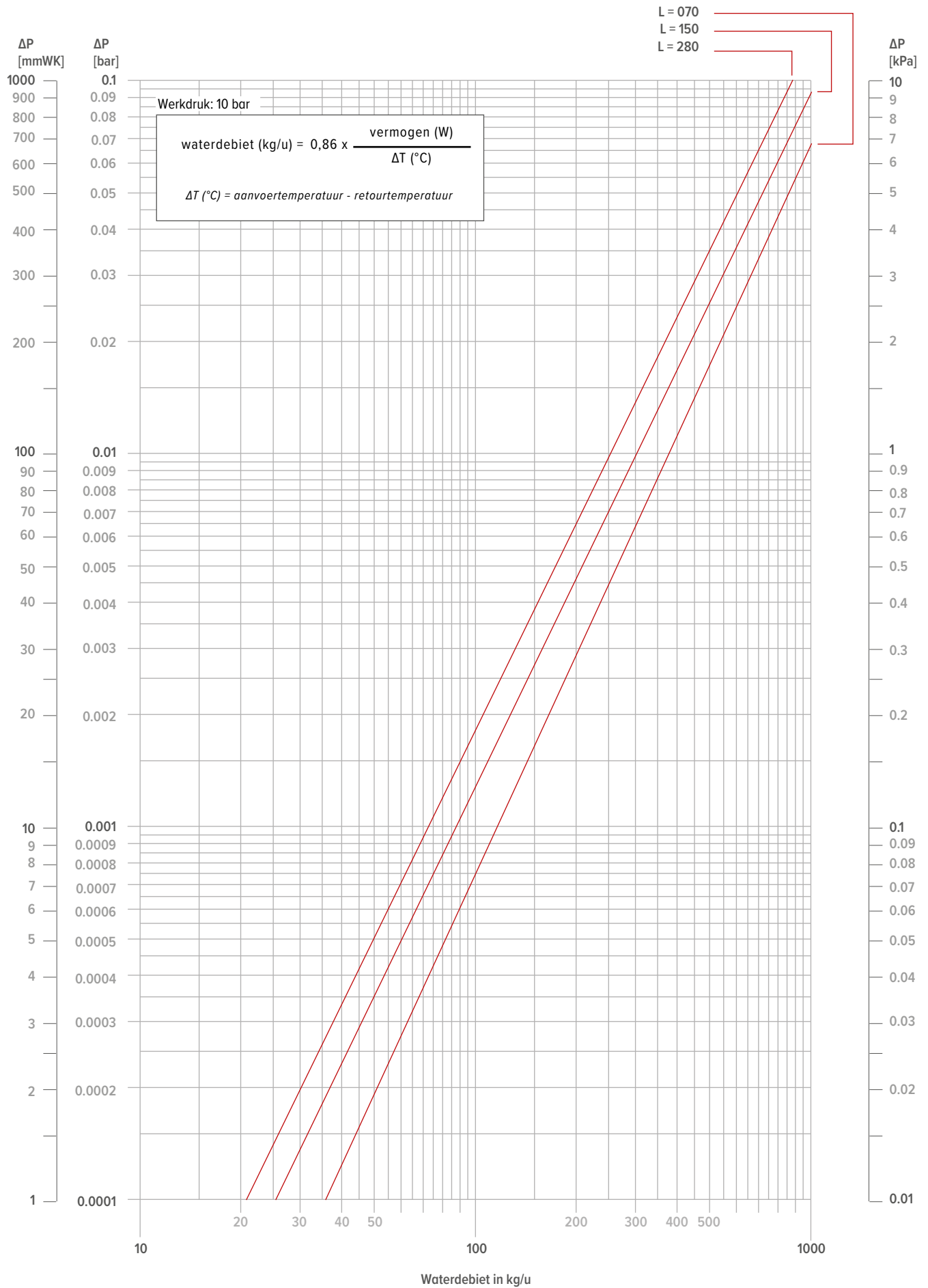

MINI VRIJSTAAND TYPE 14 DUBBELZIJDIG DRUKVERLIES TYPE 14 DUBBELZIJDIG

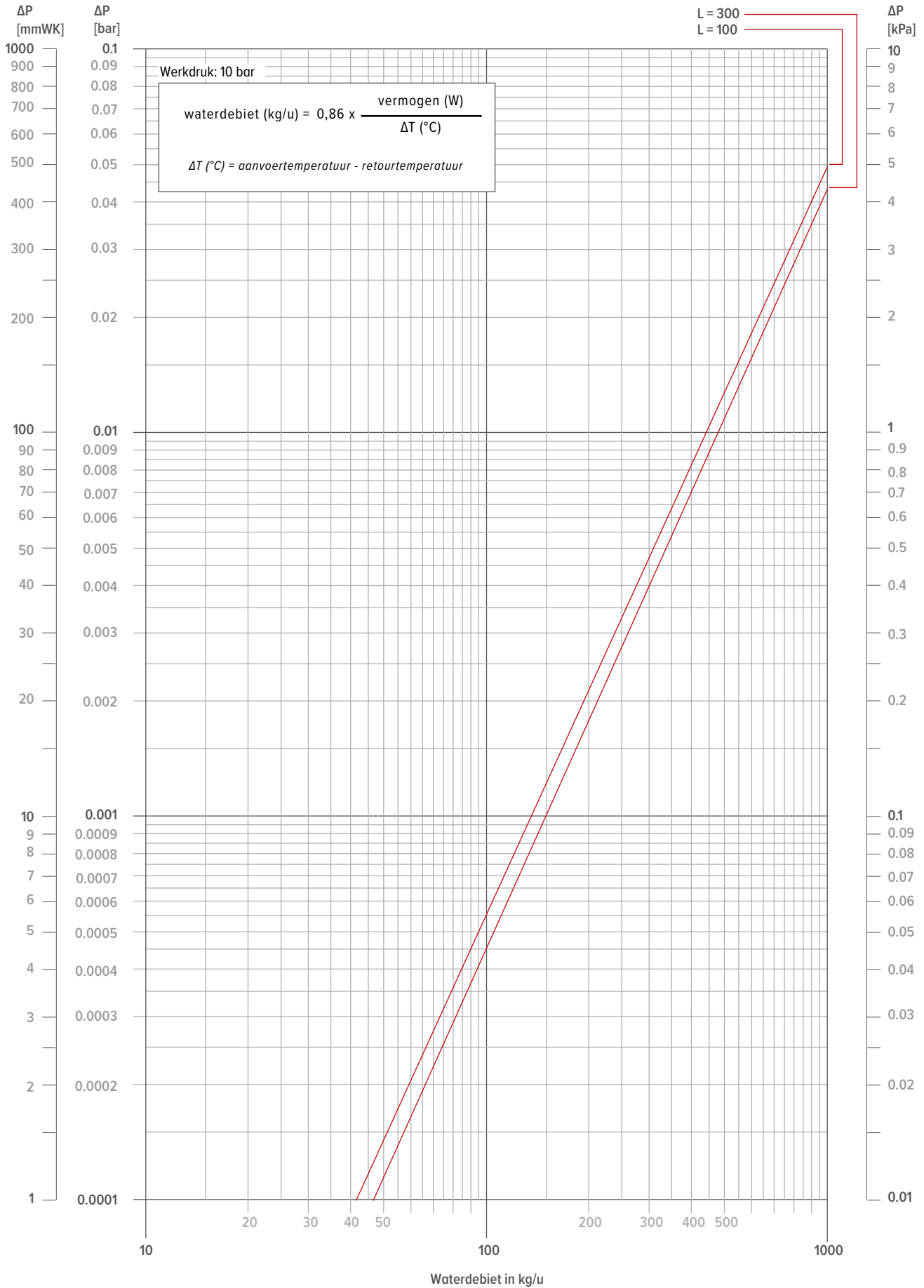

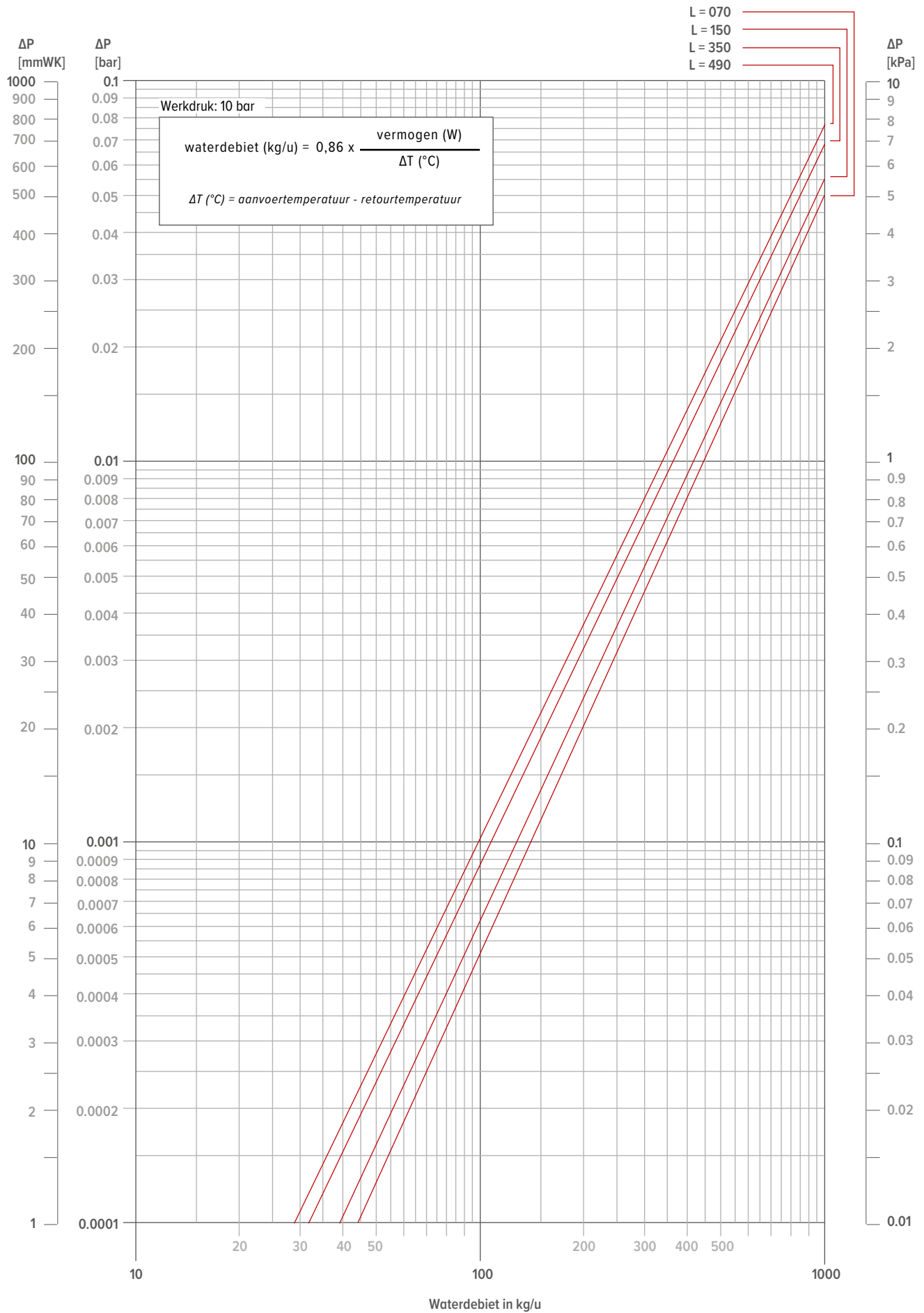

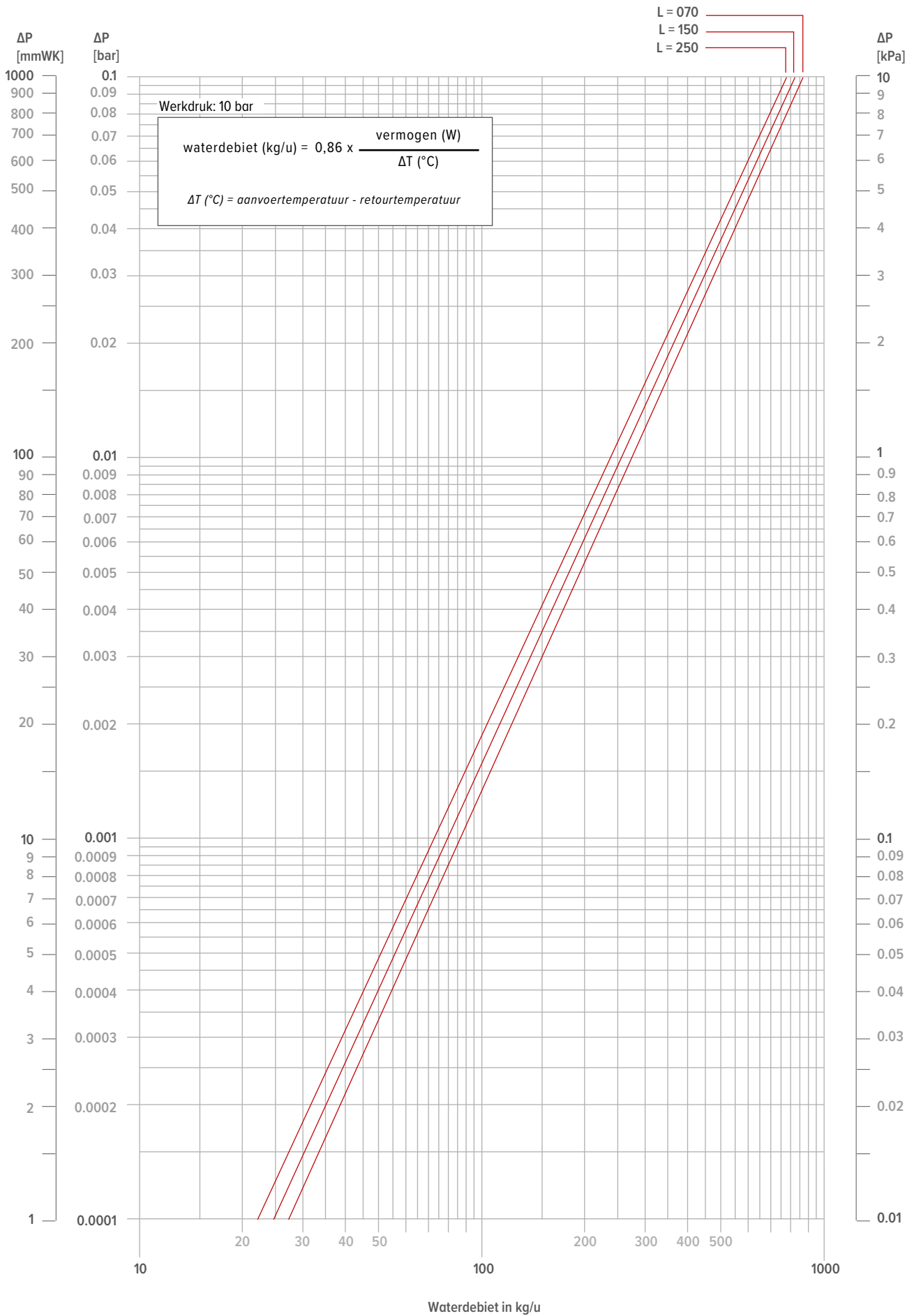

MINI VRIJSTAAND TYPE 19 DUBBELZIJDIG DRUKVERLIES TYPE 19 DUBBELZIJDIG

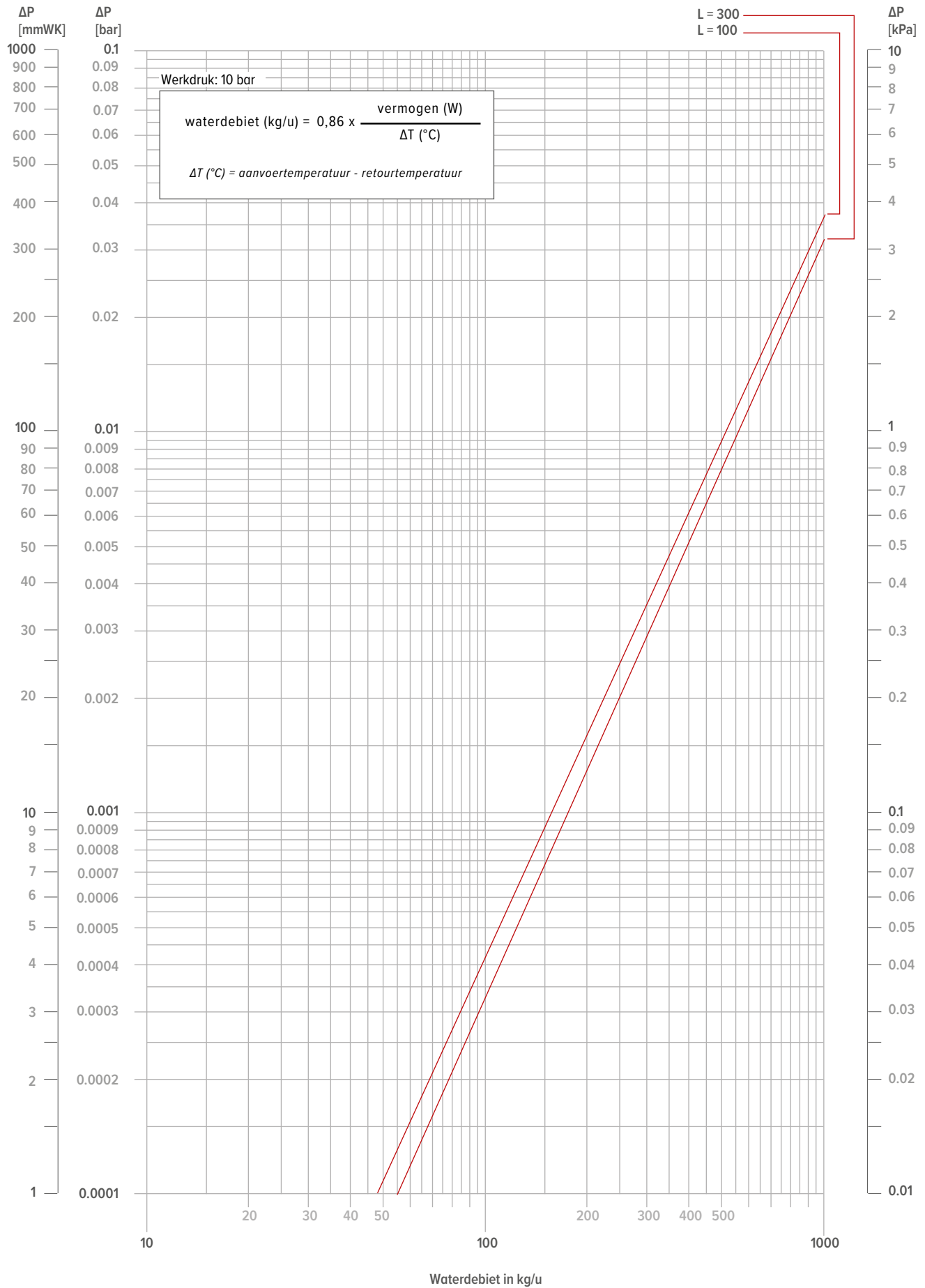

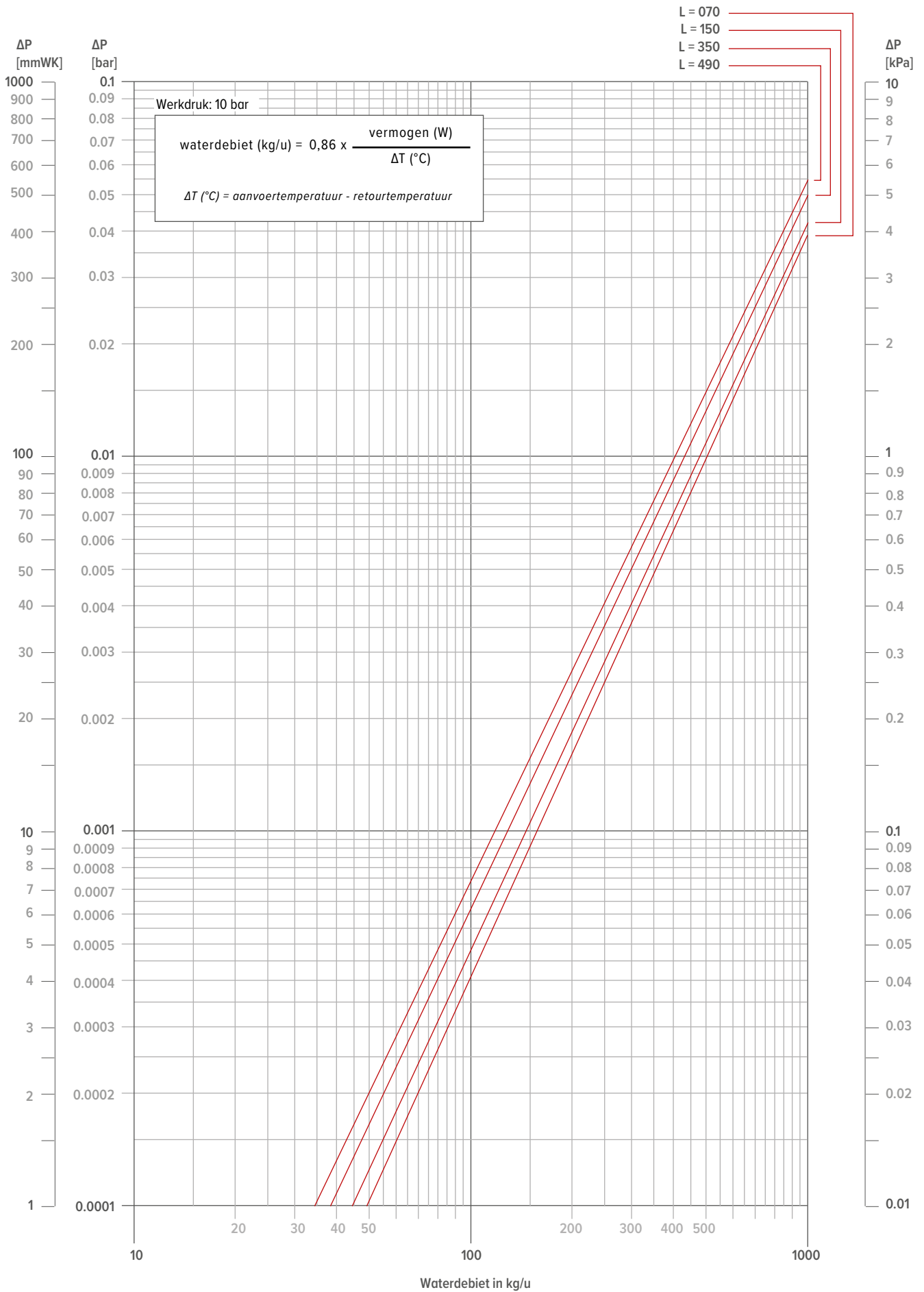

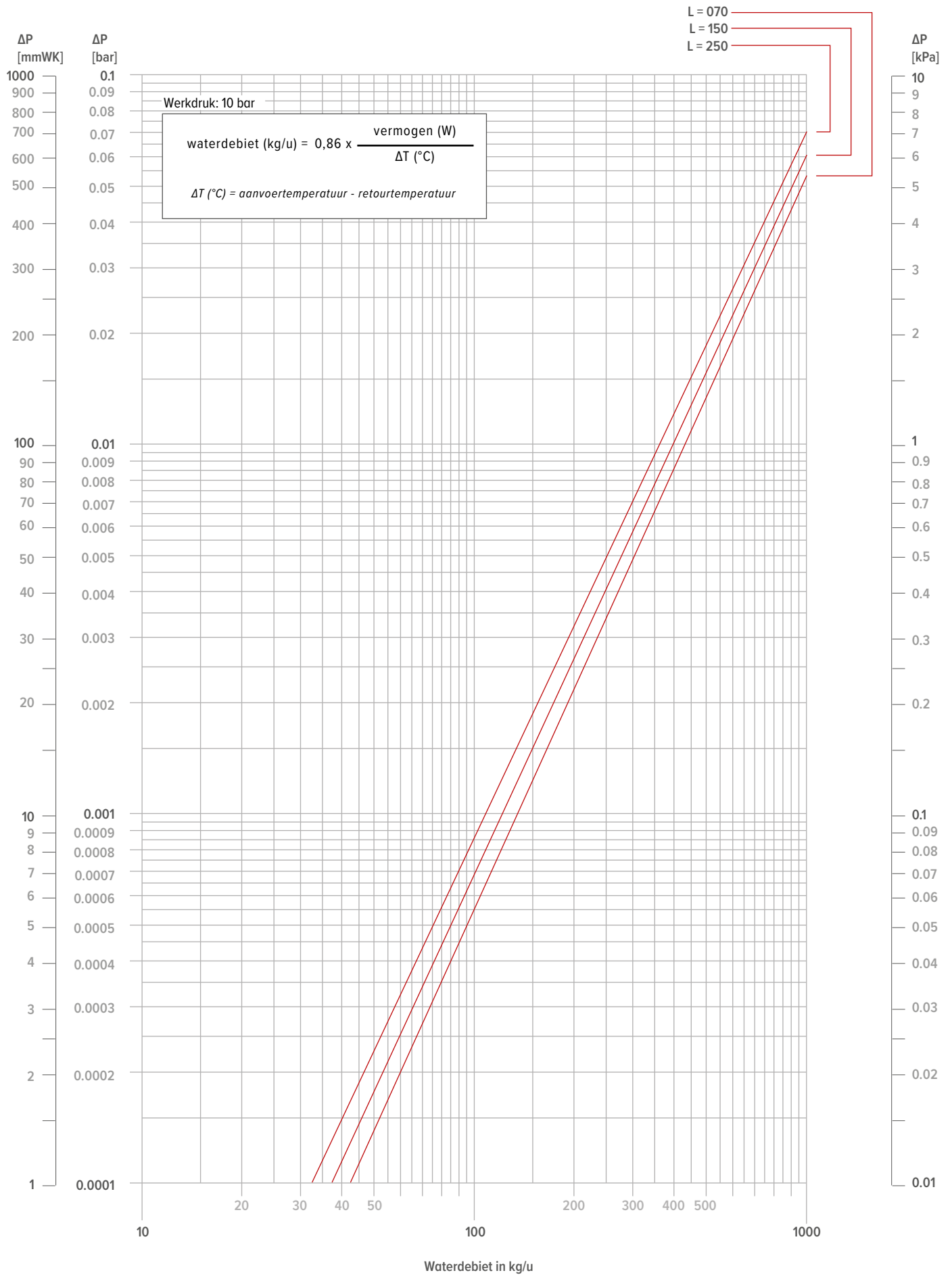



jaga CLIMATE
DESIGNERS

NEDERLAND KONVEKTCO NEDERLAND BV

Persoonlijk advies? Maak een afspraak in het Jaga adviescentrum in
's-Hertogenbosch!

+31 (0)73 631 23 60

info@jaga.nl
www.jaga.nl

BELGIË JAGA NV

Verbindingslaan 16
3590 Diepenbeek

+32 (0) 11 29 41 11

info@jaga.be
jaga.com