

- \* Het is mogelijk de Heatwave over een bereik van 360° te monteren.
- De positie van de Heatwave in deze handleiding geniet de voorkeur van de ontwerper.
- \* Il est possible de monter le Heatwave sur une portée de 360°.
- La position du Heatwave décrite dans ce manuel a la préférence du concepteur.
- \* Der Heatwave lässt sich im 360° Bereich montieren.
- Die Position des Heatwave wird im Hinweis als die bevorzugte Position des Entwickler gezeigt.
- \* It is possible to fix the Heatwave over a range of 360°.
- The position of the Heatwave shown in the manual is the position preferred by the designer.

**opmerking - remarque - Anmerkung - remark**

Daar de Heatwave een artisaan product is kunnen er kleine kleur- of maatafwijkingen voorkomen. Deze kleurafwijking stabiliseert zich na het uitharden van de gebruikte materialen.

Dans la mesure où le Heatwave est un produit artisanal, des petites différences de couleurs ou de dimensions sont possibles. Cette différence de couleur se stabilise après le durcissement des matériaux utilisés.

Da der Heatwave ein handgemachtes Produkt ist, können kleine Farb- oder Maßabweichungen vorkommen. Diese Farbabweichungen geben sich mit der Zeit, sie passen sich durch die Nutzung an.

The Heatwave is a hand-crafted product. Hence, minor colour or dimensional variations can sometimes be evident. After initial curing, minor colour variations will tend to even out over the surface of the material.

**Onderdelen - Parts - Teile**

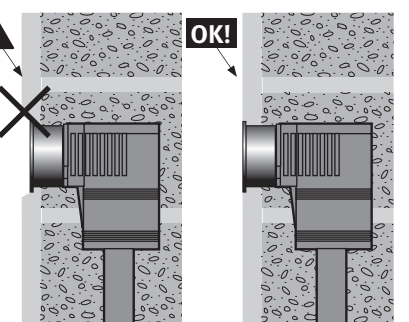
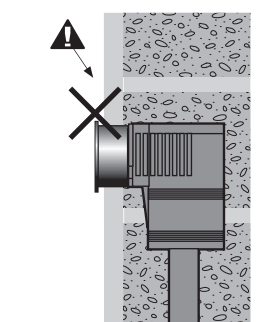
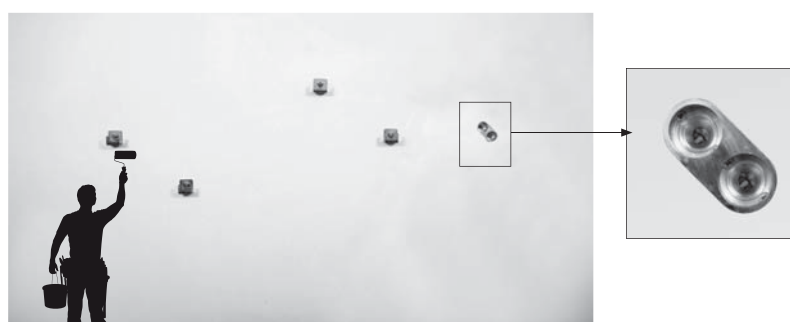
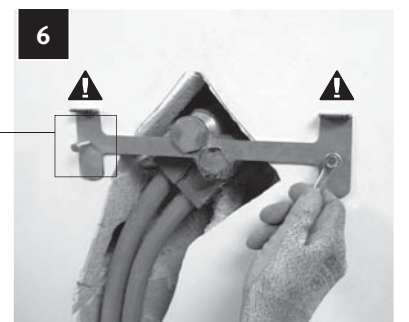
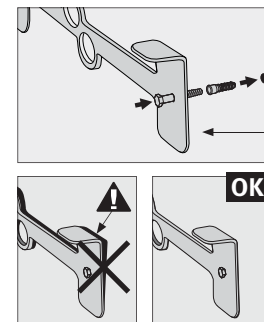
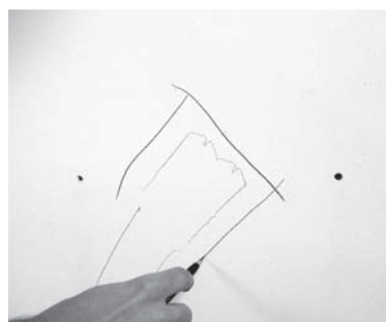
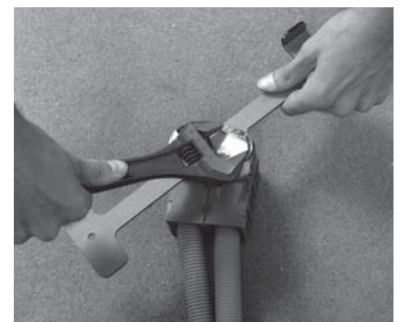
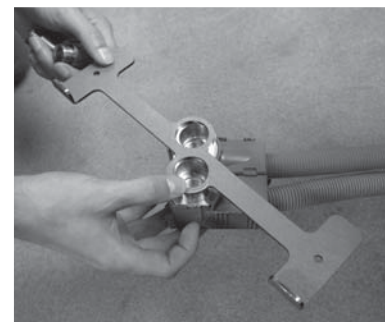
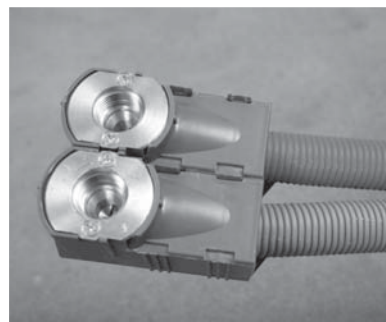
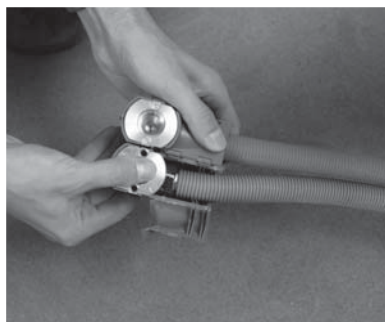
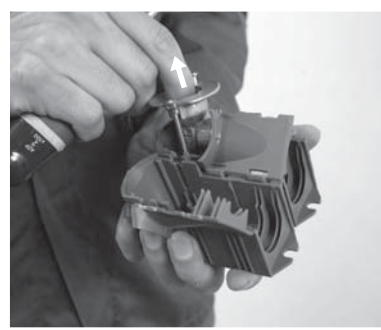
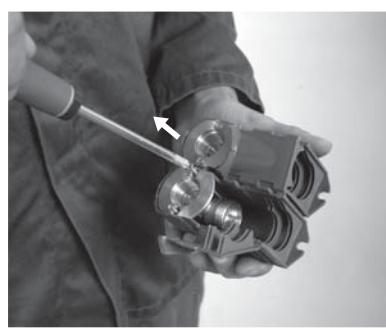
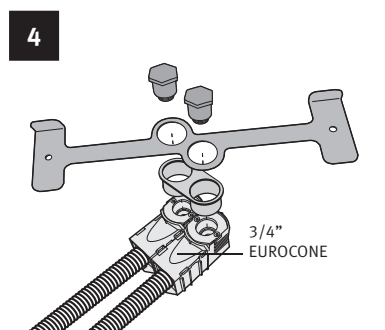
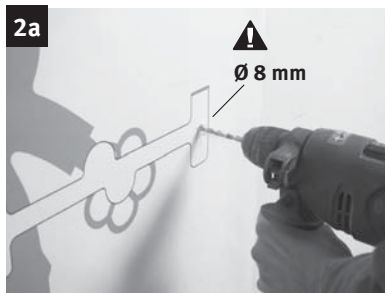
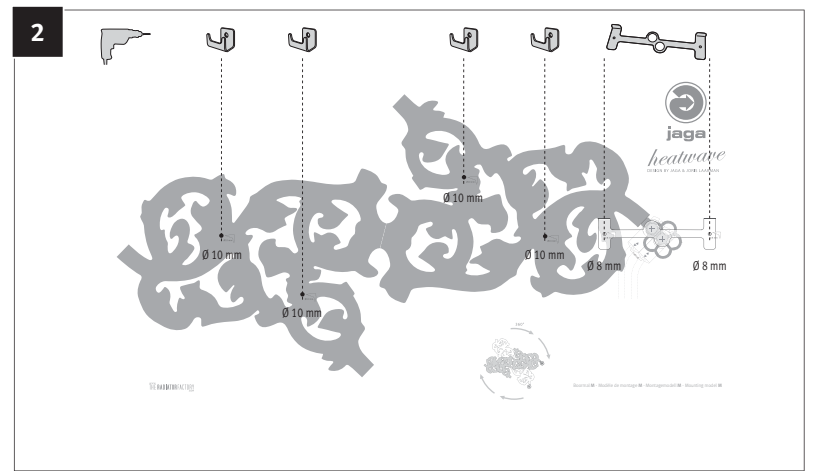
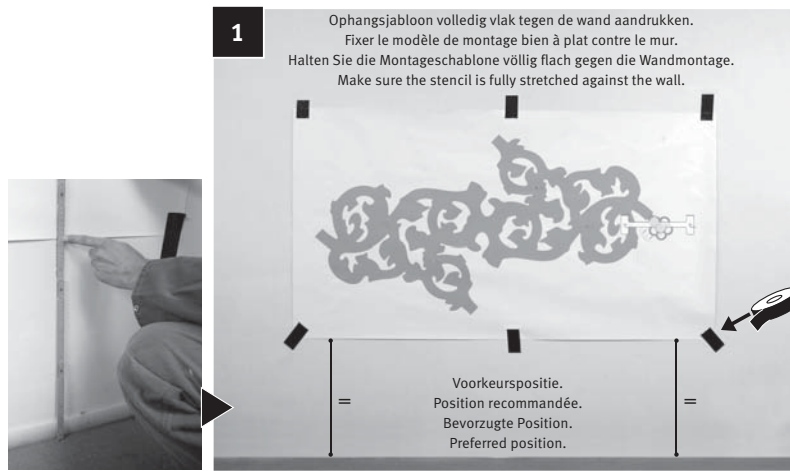
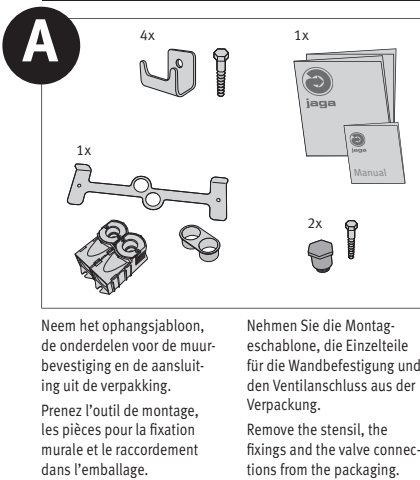
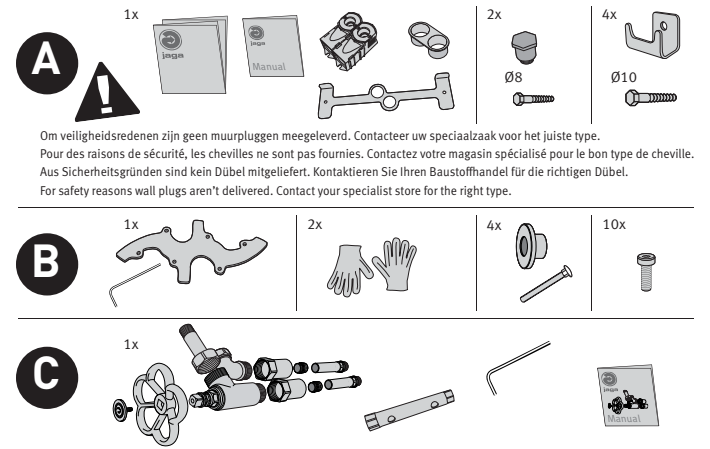



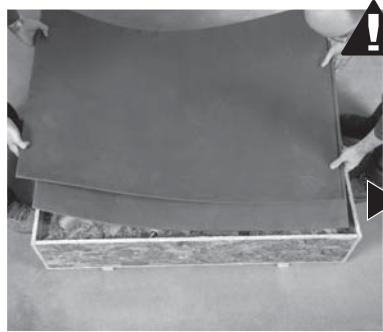
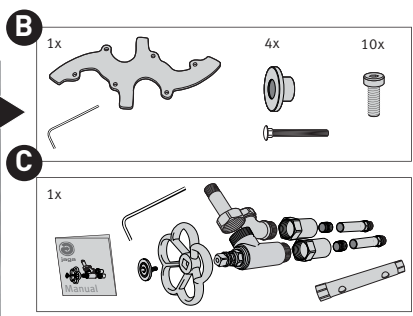
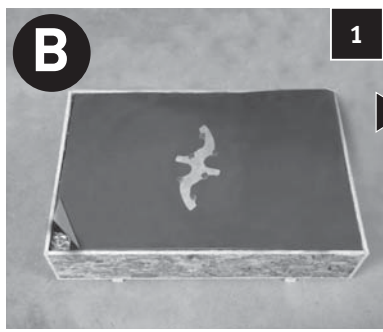

Gebruik het schuimrubber als bescherming op de vloer tijdens de montage van de Heatwave.  
 Utilisez la mousse de caoutchouc comme protection sur le sol pendant le montage du Heatwave.  
 Benutzen Sie den Schaumgummi als Fußbodenschutz, wenn Sie den Heatwave montieren.  
 A foam rubber mat is supplied for protection of the Heatwave during assembly. Please place this on the floor and assemble the radiator on it before mounting.

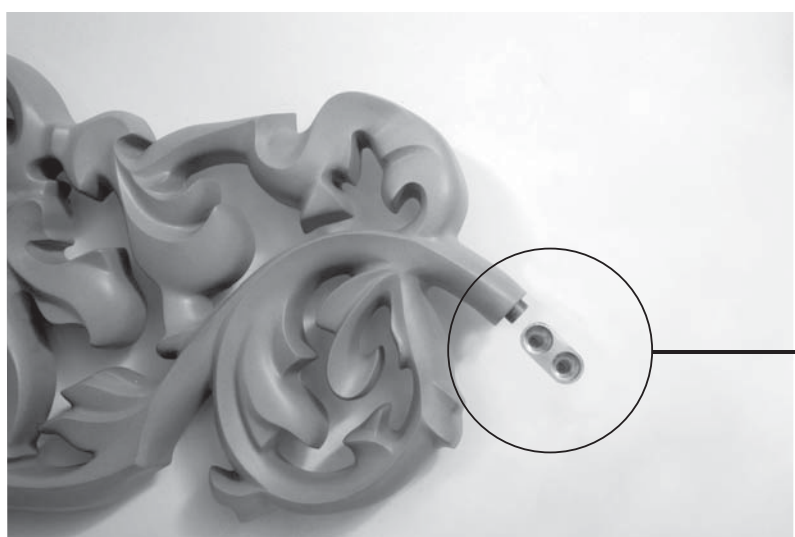
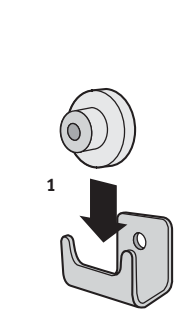
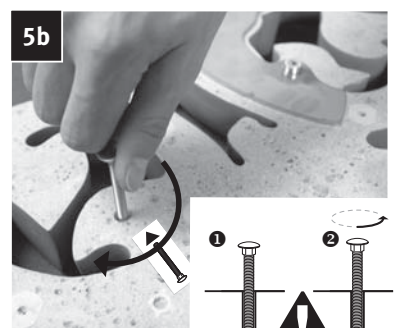
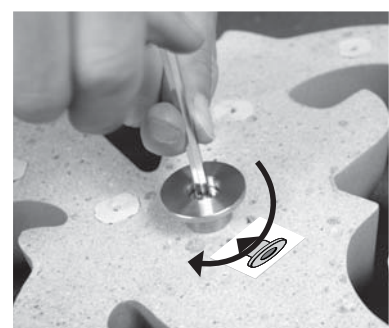
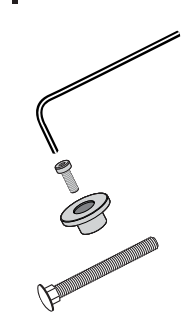
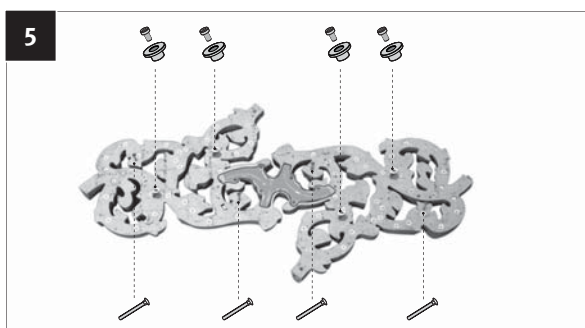
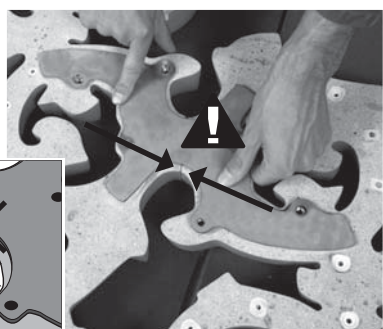
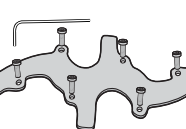
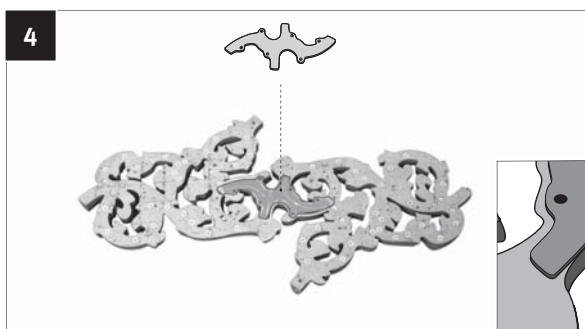
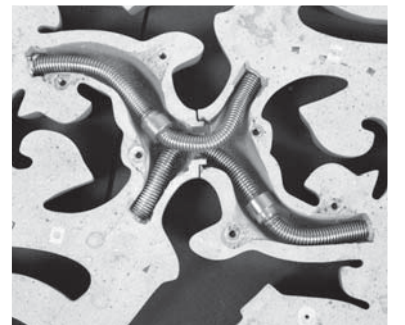
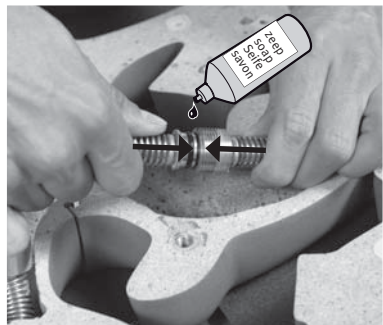
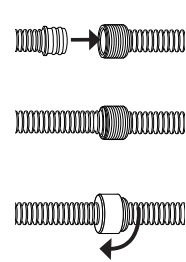
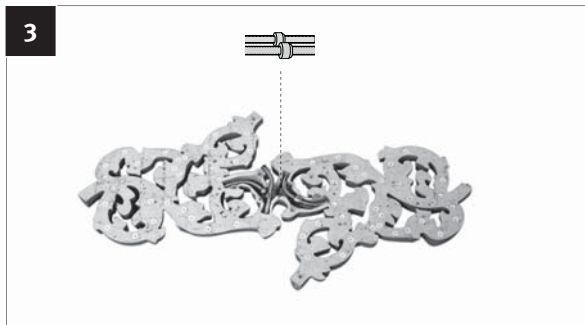
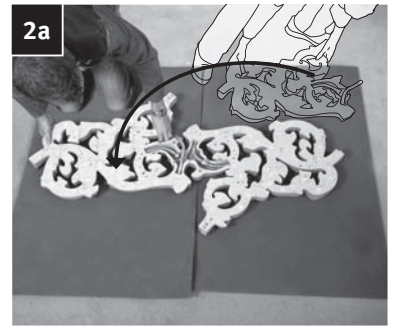
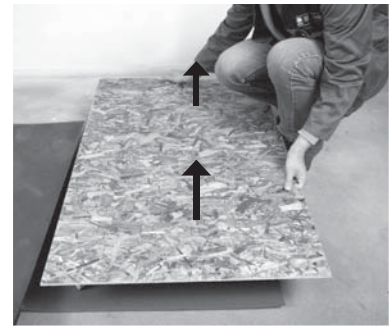
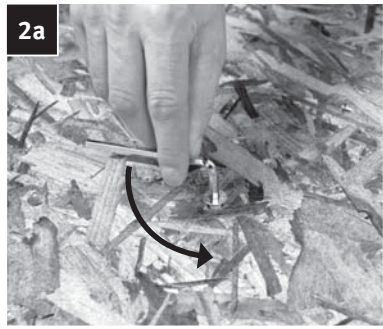
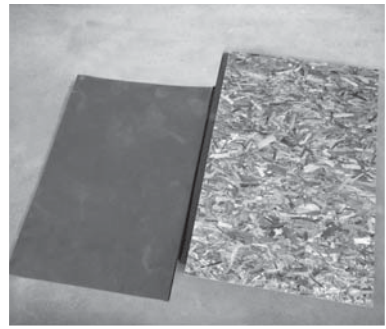
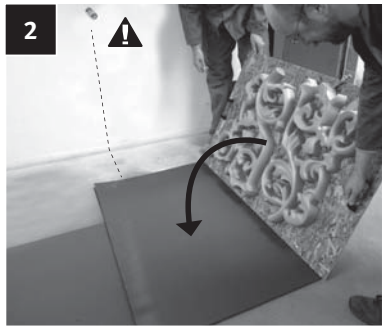

aansluiting - raccordement  
 Anschluß - connection

