



JAGA M24 _ Kv max. 0.32

Energy SAVERS LOW-H2O

Montagehandleiding Jaga M24 ventiel - kleine Kv _ Aansluiting naar de wand
 Instructions de montage vanne Jaga M24 - Kv réduit _ Raccordement vers le mur
 Montagehinweis Jaga M24 Ventil - kleiner Kv _ Anschluss zur Wand
 Mounting instructions Jaga M24 valve - reduced Kv _ Connection to the wall

Afmetingen Dimensions Abmessungen Dimensions

Code / Art.-Nr.

5090.406

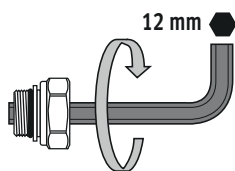
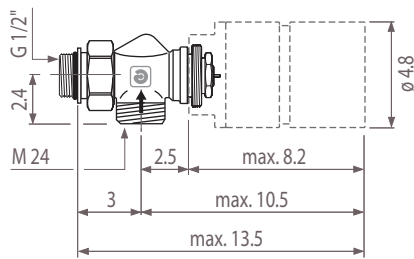

Opties / Options / Optionen

Thermostaatkop Tête de vanne thermostatique Thermostatkopf Thermostatic head

Code / Art.-Nr.

5090.1125 (Type JW)
 5090.1126 (Type JB)
 5090.1110 (Type DW)
 5090.1111 (Type DC)
 5090.1119 (Type JC)

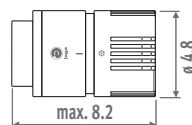

JW (RAL 9016)
 5090.1125
 wit / blanc / weiss / white
JB (RAL 9005)
 5090.1126
 zwart / noir / schwarz / black

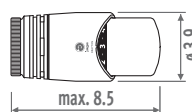

DW
 5090.1110
 chrome - wit / chrome - blanc
 chromiert - weiss / chrome - white
DC
 5090.1111
 chrome / chromiert

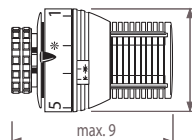

JC
 5090.1119
 zilver / argent / silver / silver

Klemkoppelingen M24 x 1.5 mm Raccords bicônes M24 x 1.5 mm Klemmringverschraubungen M24 x 1.5 mm Sleeve couplings M24 x 1.5 mm

Dunwandig metalen buis
 Tube métallique de précision
 Präzisionsmetallrohr
 Precision metal tube

Code / Art.-Nr.	
5094.110	ø M24 x 10/1
5094.112	ø M24 x 12/1
5094.114	ø M24 x 14/1
5094.115	ø M24 x 15/1
5094.116	ø M24 x 16/1
5094.118	ø M24 x 18/1

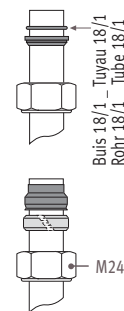

Kunststof buis
 Tuyau synthétique
 Kunststoff Rohr
 Synthetic tube

Code / Art.-Nr.	
5094.213	ø M24 x 12/1
5094.212	ø M24 x 12/2
5094.214	ø M24 x 14/2
5094.219	ø M24 x 16/1.5
5094.216	ø M24 x 16/2
5094.217	ø M24 x 17/2
5094.218	ø M24 x 18/2

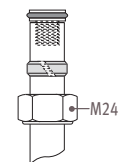

Technische gegevens Données techniques Technische Daten Technical data

› Max. watertemperatuur: 120 °C
 › Max. bedrijfsdruk: 10 bar
 › Max. drukval: 0.6 bar i.v.m. geluidsniveau ref. ISO 3743

› Température max. de l'eau: 120°C
 › Pression de travail max.: 1000 kPa (10 bars)
 › Chute de pression max.: 60 kPa (0.6 bars) par rapport à la norme du niveau sonore réf. ISO 3743.

› Max. Wassertemperatur: 120°C
 › Max. Betriebsdruck: 10 bar
 › Max. Druckgefälle: 0.6 bar in Zusammenhang mit dem Geräuschpegel Ref. ISO 3743

› Maximum water flow temperature: 120 °C
 › Max pressure of system: 10 bar
 › Max pressure drop 0.6 bar complying to the noise standard ISO 3743

Retourventiel M24 90° Raccord de réglage M24 90° Rücklaufverschraubung M24 90° Lockshiekd M24 90°

Code / Art.-Nr.

5090.111

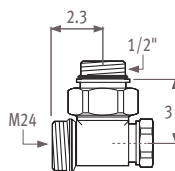

Retourventiel M24 180° Raccord de réglage M24 180° Rücklaufverschraubung M24 180° Lockshiekd M24 180°

Code / Art.-Nr.

5094.431

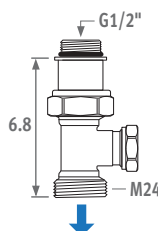

VPE/ALU buis
 Tuyau en PER/ALU
 VPE/ALU Rohr
 RPE/ALU tube

Code / Art.-Nr.	
5094.314	ø M24 x 14/2
5094.316	ø M24 x 16/2
5094.326	ø M24 x 16/2.2
5094.318	ø M24 x 18/2
5094.336	ø M24 x 16/2.2

TECE-buis / tuyau TECE / TECE-Rohr / TECE tube

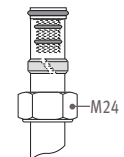

Stalen C.V. buis
 Tuyau en acier
 Eisenrohr
 Steel tube for C.H.

Code / Art.-Nr.	
5094.501	ø M24 x 1/2"
5094.503	ø M24 x 3/8"

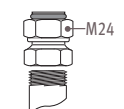

Hydraulische instelling _ Réglage hydraulique _ Hydraulische Einstellung _ Hydraulic adjustment

Voorinstelling _ Préréglage _ Voreinstellung _ Pre-setting:

Kv: m ³ /h/ΔP=1bar	1	2	3	4	5	6	KvS
		0.045	0.065	0.095	0.155	0.220	0.320

Tweepijp _ Bitube _ Zweirohr _ Two pipe

Voorbeeld:

Verwarmingssysteem 1 kW (Tabel ΔT=50)
 ΔT = 10°C (75 - 65 = 10°C)
 ΔP = 0.1 bar (over het ventiel in te stellen)
 Voorinstelling = 6

Beispiel:

Wärmetauscher 1 kW (Tabelle ΔT=50)
 ΔT = 10°C (75 - 65 = 10°C)
 ΔP = 0.1 bar (über das Ventil einzustellen)
 Voreinstellung = 6

Exemple:

Échangeur de chaleur 1 kW (Table ΔT=50)
 ΔT = 10°C (75 - 65 = 10°C)
 ΔP = 0.1 bar (à régler sur la vanne)
 Préréglage = 6

Example:

Heat exchanger 1 kW (Table ΔT=50)
 ΔT = 10°C (75 - 65 = 10°C)
 ΔP = 0.1 bar (to be regulated over the valve)
 Pre-setting = 6

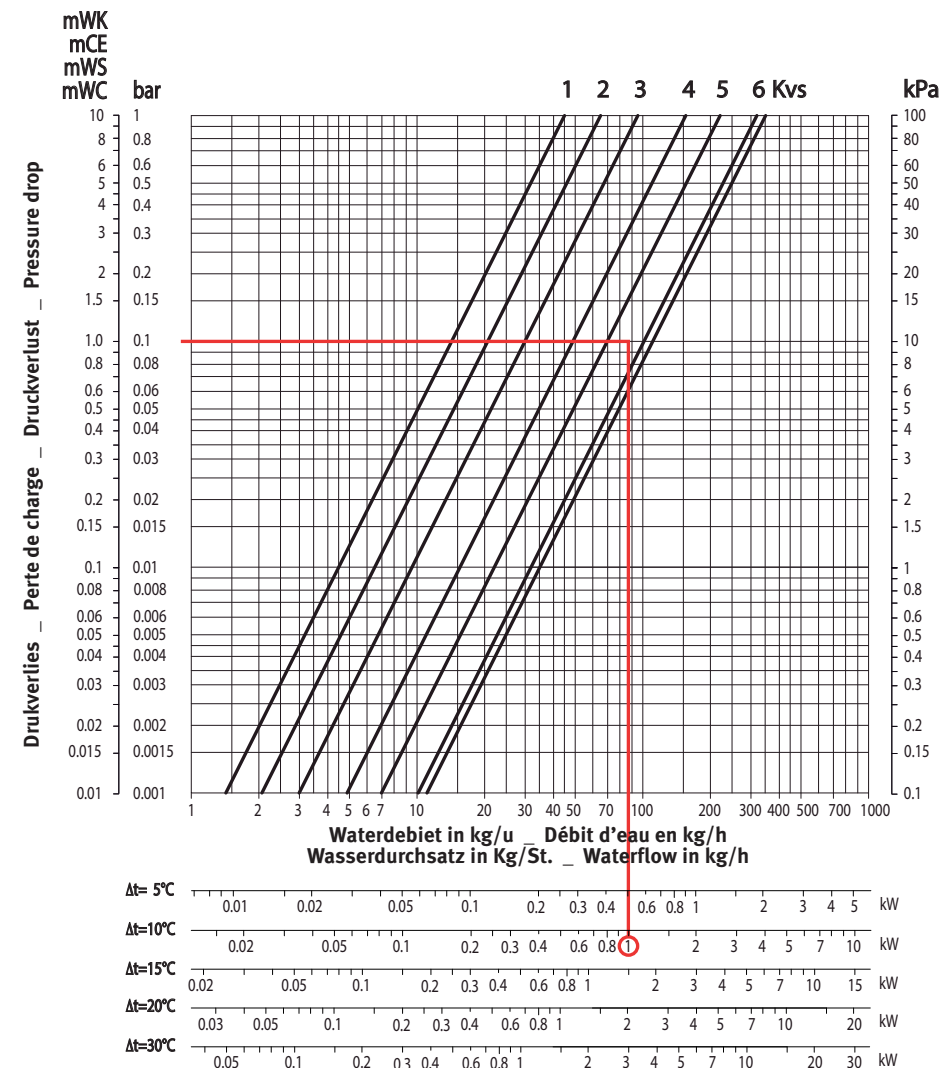

Voorinstelling van het Jaga Type 6 ventiel Préréglage de la vanne Jaga Type 6 Voreinstellung des Jaga Typ 6 Ventils Balancing control of the Jaga type 6 TRV

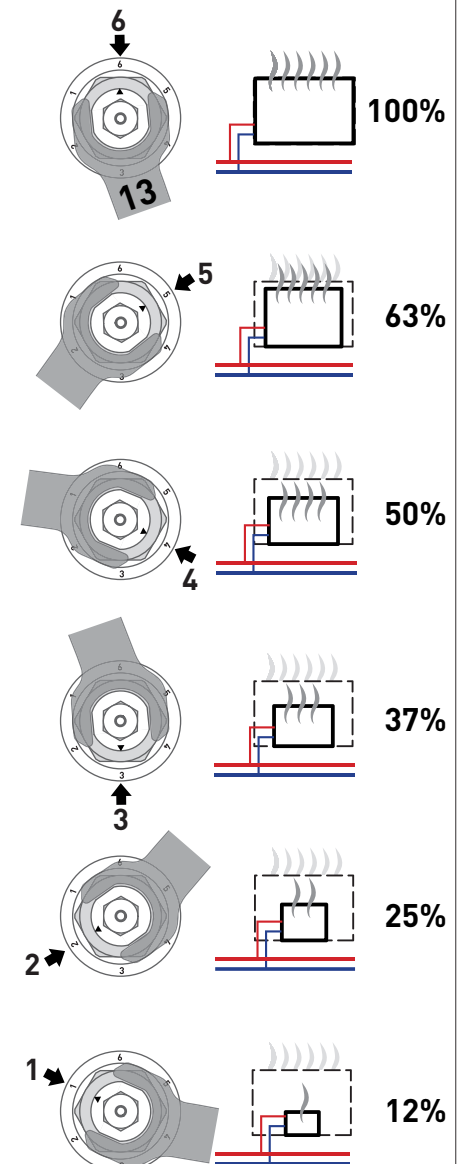
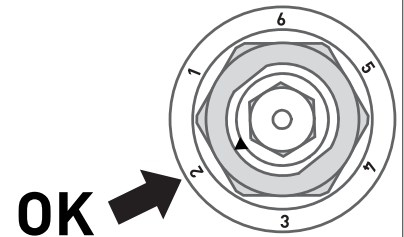
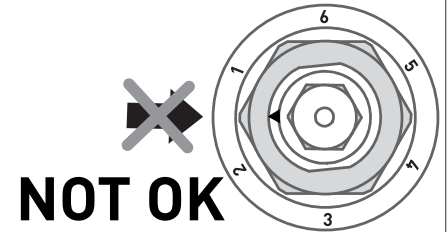

Demontage van de warmtewisselaar Démontage de l'échangeur de chaleur Demontage des Wärmetauschers Unmounting of the heat exchanger

- Sluit de thermostaatkop (1), sluit het retour-ventiel (2), schroef het ventiel en het retourventiel los (3).
- Fermer le thermostatique (1), fermer le raccord de réglage (2), dévisser la vanne et le raccord de réglage (3).
- Thermostatkopf schliessen (1), Rücklaufverschraubung schliessen (2), Ventil und Rücklaufverschraubung losschrauben (3).
- Close the TRV (1), close the lockshield (2), unscrew the valve and the lockshield (3).

