

# jaga

CLIMATE DESIGNERS

Heating 

PLAY TECHNICAL INFORMATION



# PLAY ■ OVERVIEW HEAT EXCHANGERS

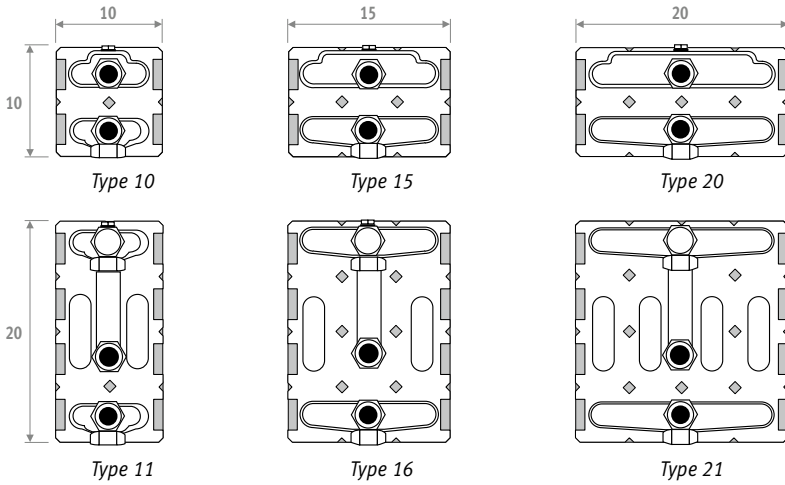

Weight and water content without packaging or options.

PLAY WEIGHT (IN KG/METRE)			
Type	H 35	50	65
10	14.2	16.4	15.3
11	15.6	17.8	16.7
15	16.9	19.4	18.8
16	19.4	21.9	21.3
20	19.7	22.5	22.3
21	22.6	25.4	25.2

WATER CONTENT IN LITRE / METRE	
Type	All heights
10	0.65
11	1.33
15	0.98
16	1.98
20	1.32
21	2.66

PLAY WITH DBE WEIGHT (IN KG/METRE)			
Type	H 35	50	65
10	--	--	--
11	16.6	18.9	17.8
15	--	--	--
16	20.5	23.0	22.4
20	--	--	--
21	23.7	26.5	26.3

# CORRECTION FACTORS STATISCH

The indicated outputs with  $\Delta T$  50 and  $\Delta T$  30 are the exact outputs.  $\Delta T$  50 output measured in accordance with EN442 and  $\Delta T$  30 output calculated according to EN442. An average correction factor is given in this table for all other  $\Delta T$  outputs, applicable for all dimensions.

At [www.jaga.com/downloads/selectiontools](http://www.jaga.com/downloads/selectiontools) you can download the calculation tools with the exact outputs. The online calculation tools are kept up to date with the most recent data. Minor output differences between printed tables and the different online calculation tools are therefore completely normal and within the margins of tolerance imposed by the standard.

## AVERAGE CORRECTION FACTORS FOR STATIC PRODUCTS ACCORDING TO EN442

Room temperature: 20°C										Room temperature: 24°C											
Average N-value: 1.36										Average N-value: 1.36											
Ta	Tr	65	60	55	50	45	40	35	30	25	Ta	Tr	65	60	55	50	45	40	35	30	25
75		1.00	0.93	0.85	0.77	0.69	0.61	0.52	0.42	0.31	75		0.89	0.82	0.75	0.67	0.59	0.51	0.41	0.31	0.16
70		0.94	0.87	0.79	0.72	0.64	0.56	0.48	0.39	0.28	70		0.83	0.76	0.69	0.62	0.54	0.47	0.38	0.28	0.14
65			0.80	0.74	0.67	0.60	0.52	0.44	0.35	0.25	65			0.70	0.64	0.57	0.50	0.43	0.35	0.25	0.12
60				0.68	0.61	0.55	0.48	0.40	0.32	0.23	60				0.58	0.52	0.45	0.38	0.31	0.23	0.11
55					0.56	0.50	0.43	0.36	0.29	0.20	55					0.47	0.41	0.34	0.28	0.20	0.09
50						0.44	0.38	0.32	0.25	0.18	50						0.36	0.30	0.24	0.17	0.08
45							0.34	0.28	0.22	0.15	45							0.26	0.20	0.14	0.06
40								0.24	0.19	0.13	40								0.17	0.12	0.05
35									0.15	0.10	35									0.09	0.03
30										0.07	30										0.02

## RECOMMENDED MAXIMUM WATER FLOW DEPENDING ON THE PIPE DIAMETER AT A MAX. WATER FLOW OF 0.4 M / S

Tube	Outer Ø mm	Wall thickness mm	Maximum flow kg/h	Maximum power at $\Delta T$ (° C) (T supply - T return))				
				$\Delta T$ 2	$\Delta T$ 5	$\Delta T$ 10	$\Delta T$ 20	$\Delta T$ 30
				Watt	Watt	Watt	Watt	Watt
10/1	10.0	1.0	72	168	421	841	1682	2524
12/1	12.0	1.0	113	263	657	1314	2629	3943
12/2	12.0	2.0	72	168	421	841	1682	2524
14/1	14.0	1.0	163	379	946	1893	3785	5678
14/2	14.0	2.0	113	263	657	1314	2629	3943
15/1	15.0	1.0	191	444	1111	2221	4443	6664
16/1	16.0	1.0	222	515	1288	2576	5152	7729
16/1.5	16.0	1.5	191	444	1111	2221	4443	6664
16/2	16.0	2.0	163	379	946	1893	3785	5678
16/2.2	16.0	2.2	152	354	884	1769	3537	5306
17/2	17.0	2.0	191	444	1111	2221	4443	6664
3/8"	17.1	3.2	129	301	752	1505	3010	4515
18/1	18.0	1.0	289	673	1682	3365	6730	10095
18/2	18.0	2.0	222	515	1288	2576	5152	7729
20/2	20.0	2.0	289	673	1682	3365	6730	10095
1/2"	21.3	3.7	217	504	1259	2518	5035	7553
26/3	26.0	3.0	452	1052	2629	5258	10515	15773

# PLAY - PRESSURE DROP

## PRESSURE DROP TYPE 10

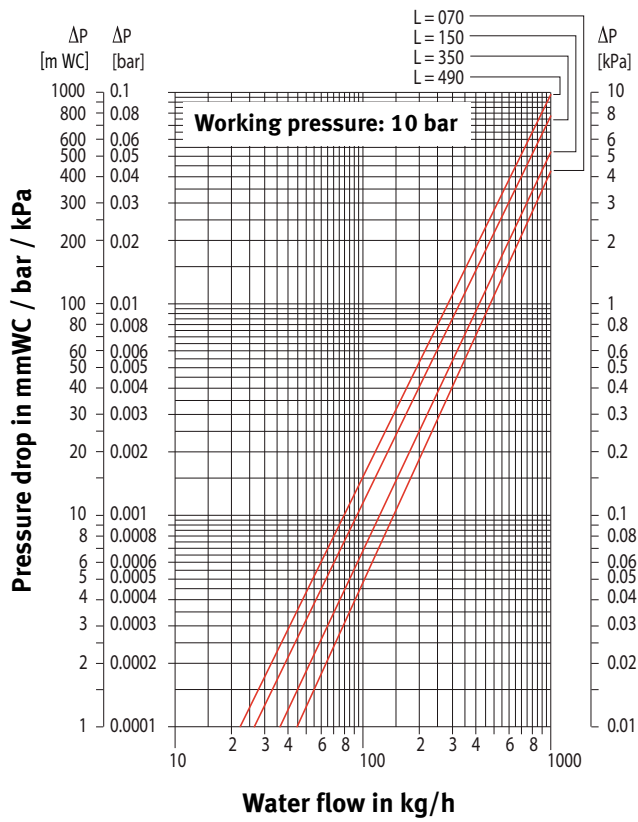

## PRESSURE DROP TYPE 11

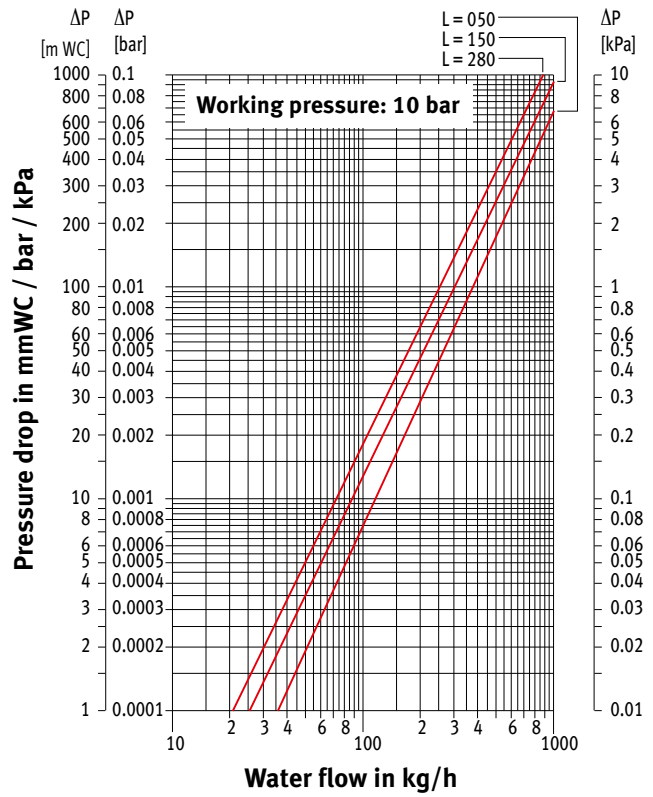

## PRESSURE DROP TYPE 15

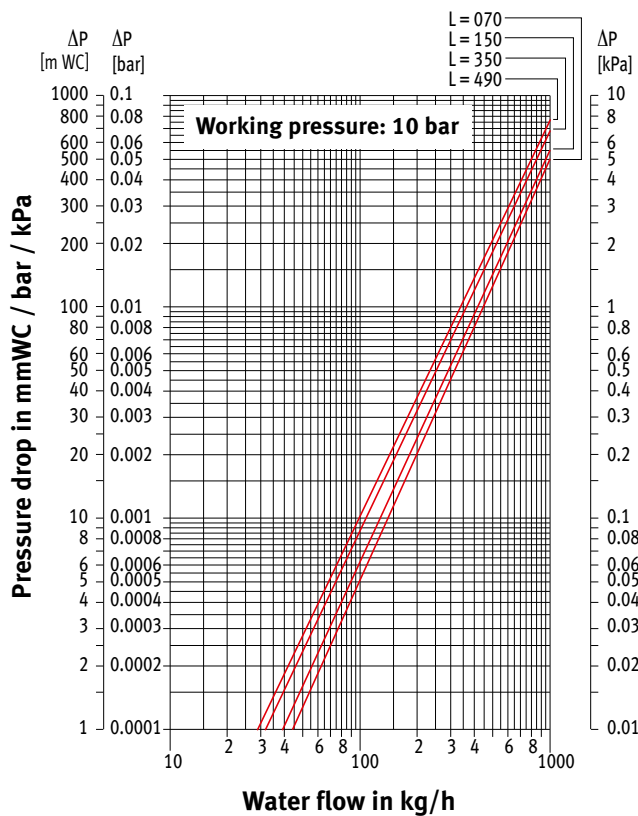

## PRESSURE DROP TYPE 16

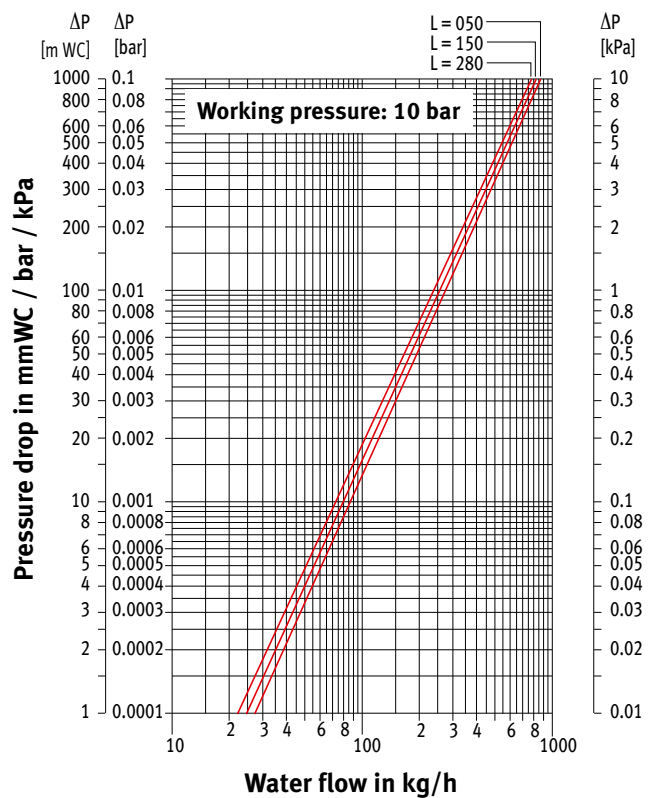

## PRESSURE DROP TYPE 20

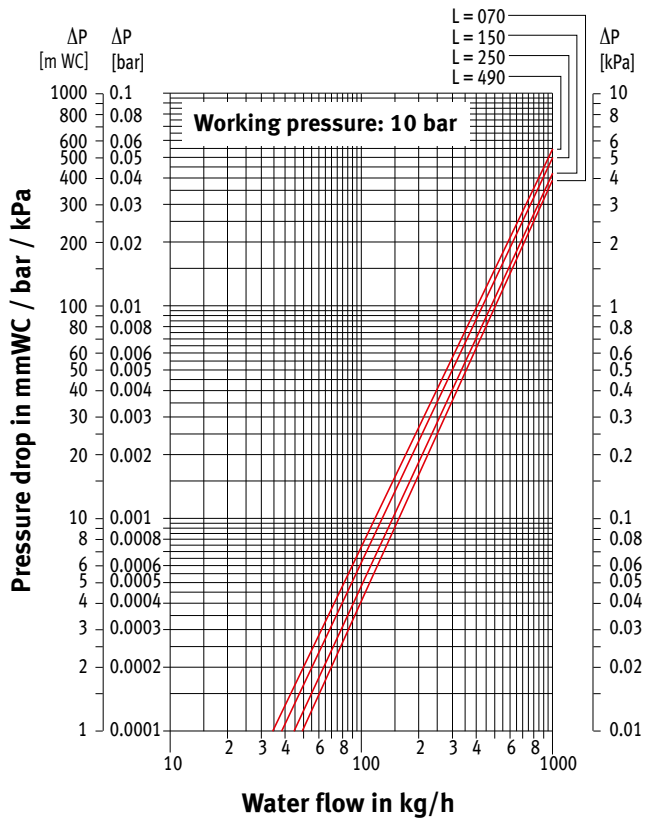

## PRESSURE DROP TYPE 21

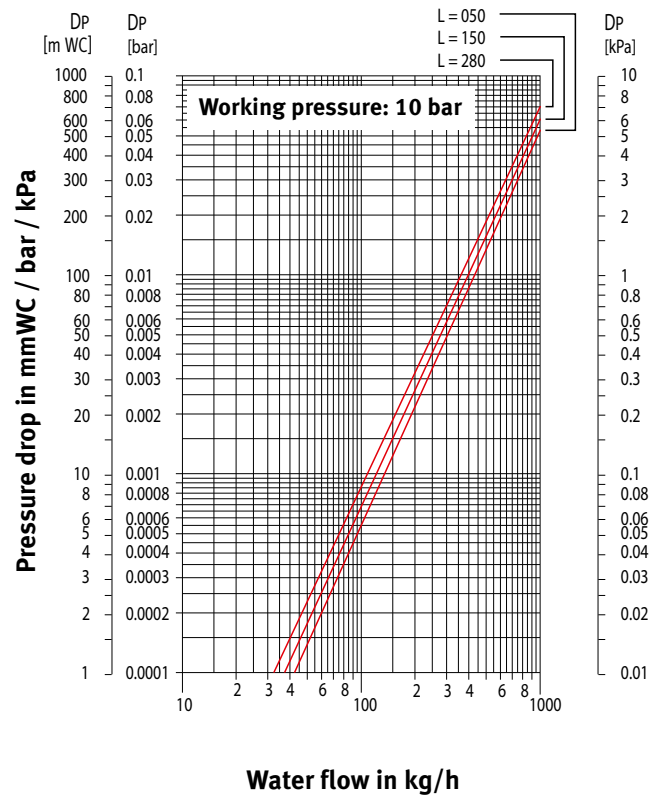

**jaga**  
CLIMATE  
DESIGNERS

Jaga International  
Verbindingslaan 16  
B-3590 Diepenbeek

Tel.: +32 (0)11 29 41 12  
Fax: +32 (0)11 29 41 60  
export@jaga.com

The information in this price list is correct at the time of printing.  
Jaga reserves the right to change product specification at any time in line  
with our policy of continuous improvement and innovation.  
All prices in Euro, exclude VAT. Prices valid from February 1, 2021.  
Replaces all existing price lists.