

# jaga

CLIMATE DESIGNERS



## STRADA



INFO@JAGA.BE 011 29 41 11

## STRADA HYBRID

Vous voulez plus de rendement à basse température, et/ou vous voulez du Light Cooling avec un Strada ? Optez alors pour Strada Hybrid.



## STRADA HYBRID MM

Vous voulez plus de rendement à basses températures, et/ou vous voulez du Light Cooling avec un Strada doté d'une connexion centrale ? Optez alors pour Strada Hybrid MM.



## DBH UPGRADE SET

Vous avez déjà un Strada, et vous souhaitez le mettre à niveau pour plus de rendement à basse température, et/ou vous voulez du Light Cooling ? Jetez alors un coup d'œil à la brochure du DBH Upgrade Set.

### AVANT

Seulement pour chauffer 

Strada H50 L100 Type 11



### APRÈS

Chauffer 

+

Breeze 

+

Refroidir 

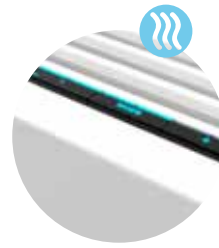
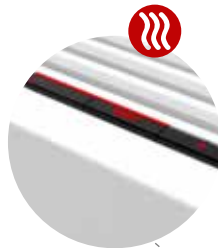

Light cooling avec toutes les pompes à chaleur dotées d'une fonction refroidissement.

Strada H50 L100 Type 11  
+ Kit DBH type 10

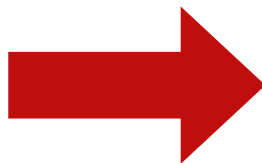

Unités de ventilateurs à clipser

# STRADA

<b>TABLE DES MATIÈRES</b>	<b>3</b>
<b>DONNÉES TECHNIQUES</b>	<b>5</b>
<b>Dimensions</b>	<b>5</b>
<b>Option porte-serviette</b>	<b>5</b>
<b>Raccordement hydronique</b>	<b>6</b>
Connexion à gauche ou à droite Avec commande en bas (Standard)	6
Connexion à gauche ou à droite avec commande au-dessus	6
Connexion à gauche ou à droite avec commande à distance	6
<b>Les raccords les plus utilisés</b>	<b>7</b>
<b>Tableau technique</b>	<b>8</b>
Hauteur 020	8
Hauteur 035	10
Hauteur 050	12
Hauteur 065	14
Hauteur 095	16
<b>Pièces détachées</b>	<b>18</b>
<b>Coefficients de correction</b>	<b>20</b>
<b>Pertes de charge</b>	<b>21</b>
Type 06	21
Type 10	22
Type 11	23
Type 15	24
Type 16	25
Type 20	26
Type 21	27



## DIMENSIONS (en mm)

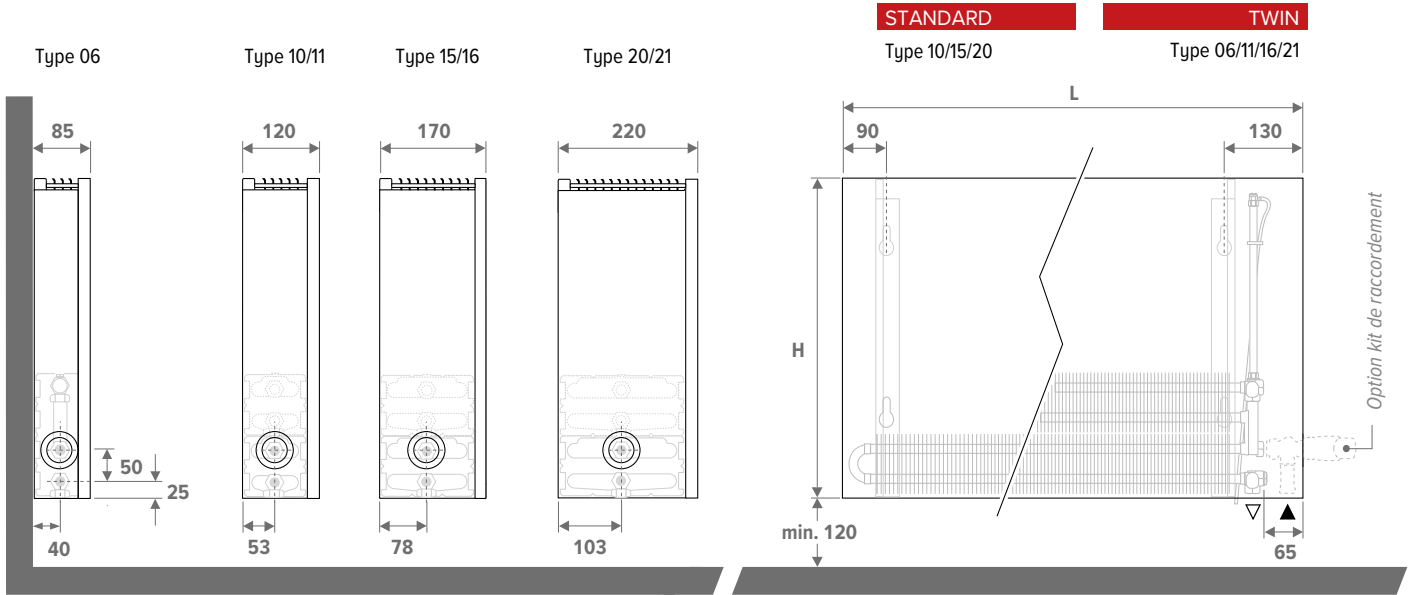

### LIVRAISON STANDARD

- échangeur de chaleur Low-H<sub>2</sub>O, avec revêtement anti-salissures et anti-poussière gris graphite (RAL 7024)
- consoles murales, set de fixation, purgeur incliné (hauteur 020) ou purgeur allongé 1/8" et bouchon de vidange 1/2"
- habillage partiellement prémonté pour raccordement en bas à gauche ou à droite
- plaque de recouvrement en look acier inoxydable pour le côté latéral de raccordement non utilisé

### COULEURS

Peinture écologique avec habillage en poudre anti-rayure et haute résistance UV

#### Couleurs standards

- couleur blanc signalisation RAL 9016 (133), laque soft touch, aspect satin, finement structurée
- gris sablé (001), laque métallique fine structure
- off-black (145), laque satinée soft touch légèrement structurée

#### Autres couleurs

voir carte de couleurs Jaga.  
 Supplément de prix en fonction de la longueur de l'appareil :

- Longueur < 100 cm
- Longueur de 100 cm à 200 cm
- Longueur > 200 cm

### PORTE-SERVIETTE

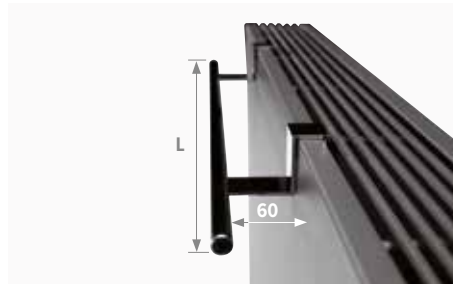

CODE	L	
5501 001	560	en aluminium chromé
5501 002	660	en aluminium chromé

### CODE DE COMMANDE

STRW 020 050 06 XXX  
 Couleur  
 Type  
 Longueur  
 Hauteur



## STANDARD: CONNEXION À GAUCHE OU À DROITE AVEC COMMANDE EN BAS

Gauche ou droite vers le bas, vers le mur ou vers le sol. Raccordement mural par la face inférieure de l'habillage ou complètement invisible dans l'habillage.

L'installateur peut faire pivoter l'échangeur de chaleur pour une connexion à droite ou à gauche.

Jeux de raccords Eurocône possibles.: 101, 102, 103, 104, 181, 182, 183, 184, 222, 225, 226, 282, 285

Jeux de raccords M24 possibles: 11, 12, 13, 14, 25

### Exemple de raccord à droite (standard)

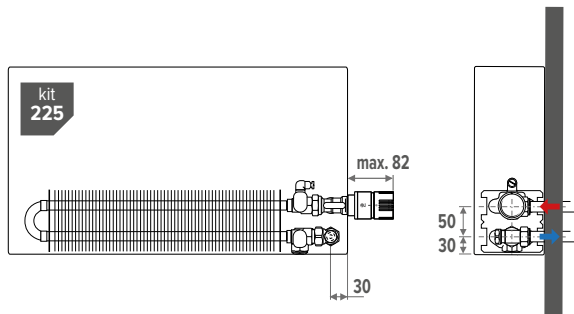

### Exemple de raccord à gauche

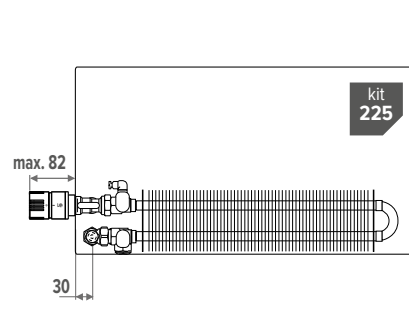

## CONNEXION À GAUCHE OU À DROITE AVEC COMMANDE AU-DESSUS

Ajoutez 30 (gauche) ou 60 (droite) au code du radiateur. EX. STRW.035 050 06 XXX 60

Jeux de raccords Eurocône possibles.: 115, 116, 117, 118

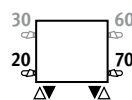

### Exemple de raccord à droite (standard)

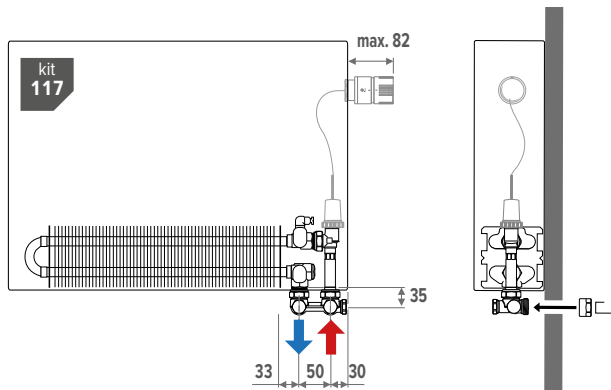

### Exemple de raccord à gauche

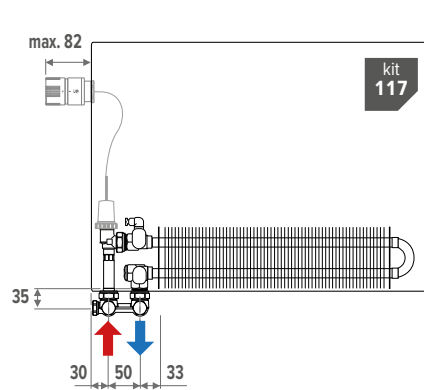

## CONNEXION À GAUCHE OU À DROITE AVEC COMMANDE À DISTANCE

Ajoutez 00 (côtés fermés) au code du radiateur. EX. STRW.035 050 06 XXX 00

Jeux de raccords Eurocône possibles.: 111, 112, 113, 114

Jeux de raccords M24 possibles: 28, 29

### Exemple de raccord à droite (standard)

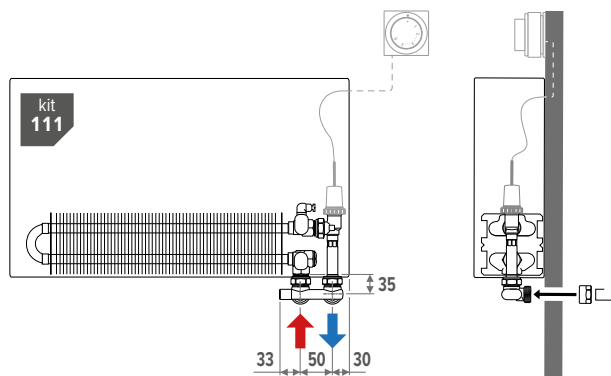

### Exemple de raccord à gauche

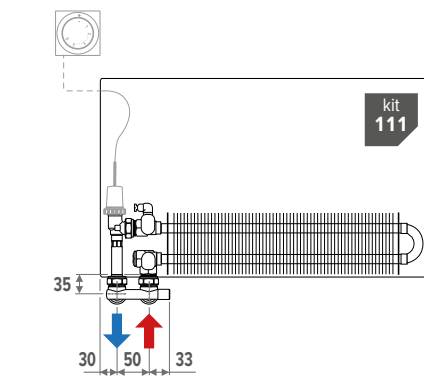

# STRADA

Informations détaillées sur les vannes, voir la brochure « Kits de raccordement & vannes »

# LES RACCORDEMENTS LES PLUS UTILISÉS

Vers le mur - DÉPART À L'EXTÉRIEUR  
Avec vanne H Jaga

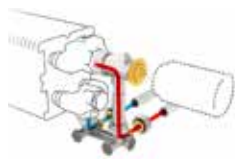

kit **103** **KVS: 0.8**  
**BITUBE / MONOTUBE**

COLO HBSW AC 4...	AC	
COLO HBSW AW 4...	AW	
COLO HBSW AS 4...	AS	
COLO HBSW AB 4...	AB	
COLO HBSW JH 4...	JH	

indiquer code raccords de serrage

Avec vanne Gampper  
Vario DP Dynamique



kit **183** contrôle automatique de débit (20 - 340 l/h)  
**BITUBE**

COLO GASW AC 4...	AC	
COLO GASW AW 4...	AW	
COLO GASW AS 4...	AS	
COLO GASW AB 4...	AB	
COLO GASW JH 4...	JH	

indiquer code raccords de serrage

Vers le sol - DÉPART À L'EXTÉRIEUR  
Avec vanne H Jaga



kit **104** **KVS: 0.8**  
**BITUBE / MONOTUBE**

COLO HBSF AC 4...	AC	
COLO HBSF AW 4...	AW	
COLO HBSF AS 4...	AS	
COLO HBSF AB 4...	AB	
COLO HBSF JH 4...	JH	

indiquer code raccords de serrage

Avec vanne Gampper  
Vario DP Dynamique

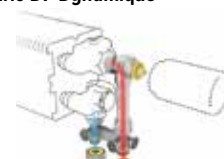

kit **184** contrôle automatique de débit (20 - 340 l/h)  
**BITUBE**

COLO GASF AC 4...	AC	
COLO GASF AW 4...	AW	
COLO GASF AS 4...	AS	
COLO GASF AB 4...	AB	
COLO GASF JH 4...	JH	

indiquer code raccords de serrage

Vers le mur - DÉPART À L'INTÉRIEUR  
Avec vanne Jaga Crossflow

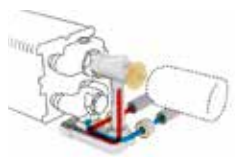

kit **101** **KVS: 0.8**  
**BITUBE**

COLO HBCW AC 4...	AC	
COLO HBCW AW 4...	AW	
COLO HBCW AS 4...	AS	
COLO HBCW AB 4...	AB	
COLO HBCW JH 4...	JH	

indiquer code raccords de serrage

Avec vanne Gampper  
Vario DP Dynamique



kit **181** contrôle automatique de débit (20 - 340 l/h)  
**BITUBE**

COLO GACW AC 4...	AC	
COLO GACW AW 4...	AW	
COLO GACW AS 4...	AS	
COLO GACW AB 4...	AB	
COLO GACW JH 4...	JH	

indiquer code raccords de serrage

Vers le sol - DÉPART À L'INTÉRIEUR  
Avec vanne Jaga Crossflow

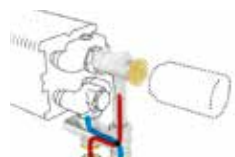

kit **102** **KVS: 0.8**  
**BITUBE**

COLO HBCF AC 4...	AC	
COLO HBCF AW 4...	AW	
COLO HBCF AS 4...	AS	
COLO HBCF AB 4...	AB	
COLO HBCF JH 4...	JH	

indiquer code raccords de serrage

Avec vanne Gampper  
Vario DP Dynamique

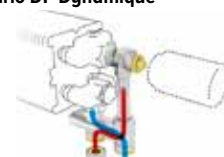

kit **182** contrôle automatique de débit (20 - 340 l/h)  
**BITUBE**

COLO GACF AC 4...	AC	
COLO GACF AW 4...	AW	
COLO GACF AS 4...	AS	
COLO GACF AB 4...	AB	
COLO GACF JH 4...	JH	

indiquer code raccords de serrage

Vers le mur - AU SEIN DE L'HABILLAGE  
Avec vanne Jaga



kit **225** **KVS: 0.8**  
**BITUBE**

COLO SW2 AC 4...	AC	
COLO SW2 AW 4...	AW	
COLO SW2 AS 4...	AS	
COLO SW2 AB 4...	AB	
COLO SW2 JH 4...	JH	

indiquer code raccords de serrage

Avec vanne Gampper  
Vario DP Dynamique



kit **285** contrôle automatique de débit (20 - 340 l/h)  
**BITUBE**

COLO GW2 AC 4...	AC	
COLO GW2 AW 4...	AW	
COLO GW2 AS 4...	AS	
COLO GW2 AB 4...	AB	
COLO GW2 JH 4...	JH	

indiquer code raccords de serrage

Avec 2 vannes de retour

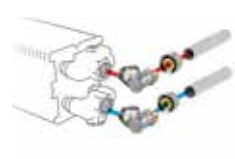

kit **226** **BITUBE**

COLO LOA 00 4...	AC	
------------------	----	--

indiquer code raccords de serrage

## Raccords bicônes 3/4» Eurocone

TUBE MÉTALLIQUE DE PRÉCISION		SYNTHÉTIQUE OU MULTICOUCHES PER/ALU	
CODE	Tuyau Ø	CODE	Tuyau Ø
112	12/1	612	12/2
114	14/1	614	14/2
115	15/1	616	16/2
116	16/1	618	18/2
118	18/1	619	16/1,5
		620	20/2

Raccord mural Strada Type 06 à l'intérieur du caisson : jeu 25



# STRADA

# HAUTEUR 020 (STANDARD)

Type 10

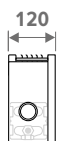

Type 15

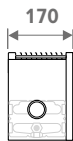

Type 20

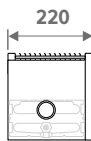

HAUTEUR H cm	LONGUEUR L cm	TYPE T	CHAUFFER Température ambiante 20°C				POIDS kg	CONTENU EN EAU L	CODE DE COMMANDE
			45/40 Watts	50/45 Watts	55/45 Watts	75/65 Watts			
STRW 020	050	---	---	---	---	---	---	---	
10	106	---	106	141	158	328	4	0.3	STRW 020 050 10 XXX
15	177	---	177	235	263	545	5	0.5	STRW 020 050 15 XXX
20	249	---	249	330	370	766	6	0.7	STRW 020 050 20 XXX
060	---	---	---	---	---	---	---	---	
10	127	---	127	169	189	393	5	0.4	STRW 020 060 10 XXX
15	212	---	212	282	316	654	6	0.6	STRW 020 060 15 XXX
20	298	---	298	396	444	919	7	0.8	STRW 020 060 20 XXX
070	---	---	---	---	---	---	---	---	
10	148	---	148	197	221	459	5	0.5	STRW 020 070 10 XXX
15	248	---	248	329	369	763	7	0.7	STRW 020 070 15 XXX
20	348	---	348	462	518	1072	8	0.9	STRW 020 070 20 XXX
080	---	---	---	---	---	---	---	---	
10	169	---	169	225	252	524	6	0.5	STRW 020 080 10 XXX
15	283	---	283	376	421	872	7	0.8	STRW 020 080 15 XXX
20	398	---	398	529	592	1226	9	1.1	STRW 020 080 20 XXX
090	---	---	---	---	---	---	---	---	
10	191	---	191	254	284	590	6	0.6	STRW 020 090 10 XXX
15	318	---	318	423	474	981	8	0.9	STRW 020 090 15 XXX
20	448	---	448	595	666	1379	10	1.2	STRW 020 090 20 XXX
100	---	---	---	---	---	---	---	---	
10	212	---	212	282	316	655	7	0.7	STRW 020 100 10 XXX
15	354	---	354	470	526	1090	9	1.0	STRW 020 100 15 XXX
20	497	---	497	661	740	1532	11	1.3	STRW 020 100 20 XXX
110	---	---	---	---	---	---	---	---	
10	233	---	233	310	347	721	8	0.7	STRW 020 110 10 XXX
15	389	---	389	517	579	1199	10	1.1	STRW 020 110 15 XXX
20	547	---	547	727	814	1685	12	1.5	STRW 020 110 20 XXX
120	---	---	---	---	---	---	---	---	
10	254	---	254	338	379	786	8	0.8	STRW 020 120 10 XXX
15	424	---	424	564	632	1308	11	1.2	STRW 020 120 15 XXX
20	596	---	596	793	888	1838	13	1.6	STRW 020 120 20 XXX
140	---	---	---	---	---	---	---	---	
10	296	---	296	394	442	917	10	0.8	STRW 020 140 10 XXX
15	495	---	495	658	737	1526	12	1.2	STRW 020 140 15 XXX
20	696	---	696	925	1036	2145	15	1.6	STRW 020 140 20 XXX
160	---	---	---	---	---	---	---	---	
10	339	---	339	451	505	1048	11	1.0	STRW 020 160 10 XXX
15	566	---	566	752	842	1744	14	1.6	STRW 020 160 15 XXX
20	795	---	795	1057	1184	2451	17	2.1	STRW 020 160 20 XXX
180	---	---	---	---	---	---	---	---	
10	381	---	381	507	568	1179	12	1.2	STRW 020 180 10 XXX
15	637	---	637	846	948	1962	15	1.8	STRW 020 180 15 XXX
20	895	---	895	1190	1332	2758	19	2.4	STRW 020 180 20 XXX
200	---	---	---	---	---	---	---	---	
10	423	---	423	563	631	1310	13	1.3	STRW 020 200 10 XXX
15	707	---	707	940	1053	2180	17	2.0	STRW 020 200 15 XXX
20	994	---	994	1322	1480	3064	21	2.6	STRW 020 200 20 XXX
220	---	---	---	---	---	---	---	---	
10	466	---	466	620	694	1441	1.4	---	STRW 020 220 10 XXX
15	778	---	778	1034	1158	2398	2.2	---	STRW 020 220 15 XXX
20	1094	---	1094	1454	1628	3370	2.9	---	STRW 020 220 20 XXX
240	---	---	---	---	---	---	---	---	
10	508	---	508	676	757	1572	16	1.6	STRW 020 240 10 XXX
15	849	---	849	1128	1264	2616	20	2.4	STRW 020 240 15 XXX
20	1193	---	1193	1586	1776	3677	25	3.2	STRW 020 240 20 XXX
260	---	---	---	---	---	---	---	---	
10	550	---	550	732	820	1703	1.7	---	STRW 020 260 10 XXX
15	920	---	920	1222	1369	2834	2.5	---	STRW 020 260 15 XXX
20	1293	---	1293	1718	1924	3983	3.4	---	STRW 020 260 20 XXX
280	---	---	---	---	---	---	---	---	
10	593	---	593	789	884	1834	19	1.8	STRW 020 280 10 XXX
15	990	---	990	1316	1474	3052	24	2.7	STRW 020 280 15 XXX
20	1392	---	1392	1850	2072	4290	29	3.7	STRW 020 280 20 XXX

Emission EN442 à 20°C

remplir code de couleur



Type 06

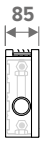

HAUTEUR H cm	LONGUEUR L cm	TYPE T	CHAUFFER Température ambiante 20°C				POIDS kg	CONTENU EN EAU L	CODE DE COMMANDE
			45/40 Watts	50/45 Watts	55/45 Watts	75/65 Watts			
STRW 020	050	06	87	116	130	269	4	0.3	STRW 020 050 06 XXX
		11	---	---	---	---	---	---	---
		16	---	---	---	---	---	---	---
		21	---	---	---	---	---	---	---
	060	06	105	139	156	323	4	0.4	STRW 020 060 06 XXX
		11	---	---	---	---	---	---	---
		16	---	---	---	---	---	---	---
		21	---	---	---	---	---	---	---
	070	06	122	162	182	377	5	0.4	STRW 020 070 06 XXX
		11	---	---	---	---	---	---	---
		16	---	---	---	---	---	---	---
		21	---	---	---	---	---	---	---
080	06	139	185	207	430	5	0.5	STRW 020 080 06 XXX	
	11	---	---	---	---	---	---	---	
	16	---	---	---	---	---	---	---	
	21	---	---	---	---	---	---	---	
090	06	157	209	234	484	6	0.6	STRW 020 090 06 XXX	
	11	---	---	---	---	---	1.2	---	
	16	---	---	---	---	---	---	---	
	21	---	---	---	---	---	---	---	
100	06	174	232	260	538	6	0.6	STRW 020 100 06 XXX	
	11	---	---	---	---	---	---	---	
	16	---	---	---	---	---	---	---	
	21	---	---	---	---	---	---	---	
110	06	192	255	286	592	7	0.7	STRW 020 110 06 XXX	
	11	---	---	---	---	---	---	---	
	16	---	---	---	---	---	---	---	
	21	---	---	---	---	---	---	---	
120	06	209	278	312	646	7	0.8	STRW 020 120 06 XXX	
	11	---	---	---	---	---	---	---	
	16	---	---	---	---	---	---	---	
	21	---	---	---	---	---	---	---	
140	06	244	324	363	753	8	0.8	STRW 020 140 06 XXX	
	11	---	---	---	---	---	---	---	
	16	---	---	---	---	---	---	---	
	21	---	---	---	---	---	---	---	
160	06	279	371	415	861	10	1.0	STRW 020 160 06 XXX	
	11	---	---	---	---	---	---	---	
	16	---	---	---	---	---	---	---	
	21	---	---	---	---	---	---	---	
180	06	314	417	467	968	11	1.2	STRW 020 180 06 XXX	
	11	---	---	---	---	---	---	---	
	16	---	---	---	---	---	---	---	
	21	---	---	---	---	---	---	---	
200	06	349	464	519	1076	12	1.3	STRW 020 200 06 XXX	
	11	---	---	---	---	---	---	---	
	16	---	---	---	---	---	---	---	
	21	---	---	---	---	---	---	---	
220	06	384	510	571	1184	14	1.4	STRW 020 220 06 XXX	
	11	---	---	---	---	---	---	---	
	16	---	---	---	---	---	---	---	
	21	---	---	---	---	---	---	---	
240	06	418	556	623	1291	14	1.5	STRW 020 240 06 XXX	
	11	---	---	---	---	---	---	---	
	16	---	---	---	---	---	---	---	
	21	---	---	---	---	---	---	---	
260	06	453	603	675	1399	16	1.7	STRW 020 260 06 XXX	
	11	---	---	---	---	---	---	---	
	16	---	---	---	---	---	---	---	
	21	---	---	---	---	---	---	---	
280	06	488	649	727	1506	16	1.8	STRW 020 280 06 XXX	
	11	---	---	---	---	---	---	---	
	16	---	---	---	---	---	---	---	
	21	---	---	---	---	---	---	---	

Émission EN442 à 20°C

remplir code de couleur

# STRADA

# HAUTEUR 035 (STANDARD)

Type 10

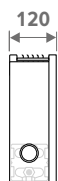

Type 15

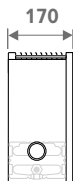

Type 20

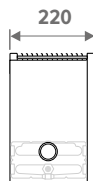

HAUTEUR H cm	LONGUEUR L cm	TYPE T	CHAUFFER Temperature ambiante 20°C				POIDS kg	CONTENU EN EAU L	CODE DE COMMANDE
			45/40 Watts	50/45 Watts	55/45 Watts	75/65 Watts			
STRW 035	050	---	---	---	---	---	---	---	
10	147	195	218	449	5	0.3	STRW 035 050 10 XXX		
15	242	320	358	735	7	0.5	STRW 035 050 15 XXX		
20	339	449	502	1030	8	0.7	STRW 035 050 20 XXX		
060	---	---	---	---	---	---	---		
10	176	234	262	539	6	0.4	STRW 035 060 10 XXX		
15	290	385	430	882	8	0.6	STRW 035 060 15 XXX		
20	407	539	603	1236	9	0.8	STRW 035 060 20 XXX		
070	---	---	---	---	---	---	---		
10	206	273	305	629	7	0.5	STRW 035 070 10 XXX		
15	339	449	502	1029	9	0.7	STRW 035 070 15 XXX		
20	475	629	703	1442	10	0.9	STRW 035 070 20 XXX		
080	---	---	---	---	---	---	---		
10	235	311	348	718	8	0.5	STRW 035 080 10 XXX		
15	387	513	573	1176	10	0.8	STRW 035 080 15 XXX		
20	543	718	803	1648	11	1.1	STRW 035 080 20 XXX		
090	---	---	---	---	---	---	---		
10	264	350	392	808	9	0.6	STRW 035 090 10 XXX		
15	436	577	645	1323	10	0.9	STRW 035 090 15 XXX		
20	610	808	904	1854	13	1.2	STRW 035 090 20 XXX		
100	---	---	---	---	---	---	---		
10	294	389	436	898	9	0.7	STRW 035 100 10 XXX		
15	484	641	717	1470	11	1.0	STRW 035 100 15 XXX		
20	678	898	1004	2060	14	1.3	STRW 035 100 20 XXX		
110	---	---	---	---	---	---	---		
10	323	428	479	988	10	0.7	STRW 035 110 10 XXX		
15	532	705	788	1617	12	1.1	STRW 035 110 15 XXX		
20	746	988	1105	2266	15	1.5	STRW 035 110 20 XXX		
120	---	---	---	---	---	---	---		
10	352	467	523	1078	11	0.8	STRW 035 120 10 XXX		
15	581	769	860	1764	13	1.2	STRW 035 120 15 XXX		
20	814	1078	1205	2472	16	1.6	STRW 035 120 20 XXX		
140	---	---	---	---	---	---	---		
10	411	545	610	1257	13	0.8	STRW 035 140 10 XXX		
15	678	897	1003	2058	16	1.2	STRW 035 140 15 XXX		
20	949	1257	1406	2884	19	1.6	STRW 035 140 20 XXX		
160	---	---	---	---	---	---	---		
10	470	623	697	1437	14	1.0	STRW 035 160 10 XXX		
15	774	1025	1147	2352	18	1.6	STRW 035 160 15 XXX		
20	1085	1437	1607	3296	21	2.1	STRW 035 160 20 XXX		
180	---	---	---	---	---	---	---		
10	528	701	784	1616	16	1.2	STRW 035 180 10 XXX		
15	871	1154	1290	2646	20	1.8	STRW 035 180 15 XXX		
20	1221	1617	1808	3708	23	2.4	STRW 035 180 20 XXX		
200	---	---	---	---	---	---	---		
10	587	779	872	1796	17	1.3	STRW 035 200 10 XXX		
15	968	1282	1433	2940	21	2.0	STRW 035 200 15 XXX		
20	1356	1796	2009	4120	25	2.6	STRW 035 200 20 XXX		
220	---	---	---	---	---	---	---		
10	695	922	1031	2119	14	1.4	STRW 035 220 10 XXX		
15	1140	1509	1686	3450	22	2.2	STRW 035 220 15 XXX		
20	1598	2114	2363	4831	29	2.9	STRW 035 220 20 XXX		
240	---	---	---	---	---	---	---		
10	704	934	1046	2155	21	1.6	STRW 035 240 10 XXX		
15	1161	1538	1720	3528	26	2.4	STRW 035 240 15 XXX		
20	1628	2155	2410	4944	30	3.2	STRW 035 240 20 XXX		
260	---	---	---	---	---	---	---		
10	822	1089	1218	2504	17	1.7	STRW 035 260 10 XXX		
15	1348	1783	1993	4077	25	2.5	STRW 035 260 15 XXX		
20	1889	2498	2792	5710	34	3.4	STRW 035 260 20 XXX		
280	---	---	---	---	---	---	---		
10	822	1090	1220	2514	24	1.8	STRW 035 280 10 XXX		
15	1355	1794	2007	4116	29	2.7	STRW 035 280 15 XXX		
20	1899	2515	2812	5768	35	3.7	STRW 035 280 20 XXX		

Emission EN442 à 20°C

remplir code de couleur

Type 06

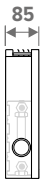

Type 11

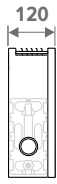

Type 16

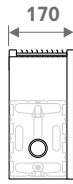

Type 21

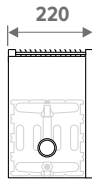

HAUTEUR H cm	LONGUEUR L cm	TYPE T	CHAUFFEUR Température ambiante 20°C				POIDS kg	CONTENU EN EAU L	CODE DE COMMANDE
			45/40 Watts	50/45 Watts	55/45 Watts	75/65 Watts			
<b>STRW 035 050</b>	<b>06</b>	<b>06</b>	130	172	192	395	5	0.3	STRW 035 050 06 XXX
		<b>11</b>	189	253	284	598	6	0.7	STRW 035 050 11 XXX
		<b>16</b>	249	334	375	797	8	1.0	STRW 035 050 16 XXX
		<b>21</b>	326	439	494	1057	9	1.3	STRW 035 050 21 XXX
<b>060</b>	<b>06</b>	<b>06</b>	156	206	231	474	6	0.4	STRW 035 060 06 XXX
		<b>11</b>	227	304	341	718	7	0.8	STRW 035 060 11 XXX
		<b>16</b>	298	400	450	956	9	1.2	STRW 035 060 16 XXX
		<b>21</b>	391	526	593	1268	11	1.6	STRW 035 060 21 XXX
<b>070</b>	<b>06</b>	<b>06</b>	182	241	269	553	6	0.4	STRW 035 070 06 XXX
		<b>11</b>	265	354	398	837	8	0.9	STRW 035 070 11 XXX
		<b>16</b>	348	467	525	1115	10	1.4	STRW 035 070 16 XXX
		<b>21</b>	456	614	692	1480	12	1.9	STRW 035 070 21 XXX
<b>080</b>	<b>06</b>	<b>06</b>	208	275	308	632	7	0.5	STRW 035 080 06 XXX
		<b>11</b>	303	405	455	957	9	1.1	STRW 035 080 11 XXX
		<b>16</b>	397	533	600	1274	11	1.6	STRW 035 080 16 XXX
		<b>21</b>	521	702	790	1691	13	2.1	STRW 035 080 21 XXX
<b>090</b>	<b>06</b>	<b>06</b>	234	309	346	711	8	0.6	STRW 035 090 06 XXX
		<b>11</b>	340	455	511	1076	10	1.2	STRW 035 090 11 XXX
		<b>16</b>	447	600	675	1434	13	1.8	STRW 035 090 16 XXX
		<b>21</b>	587	790	889	1903	15	2.4	STRW 035 090 21 XXX
<b>100</b>	<b>06</b>	<b>06</b>	259	344	385	790	9	0.6	STRW 035 100 06 XXX
		<b>11</b>	378	506	568	1196	11	1.3	STRW 035 100 11 XXX
		<b>16</b>	497	667	750	1593	14	2.0	STRW 035 100 16 XXX
		<b>21</b>	652	878	988	2114	16	2.7	STRW 035 100 21 XXX
<b>110</b>	<b>06</b>	<b>06</b>	285	378	423	869	9	0.7	STRW 035 110 06 XXX
		<b>11</b>	416	557	625	1316	12	1.5	STRW 035 110 11 XXX
		<b>16</b>	546	733	825	1752	15	2.2	STRW 035 110 16 XXX
		<b>21</b>	717	965	1086	2325	18	2.9	STRW 035 110 21 XXX
<b>120</b>	<b>06</b>	<b>06</b>	311	413	461	948	10	0.8	STRW 035 120 06 XXX
		<b>11</b>	454	607	682	1435	13	1.6	STRW 035 120 11 XXX
		<b>16</b>	596	800	900	1912	16	2.4	STRW 035 120 16 XXX
		<b>21</b>	782	1053	1186	2537	19	3.2	STRW 035 120 21 XXX
<b>140</b>	<b>06</b>	<b>06</b>	363	481	538	1106	12	0.8	STRW 035 140 06 XXX
		<b>11</b>	530	708	795	1674	15	1.6	STRW 035 140 11 XXX
		<b>16</b>	695	934	1050	2230	19	2.4	STRW 035 140 16 XXX
		<b>21</b>	913	1229	1383	2960	23	3.2	STRW 035 140 21 XXX
<b>160</b>	<b>06</b>	<b>06</b>	415	550	615	1264	13	1.0	STRW 035 160 06 XXX
		<b>11</b>	605	810	909	1914	17	2.1	STRW 035 160 11 XXX
		<b>16</b>	795	1067	1200	2549	21	3.2	STRW 035 160 16 XXX
		<b>21</b>	1043	1404	1580	3382	25	4.3	STRW 035 160 21 XXX
<b>180</b>	<b>06</b>	<b>06</b>	467	619	692	1422	15	1.2	STRW 035 180 06 XXX
		<b>11</b>	681	911	1023	2153	19	2.4	STRW 035 180 11 XXX
		<b>16</b>	894	1200	1349	2867	23	3.6	STRW 035 180 16 XXX
		<b>21</b>	1173	1580	1778	3805	28	4.8	STRW 035 180 21 XXX
<b>200</b>	<b>06</b>	<b>06</b>	519	688	769	1580	16	1.3	STRW 035 200 06 XXX
		<b>11</b>	757	1012	1136	2392	20	2.7	STRW 035 200 11 XXX
		<b>16</b>	993	1334	1500	3186	25	4.0	STRW 035 200 16 XXX
		<b>21</b>	1304	1755	1976	4228	31	5.3	STRW 035 200 21 XXX
<b>220</b>	<b>06</b>	<b>06</b>	586	771	861	1738	1.4		STRW 035 220 06 XXX
		<b>11</b>	880	1177	1322	2781	2.9		STRW 035 220 11 XXX
		<b>16</b>	1164	1564	1759	3740	4.4		STRW 035 220 16 XXX
		<b>21</b>	1536	2071	2332	5003	5.9		STRW 035 220 21 XXX
<b>240</b>	<b>06</b>	<b>06</b>	623	825	923	1896	20	1.5	STRW 035 240 06 XXX
		<b>11</b>	908	1214	1363	2870	24	3.2	STRW 035 240 11 XXX
		<b>16</b>	1192	1600	1799	3823	30	4.8	STRW 035 240 16 XXX
		<b>21</b>	1564	2106	2371	5074	37	6.4	STRW 035 240 21 XXX
<b>260</b>	<b>06</b>	<b>06</b>	693	912	1017	2054	1.7		STRW 035 260 06 XXX
		<b>11</b>	1040	1391	1562	3286	3.5		STRW 035 260 11 XXX
		<b>16</b>	1376	1848	2078	4420	5.1		STRW 035 260 16 XXX
		<b>21</b>	1816	2447	2755	5912	6.9		STRW 035 260 21 XXX
<b>280</b>	<b>06</b>	<b>06</b>	726	963	1077	2212	22	1.8	STRW 035 280 06 XXX
		<b>11</b>	1059	1417	1591	3349	28	3.7	STRW 035 280 11 XXX
		<b>16</b>	1391	1867	2099	4460	34	5.5	STRW 035 280 16 XXX
		<b>21</b>	1825	2457	2766	5919	43	7.4	STRW 035 280 21 XXX

Émission EN442 à 20°C

remplir code de couleur

# STRADA

# HAUTEUR 050 (STANDARD)

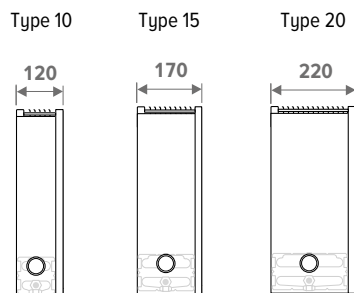

HAUTEUR H cm	LONGUEUR L cm	TYPE T	CHAUFFER Température ambiante 20°C				POIDS kg	CONTENU EN EAU L	CODE DE COMMANDE
			45/40 Watts	50/45 Watts	55/45 Watts	75/65 Watts			
STRW 050	050	---	---	---	---	---	---	---	
10	178	235	263	538	7	0.3	STRW 050 050 10 XXX		
15	289	382	426	867	8	0.5	STRW 050 050 15 XXX		
20	405	534	597	1213	10	0.7	STRW 050 050 20 XXX		
060	---	---	---	---	---	---	---		
10	214	282	316	646	8	0.4	STRW 050 060 10 XXX		
15	347	458	511	1040	9	0.6	STRW 050 060 15 XXX		
20	486	641	716	1455	11	0.8	STRW 050 060 20 XXX		
070	---	---	---	---	---	---	---		
10	249	329	368	753	9	0.5	STRW 050 070 10 XXX		
15	405	535	597	1214	11	0.7	STRW 050 070 15 XXX		
20	567	748	835	1698	12	0.9	STRW 050 070 20 XXX		
080	---	---	---	---	---	---	---		
10	285	376	421	861	10	0.5	STRW 050 080 10 XXX		
15	463	611	682	1387	12	0.8	STRW 050 080 15 XXX		
20	647	854	954	1940	14	1.1	STRW 050 080 20 XXX		
090	---	---	---	---	---	---	---		
10	320	423	473	968	11	0.6	STRW 050 090 10 XXX		
15	521	687	768	1561	13	0.9	STRW 050 090 15 XXX		
20	729	961	1074	2183	15	1.2	STRW 050 090 20 XXX		
100	---	---	---	---	---	---	---		
10	356	471	526	1076	12	0.7	STRW 050 100 10 XXX		
15	579	764	853	1734	14	1.0	STRW 050 100 15 XXX		
20	809	1068	1193	2425	16	1.3	STRW 050 100 20 XXX		
110	---	---	---	---	---	---	---		
10	391	518	579	1184	12	0.7	STRW 050 110 10 XXX		
15	636	840	938	1907	15	1.1	STRW 050 110 15 XXX		
20	890	1175	1312	2668	18	1.5	STRW 050 110 20 XXX		
120	---	---	---	---	---	---	---		
10	427	565	631	1291	13	0.8	STRW 050 120 10 XXX		
15	694	917	1023	2081	16	1.2	STRW 050 120 15 XXX		
20	971	1282	1431	2910	19	1.6	STRW 050 120 20 XXX		
140	---	---	---	---	---	---	---		
10	498	659	736	1506	16	0.8	STRW 050 140 10 XXX		
15	810	1069	1194	2428	19	1.2	STRW 050 140 15 XXX		
20	1133	1495	1670	3395	22	1.6	STRW 050 140 20 XXX		
160	---	---	---	---	---	---	---		
10	569	753	842	1722	18	1.0	STRW 050 160 10 XXX		
15	926	1222	1364	2774	21	1.6	STRW 050 160 15 XXX		
20	1295	1709	1908	3880	25	2.1	STRW 050 160 20 XXX		
180	---	---	---	---	---	---	---		
10	640	847	947	1937	20	1.2	STRW 050 180 10 XXX		
15	1042	1375	1535	3121	23	1.8	STRW 050 180 15 XXX		
20	1457	1922	2147	4365	27	2.4	STRW 050 180 20 XXX		
200	---	---	---	---	---	---	---		
10	711	941	1052	2152	21	1.3	STRW 050 200 10 XXX		
15	1157	1527	1706	3468	26	2.0	STRW 050 200 15 XXX		
20	1619	2136	2385	4850	30	2.6	STRW 050 200 20 XXX		
220	---	---	---	---	---	---	---		
10	782	1035	1157	2367	1.4	---	STRW 050 220 10 XXX		
15	1273	1680	1876	3815	2.2	---	STRW 050 220 15 XXX		
20	1780	2350	2624	5335	2.9	---	STRW 050 220 20 XXX		
240	---	---	---	---	---	---	---		
10	853	1129	1262	2582	26	1.6	STRW 050 240 10 XXX		
15	1389	1833	2047	4162	31	2.4	STRW 050 240 15 XXX		
20	1942	2563	2862	5820	36	3.2	STRW 050 240 20 XXX		
260	---	---	---	---	---	---	---		
10	925	1223	1368	2798	1.7	---	STRW 050 260 10 XXX		
15	1504	1985	2217	4508	2.5	---	STRW 050 260 15 XXX		
20	2104	2777	3101	6305	3.4	---	STRW 050 260 20 XXX		
280	---	---	---	---	---	---	---		
10	996	1318	1473	3013	29	1.8	STRW 050 280 10 XXX		
15	1620	2138	2388	4855	35	2.7	STRW 050 280 15 XXX		
20	2266	2990	3339	6790	41	3.7	STRW 050 280 20 XXX		

Émission EN442 à 20°C

remplir code de couleur

# STRADA

# HAUTEUR 050 (TWIN)

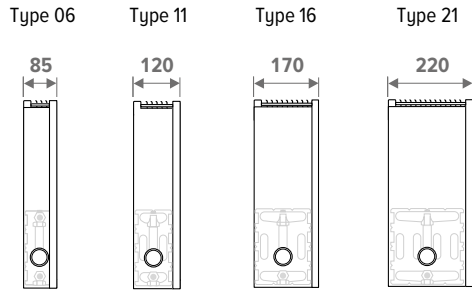

HAUTEUR H cm	LONGUEUR L cm	TYPE T	CHAUFFEUR Temperature ambiante 20°C				POIDS kg	CONTENU EN EAU L	CODE DE COMMANDE
			45/40 Watts	50/45 Watts	55/45 Watts	75/65 Watts			
<b>STRW 050</b>	<b>050</b>	<b>06</b>	158	209	233	474	6	0.3	STRW 050 050 06 XXX
		<b>11</b>	220	294	330	693	8	0.7	STRW 050 050 11 XXX
		<b>16</b>	294	396	445	949	10	1.0	STRW 050 050 16 XXX
		<b>21</b>	394	532	599	1291	11	1.3	STRW 050 050 21 XXX
<b>060</b>	<b>06</b>	<b>06</b>	190	250	279	568	7	0.4	STRW 050 060 06 XXX
		<b>11</b>	264	352	396	832	9	0.8	STRW 050 060 11 XXX
		<b>16</b>	353	475	534	1139	11	1.2	STRW 050 060 16 XXX
		<b>21</b>	473	638	719	1549	13	1.6	STRW 050 060 21 XXX
<b>070</b>	<b>06</b>	<b>06</b>	221	292	326	663	8	0.4	STRW 050 070 06 XXX
		<b>11</b>	307	411	461	970	10	0.9	STRW 050 070 11 XXX
		<b>16</b>	412	554	624	1329	12	1.4	STRW 050 070 16 XXX
		<b>21</b>	551	744	839	1807	14	1.9	STRW 050 070 21 XXX
<b>080</b>	<b>06</b>	<b>06</b>	253	334	373	758	9	0.5	STRW 050 080 06 XXX
		<b>11</b>	351	470	527	1109	11	1.1	STRW 050 080 11 XXX
		<b>16</b>	471	633	712	1518	13	1.6	STRW 050 080 16 XXX
		<b>21</b>	630	851	959	2066	16	2.1	STRW 050 080 21 XXX
<b>090</b>	<b>06</b>	<b>06</b>	285	375	419	852	10	0.6	STRW 050 090 06 XXX
		<b>11</b>	395	528	593	1247	12	1.2	STRW 050 090 11 XXX
		<b>16</b>	530	712	801	1708	15	1.8	STRW 050 090 16 XXX
		<b>21</b>	709	957	1079	2324	18	2.4	STRW 050 090 21 XXX
<b>100</b>	<b>06</b>	<b>06</b>	316	417	466	947	11	0.6	STRW 050 100 06 XXX
		<b>11</b>	439	587	659	1386	13	1.3	STRW 050 100 11 XXX
		<b>16</b>	589	792	891	1898	16	2.0	STRW 050 100 16 XXX
		<b>21</b>	788	1064	1198	2582	19	2.7	STRW 050 100 21 XXX
<b>110</b>	<b>06</b>	<b>06</b>	348	459	513	1042	12	0.7	STRW 050 110 06 XXX
		<b>11</b>	483	646	725	1525	14	1.5	STRW 050 110 11 XXX
		<b>16</b>	648	871	980	2088	17	2.2	STRW 050 110 16 XXX
		<b>21</b>	867	1170	1318	2840	21	2.9	STRW 050 110 21 XXX
<b>120</b>	<b>06</b>	<b>06</b>	379	501	559	1136	13	0.8	STRW 050 120 06 XXX
		<b>11</b>	527	705	791	1663	15	1.6	STRW 050 120 11 XXX
		<b>16</b>	707	950	1069	2278	19	2.4	STRW 050 120 16 XXX
		<b>21</b>	945	1276	1438	3098	22	3.2	STRW 050 120 21 XXX
<b>140</b>	<b>06</b>	<b>06</b>	443	584	652	1326	15	0.8	STRW 050 140 06 XXX
		<b>11</b>	615	822	923	1940	18	1.6	STRW 050 140 11 XXX
		<b>16</b>	825	1108	1247	2657	23	2.4	STRW 050 140 16 XXX
		<b>21</b>	1103	1489	1678	3615	27	3.2	STRW 050 140 21 XXX
<b>160</b>	<b>06</b>	<b>06</b>	506	668	745	1515	16	1.0	STRW 050 160 06 XXX
		<b>11</b>	703	940	1055	2218	20	2.1	STRW 050 160 11 XXX
		<b>16</b>	942	1267	1425	3037	25	3.2	STRW 050 160 16 XXX
		<b>21</b>	1261	1702	1917	4131	29	4.3	STRW 050 160 21 XXX
<b>180</b>	<b>06</b>	<b>06</b>	569	751	839	1705	18	1.2	STRW 050 180 06 XXX
		<b>11</b>	790	1057	1187	2495	22	2.4	STRW 050 180 11 XXX
		<b>16</b>	1060	1425	1603	3416	27	3.6	STRW 050 180 16 XXX
		<b>21</b>	1418	1915	2157	4648	32	4.8	STRW 050 180 21 XXX
<b>200</b>	<b>06</b>	<b>06</b>	633	835	932	1894	20	1.3	STRW 050 200 06 XXX
		<b>11</b>	878	1174	1318	2772	24	2.7	STRW 050 200 11 XXX
		<b>16</b>	1178	1583	1781	3796	29	4.0	STRW 050 200 16 XXX
		<b>21</b>	1576	2127	2397	5164	36	5.3	STRW 050 200 21 XXX
<b>220</b>	<b>06</b>	<b>06</b>	691	914	1021	2083	1.4	STRW 050 220 06 XXX	
		<b>11</b>	966	1292	1450	3049	2.9	STRW 050 220 11 XXX	
		<b>16</b>	1296	1742	1959	4176	4.4	STRW 050 220 16 XXX	
		<b>21</b>	1733	2340	2636	5680	5.9	STRW 050 220 21 XXX	
<b>240</b>	<b>06</b>	<b>06</b>	759	1002	1118	2273	24	1.5	STRW 050 240 06 XXX
		<b>11</b>	1054	1409	1582	3326	29	3.2	STRW 050 240 11 XXX
		<b>16</b>	1413	1900	2137	4555	35	4.8	STRW 050 240 16 XXX
		<b>21</b>	1891	2553	2876	6197	42	6.4	STRW 050 240 21 XXX
<b>260</b>	<b>06</b>	<b>06</b>	817	1080	1206	2462	1.7	STRW 050 260 06 XXX	
		<b>11</b>	1142	1527	1714	3604	3.5	STRW 050 260 11 XXX	
		<b>16</b>	1531	2058	2316	4935	5.1	STRW 050 260 16 XXX	
		<b>21</b>	2048	2765	3116	6713	6.9	STRW 050 260 21 XXX	
<b>280</b>	<b>06</b>	<b>06</b>	886	1169	1305	2652	28	1.8	STRW 050 280 06 XXX
		<b>11</b>	1230	1644	1846	3881	34	3.7	STRW 050 280 11 XXX
		<b>16</b>	1649	2217	2493	5314	40	5.5	STRW 050 280 16 XXX
		<b>21</b>	2206	2978	3356	7230	49	7.4	STRW 050 280 21 XXX

Émission EN442 à 20°C

remplir code de couleur

# STRADA

# HAUTEUR 065 (STANDARD)

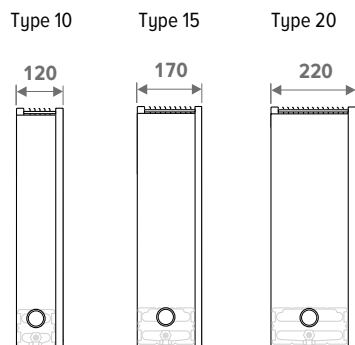

HAUTEUR H cm	LONGUEUR L cm	TYPE T	CHAUFFER Température ambiante 20°C				POIDS kg	CONTENU EN EAU L	CODE DE COMMANDE
			45/40 Watts	50/45 Watts	55/45 Watts	75/65 Watts			
STRW 065	050	---	---	---	---	---	---	---	
		10	203	267	298	606	8	0.3	STRW 065 050 10 XXX
		15	325	428	477	961	10	0.5	STRW 065 050 15 XXX
	20	455	598	667	1343	12	0.7	STRW 065 050 20 XXX	
060	---	---	---	---	---	---	---	---	
	10	243	321	358	727	10	0.4	STRW 065 060 10 XXX	
	15	390	513	572	1153	11	0.6	STRW 065 060 15 XXX	
	20	545	717	800	1611	13	0.8	STRW 065 060 20 XXX	
070	---	---	---	---	---	---	---	---	
	10	283	374	417	848	11	0.5	STRW 065 070 10 XXX	
	15	455	599	668	1345	13	0.7	STRW 065 070 15 XXX	
	20	636	837	933	1880	15	0.9	STRW 065 070 20 XXX	
080	---	---	---	---	---	---	---	---	
	10	324	427	477	969	12	0.5	STRW 065 080 10 XXX	
	15	521	685	763	1538	14	0.8	STRW 065 080 15 XXX	
	20	727	956	1066	2148	16	1.1	STRW 065 080 20 XXX	
090	---	---	---	---	---	---	---	---	
	10	364	481	537	1090	13	0.6	STRW 065 090 10 XXX	
	15	586	770	859	1730	15	0.9	STRW 065 090 15 XXX	
	20	818	1076	1200	2417	18	1.2	STRW 065 090 20 XXX	
100	---	---	---	---	---	---	---	---	
	10	405	534	596	1211	14	0.7	STRW 065 100 10 XXX	
	15	651	856	954	1922	16	1.0	STRW 065 100 15 XXX	
	20	909	1195	1333	2685	19	1.3	STRW 065 100 20 XXX	
110	---	---	---	---	---	---	---	---	
	10	445	587	656	1332	15	0.7	STRW 065 110 10 XXX	
	15	716	941	1049	2114	18	1.1	STRW 065 110 15 XXX	
	20	1000	1315	1466	2954	20	1.5	STRW 065 110 20 XXX	
120	---	---	---	---	---	---	---	---	
	10	486	641	715	1453	16	0.8	STRW 065 120 10 XXX	
	15	781	1027	1145	2306	19	1.2	STRW 065 120 15 XXX	
	20	1091	1434	1599	3222	22	1.6	STRW 065 120 20 XXX	
140	---	---	---	---	---	---	---	---	
	10	567	747	835	1695	19	0.8	STRW 065 140 10 XXX	
	15	911	1198	1336	2691	22	1.2	STRW 065 140 15 XXX	
	20	1273	1673	1866	3759	26	1.6	STRW 065 140 20 XXX	
160	---	---	---	---	---	---	---	---	
	10	648	855	954	1938	21	1.0	STRW 065 160 10 XXX	
	15	1041	1369	1526	3075	25	1.6	STRW 065 160 15 XXX	
	20	1454	1912	2133	4296	29	2.1	STRW 065 160 20 XXX	
180	---	---	---	---	---	---	---	---	
	10	729	961	1073	2180	23	1.2	STRW 065 180 10 XXX	
	15	1171	1540	1718	3460	27	1.8	STRW 065 180 15 XXX	
	20	1636	2152	2399	4833	32	2.4	STRW 065 180 20 XXX	
200	---	---	---	---	---	---	---	---	
	10	810	1068	1192	2422	25	1.3	STRW 065 200 10 XXX	
	15	1301	1711	1908	3844	30	2.0	STRW 065 200 15 XXX	
	20	1818	2391	2666	5370	34	2.6	STRW 065 200 20 XXX	
220	---	---	---	---	---	---	---	---	
	10	922	1214	1355	2746	1.4	---	STRW 065 220 10 XXX	
	15	1475	1937	2159	4338	2.2	---	STRW 065 220 15 XXX	
	20	2061	2706	3016	6057	2.9	---	STRW 065 220 20 XXX	
240	---	---	---	---	---	---	---	---	
	10	971	1281	1431	2906	31	1.6	STRW 065 240 10 XXX	
	15	1562	2054	2290	4613	36	2.4	STRW 065 240 15 XXX	
	20	2182	2869	3199	6444	41	3.2	STRW 065 240 20 XXX	
260	---	---	---	---	---	---	---	---	
	10	1089	1435	1602	3245	1.7	---	STRW 065 260 10 XXX	
	15	1743	2289	2552	5127	2.5	---	STRW 065 260 15 XXX	
	20	2435	3198	3564	7158	3.4	---	STRW 065 260 20 XXX	
280	---	---	---	---	---	---	---	---	
	10	1133	1495	1669	3391	35	1.8	STRW 065 280 10 XXX	
	15	1822	2396	2672	5382	41	2.7	STRW 065 280 15 XXX	
	20	2545	3347	3732	7518	47	3.7	STRW 065 280 20 XXX	

Emission EN442 à 20°C

remplir code de couleur

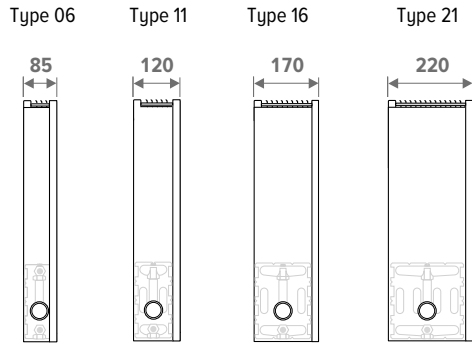

HAUTEUR H cm	LONGUEUR L cm	TYPE T	CHAUFFEUR Température ambiante 20°C				POIDS kg	CONTENU EN EAU L	CODE DE COMMANDE
			45/40 Watts	50/45 Watts	55/45 Watts	75/65 Watts			
<b>STRW 065</b>	<b>050</b>	<b>06</b>	181	238	265	533	8	0.3	STRW 065 050 06 XXX
		<b>11</b>	245	327	367	772	9	0.7	STRW 065 050 11 XXX
		<b>16</b>	336	452	508	1087	11	1.0	STRW 065 050 16 XXX
		<b>21</b>	458	620	699	1515	13	1.3	STRW 065 050 21 XXX
<b>060</b>	<b>06</b>	<b>06</b>	218	286	319	640	9	0.4	STRW 065 060 06 XXX
		<b>11</b>	294	393	441	926	10	0.8	STRW 065 060 11 XXX
		<b>16</b>	403	542	610	1304	13	1.2	STRW 065 060 16 XXX
		<b>21</b>	549	744	839	1818	15	1.6	STRW 065 060 21 XXX
<b>070</b>	<b>06</b>	<b>06</b>	254	333	371	746	10	0.4	STRW 065 070 06 XXX
		<b>11</b>	342	458	514	1080	12	0.9	STRW 065 070 11 XXX
		<b>16</b>	470	632	711	1521	14	1.4	STRW 065 070 16 XXX
		<b>21</b>	641	867	978	2121	16	1.9	STRW 065 070 21 XXX
<b>080</b>	<b>06</b>	<b>06</b>	290	381	425	853	11	0.5	STRW 065 080 06 XXX
		<b>11</b>	391	523	587	1234	13	1.1	STRW 065 080 11 XXX
		<b>16</b>	537	722	813	1738	16	1.6	STRW 065 080 16 XXX
		<b>21</b>	733	991	1118	2424	18	2.1	STRW 065 080 21 XXX
<b>090</b>	<b>06</b>	<b>06</b>	326	428	477	959	12	0.6	STRW 065 090 06 XXX
		<b>11</b>	440	589	661	1389	14	1.2	STRW 065 090 11 XXX
		<b>16</b>	604	813	915	1956	17	1.8	STRW 065 090 16 XXX
		<b>21</b>	824	1115	1258	2727	20	2.4	STRW 065 090 21 XXX
<b>100</b>	<b>06</b>	<b>06</b>	362	476	531	1066	13	0.6	STRW 065 100 06 XXX
		<b>11</b>	489	654	734	1543	15	1.3	STRW 065 100 11 XXX
		<b>16</b>	671	903	1016	2173	19	2.0	STRW 065 100 16 XXX
		<b>21</b>	916	1239	1398	3030	22	2.7	STRW 065 100 21 XXX
<b>110</b>	<b>06</b>	<b>06</b>	399	524	584	1173	14	0.7	STRW 065 110 06 XXX
		<b>11</b>	538	719	807	1697	17	1.5	STRW 065 110 11 XXX
		<b>16</b>	738	993	1118	2390	20	2.2	STRW 065 110 16 XXX
		<b>21</b>	1007	1363	1537	3333	23	2.9	STRW 065 110 21 XXX
<b>120</b>	<b>06</b>	<b>06</b>	435	571	637	1279	15	0.8	STRW 065 120 06 XXX
		<b>11</b>	587	785	881	1852	18	1.6	STRW 065 120 11 XXX
		<b>16</b>	805	1084	1220	2608	22	2.4	STRW 065 120 16 XXX
		<b>21</b>	1099	1487	1677	3636	25	3.2	STRW 065 120 21 XXX
<b>140</b>	<b>06</b>	<b>06</b>	507	666	743	1492	18	0.8	STRW 065 140 06 XXX
		<b>11</b>	685	916	1028	2160	21	1.6	STRW 065 140 11 XXX
		<b>16</b>	939	1264	1423	3042	26	2.4	STRW 065 140 16 XXX
		<b>21</b>	1282	1735	1957	4242	31	3.2	STRW 065 140 21 XXX
<b>160</b>	<b>06</b>	<b>06</b>	580	762	849	1706	20	1.0	STRW 065 160 06 XXX
		<b>11</b>	783	1047	1175	2469	24	2.1	STRW 065 160 11 XXX
		<b>16</b>	1074	1445	1626	3477	28	3.2	STRW 065 160 16 XXX
		<b>21</b>	1465	1983	2236	4848	33	4.3	STRW 065 160 21 XXX
<b>180</b>	<b>06</b>	<b>06</b>	652	857	955	1919	22	1.2	STRW 065 180 06 XXX
		<b>11</b>	881	1177	1321	2777	26	2.4	STRW 065 180 11 XXX
		<b>16</b>	1208	1626	1829	3911	31	3.6	STRW 065 180 16 XXX
		<b>21</b>	1648	2231	2516	5454	37	4.8	STRW 065 180 21 XXX
<b>200</b>	<b>06</b>	<b>06</b>	725	952	1061	2132	24	1.3	STRW 065 200 06 XXX
		<b>11</b>	979	1308	1468	3086	29	2.7	STRW 065 200 11 XXX
		<b>16</b>	1342	1806	2033	4346	34	4.0	STRW 065 200 16 XXX
		<b>21</b>	1832	2478	2795	6060	40	5.3	STRW 065 200 21 XXX
<b>220</b>	<b>06</b>	<b>06</b>	766	1016	1137	2345	1.4		STRW 065 220 06 XXX
		<b>11</b>	1110	1484	1665	3498	2.9		STRW 065 220 11 XXX
		<b>16</b>	1533	2064	2323	4972	4.4		STRW 065 220 16 XXX
		<b>21</b>	2106	2852	3217	6989	5.9		STRW 065 220 21 XXX
<b>240</b>	<b>06</b>	<b>06</b>	870	1142	1273	2558	29	1.5	STRW 065 240 06 XXX
		<b>11</b>	1174	1570	1762	3703	34	3.2	STRW 065 240 11 XXX
		<b>16</b>	1611	2168	2439	5215	40	4.8	STRW 065 240 16 XXX
		<b>21</b>	2198	2974	3355	7272	48	6.4	STRW 065 240 21 XXX
<b>260</b>	<b>06</b>	<b>06</b>	905	1201	1344	2772	1.7		STRW 065 260 06 XXX
		<b>11</b>	1312	1753	1968	4134	3.5		STRW 065 260 11 XXX
		<b>16</b>	1812	2439	2746	5876	5.1		STRW 065 260 16 XXX
		<b>21</b>	2488	3370	3802	8260	6.9		STRW 065 260 21 XXX
<b>280</b>	<b>06</b>	<b>06</b>	1015	1333	1486	2985	33	1.8	STRW 065 280 06 XXX
		<b>11</b>	1370	1831	2056	4320	39	3.7	STRW 065 280 11 XXX
		<b>16</b>	1879	2529	2846	6084	46	5.5	STRW 065 280 16 XXX
		<b>21</b>	2564	3470	3914	8484	55	7.4	STRW 065 280 21 XXX

Émission EN442 à 20°C

remplir code de couleur



# STRADA

# HAUTEUR 095 (STANDARD)

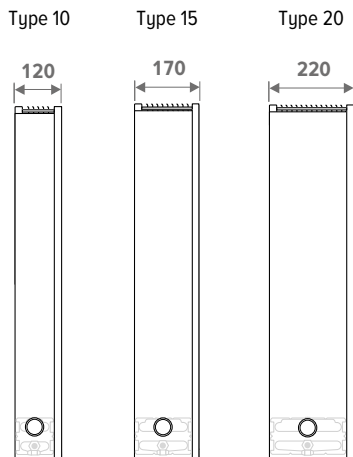

HAUTEUR H cm	LONGUEUR L cm	TYPE T	CHAUFFER Temperature ambiante 20°C				POIDS kg	CONTENU EN EAU L	CODE DE COMMANDE
			45/40 Watts	50/45 Watts	55/45 Watts	75/65 Watts			
STRW 095	050	---	---	---	---	---	---	---	---
		10	---	---	---	---	---	---	---
		15	---	---	---	---	---	---	---
		20	---	---	---	---	---	---	---
	060	---	---	---	---	---	---	---	---
		10	286	375	418	836	14	0.4	STRW 095 060 10 XXX
		15	448	586	651	1288	17	0.6	STRW 095 060 15 XXX
		20	625	816	907	1795	19	0.8	STRW 095 060 20 XXX
	070	---	---	---	---	---	---	---	---
		10	333	437	487	975	16	0.5	STRW 095 070 10 XXX
		15	523	683	759	1502	18	0.7	STRW 095 070 15 XXX
		20	729	952	1058	2094	21	0.9	STRW 095 070 20 XXX
080	---	---	---	---	---	---	---	---	
	10	381	499	556	1114	17	0.5	STRW 095 080 10 XXX	
	15	598	781	868	1717	20	0.8	STRW 095 080 15 XXX	
	20	834	1088	1210	2394	23	1.1	STRW 095 080 20 XXX	
090	---	---	---	---	---	---	---	---	
	10	429	562	626	1254	18	0.6	STRW 095 090 10 XXX	
	15	672	878	976	1931	21	0.9	STRW 095 090 15 XXX	
	20	938	1224	1361	2693	24	1.2	STRW 095 090 20 XXX	
100	---	---	---	---	---	---	---	---	
	10	476	625	696	1393	20	0.7	STRW 095 100 10 XXX	
	15	747	976	1085	2146	23	1.0	STRW 095 100 15 XXX	
	20	1042	1360	1512	2992	26	1.3	STRW 095 100 20 XXX	
110	---	---	---	---	---	---	---	---	
	10	524	687	765	1532	21	0.7	STRW 095 110 10 XXX	
	15	822	1073	1193	2361	25	1.1	STRW 095 110 15 XXX	
	20	1146	1496	1664	3291	28	1.5	STRW 095 110 20 XXX	
120	---	---	---	---	---	---	---	---	
	10	572	750	835	1672	25	0.8	STRW 095 120 10 XXX	
	15	897	1171	1302	2575	29	1.2	STRW 095 120 15 XXX	
	20	1250	1632	1815	3590	33	1.6	STRW 095 120 20 XXX	
140	---	---	---	---	---	---	---	---	
	10	667	874	974	1950	25	0.8	STRW 095 140 10 XXX	
	15	1046	1366	1518	3004	29	1.2	STRW 095 140 15 XXX	
	20	1458	1904	2117	4189	33	1.6	STRW 095 140 20 XXX	

Émission EN442 à 20°C

remplir code de couleur

# STRADA

# HAUTEUR 095 (TWIN)

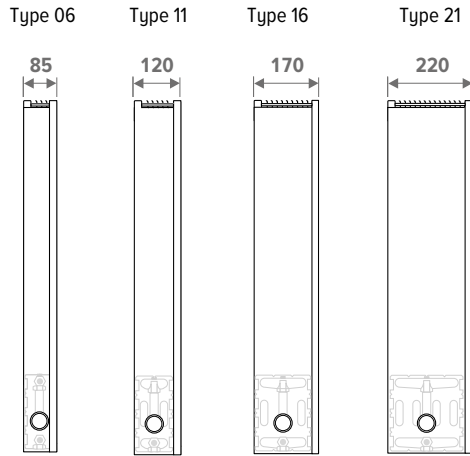

HAUTEUR H cm	LONGUEUR L cm	TYPE T	CHAUFFEUR Température ambiante 20°C				POIDS kg	CONTENU EN EAU L	CODE DE COMMANDE
			45/40 Watts	50/45 Watts	55/45 Watts	75/65 Watts			
<b>STRW 095</b>	<b>050</b>	<b>06</b>	---	---	---	---	---	---	---
		<b>11</b>	---	---	---	---	---	---	
		<b>16</b>	---	---	---	---	---	---	
		<b>21</b>	---	---	---	---	---	---	
<b>060</b>	<b>06</b>	<b>06</b>	259	337	375	736	12	0.4	STRW 095 060 06 XXX
		<b>11</b>	343	458	514	1078	14	0.8	STRW 095 060 11 XXX
		<b>16</b>	491	663	747	1606	16	1.2	STRW 095 060 16 XXX
		<b>21</b>	697	948	1071	2352	19	1.6	STRW 095 060 21 XXX
<b>070</b>	<b>06</b>	<b>06</b>	302	393	437	858	13	0.4	STRW 095 070 06 XXX
		<b>11</b>	400	534	599	1257	15	0.9	STRW 095 070 11 XXX
		<b>16</b>	573	773	871	1874	18	1.4	STRW 095 070 16 XXX
		<b>21</b>	813	1106	1250	2744	21	1.9	STRW 095 070 21 XXX
<b>080</b>	<b>06</b>	<b>06</b>	345	449	499	981	14	0.5	STRW 095 080 06 XXX
		<b>11</b>	457	610	685	1437	17	1.1	STRW 095 080 11 XXX
		<b>16</b>	655	884	996	2142	20	1.6	STRW 095 080 16 XXX
		<b>21</b>	929	1264	1428	3136	23	2.1	STRW 095 080 21 XXX
<b>090</b>	<b>06</b>	<b>06</b>	388	505	561	1103	16	0.6	STRW 095 090 06 XXX
		<b>11</b>	514	686	770	1616	18	1.2	STRW 095 090 11 XXX
		<b>16</b>	737	994	1120	2409	22	1.8	STRW 095 090 16 XXX
		<b>21</b>	1045	1421	1607	3528	25	2.4	STRW 095 090 21 XXX
<b>100</b>	<b>06</b>	<b>06</b>	431	562	624	1226	17	0.6	STRW 095 100 06 XXX
		<b>11</b>	571	763	856	1796	20	1.3	STRW 095 100 11 XXX
		<b>16</b>	819	1105	1244	2677	24	2.0	STRW 095 100 16 XXX
		<b>21</b>	1161	1579	1785	3920	27	2.7	STRW 095 100 21 XXX
<b>110</b>	<b>06</b>	<b>06</b>	475	618	686	1349	18	0.7	STRW 095 110 06 XXX
		<b>11</b>	628	839	942	1976	22	1.5	STRW 095 110 11 XXX
		<b>16</b>	901	1215	1369	2945	25	2.2	STRW 095 110 16 XXX
		<b>21</b>	1277	1737	1964	4312	29	2.9	STRW 095 110 21 XXX
<b>120</b>	<b>06</b>	<b>06</b>	518	674	749	1471	20	0.8	STRW 095 120 06 XXX
		<b>11</b>	685	915	1027	2155	23	1.6	STRW 095 120 11 XXX
		<b>16</b>	982	1325	1493	3212	27	2.4	STRW 095 120 16 XXX
		<b>21</b>	1394	1895	2142	4704	31	3.2	STRW 095 120 21 XXX
<b>140</b>	<b>06</b>	<b>06</b>	604	786	873	1716	23	0.8	STRW 095 140 06 XXX
		<b>11</b>	799	1068	1198	2514	27	1.6	STRW 095 140 11 XXX
		<b>16</b>	1146	1547	1742	3748	33	2.4	STRW 095 140 16 XXX
		<b>21</b>	1626	2211	2499	5488	38	3.2	STRW 095 140 21 XXX

Émission EN442 à 20°C

remplir code de couleur

# STRADA

# PIÈCES DÉTACHÉES

## HABILLAG



### LIVRAISON STANDARD:

- grille
- panneau frontal
- 2 côtés
- Barre arrière
- plaques de recouvrement
- couleur 133, 001 ou 145

### CODE DE COMMANDE

CSTW 020 050 06 XXX

└─ Couleur  
└─ Type  
└─ Longueur  
└─ Hauteur

## KIT DE CHAUFFAGE



### LIVRAISON STANDARD:

- échangeur de chaleur
- supports muraux
- purgeur coudé 1/8" (Hauteur 020) ou Purgeur rallongé 1/8"
- kit de fixation
- bouchon purgeur 1/2"

### CODE DE COMMANDE

HSTW 020 050 06

└─ Type  
└─ Longueur  
└─ Hauteur

## GRILLE



### LIVRAISON STANDARD:

- couleur 133, 001 ou 145

### CODE DE COMMANDE

5621 000 050 06 XXX

└─ Couleur  
└─ Type  
└─ Longueur

## BARRE ARRIÈRE

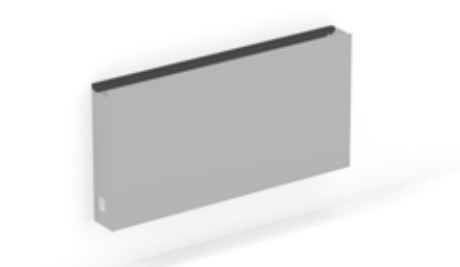

### LIVRAISON STANDARD:

- couleur 133, 001 ou 145

### CODE DE COMMANDE

5521 000 050 00 XXX

└─ Couleur  
└─ Longueur

## PANNEAU FRONTAL

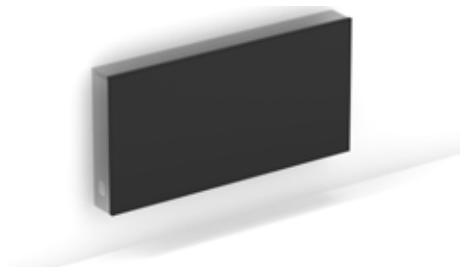

### LIVRAISON STANDARD:

- couleur 133, 001 ou 145

### CODE DE COMMANDE

5503 020 050 00 XXX

└─ Couleur  
└─ Longueur  
└─ Hauteur

## CÔTÉS (par paires)



### LIVRAISON STANDARD:

- couleur 133, 001 ou 145

### CODE DE COMMANDE

5271 020 000 06 XXX

└─ Couleur  
└─ Type  
└─ Hauteur

# STRADA

# PIÈCES DÉTACHÉES

PLAQUE DE RECOUVREMENT (argent)



CODE DE COMMANDE

22165 000 400 11

PLAQUE DE RECOUVREMENT (blanc)



CODE DE COMMANDE

22165 000 400 12

KIT DE FIXATION POUR BARRE ARRIÈRE (par paires)



CODE DE COMMANDE

5521 011

CONSOLES (par pièce)



nombre de supports pour échangeur de chaleur

- de 050 à 110 cm de long : 2 pièces
- de 120 à 220 cm de long : 3 pièces
- de 240 à 280 cm de long : 4 pièces

CODE DE COMMANDE

5121 020 000 06

Type d'échangeur de chaleur  
Hauteur

ÉCHANGEUR DE CHALEUR



LIVRAISON STANDARD:











- échangeur de chaleur
- incl. purgeur d'air perpendiculaire et bouchon purgeur

CODE DE COMMANDE

5003 000 050 06

Type d'échangeur de chaleur  
Longueur

Aperçu des types d'échangeurs de chaleur

	Strada Type 06	Strada Type 10	Strada Type 11	Strada Type 15	Strada Type 16	Strada Type 20	Strada Type 21
<b>Hauteur 020</b>	 Type 07	 Type 10		 Type 15		 Type 20	
<b>Hauteur 035</b> <b>Hauteur 050</b> <b>Hauteur 065</b> <b>Hauteur 095</b>	 Type 08	 Type 10	 Type 11	 Type 15	 Type 16	 Type 20	 Type 21

PURGEUR RALLONGÉ 1/8"



CODE DE COMMANDE	H20				H35					H50					H65					H95						
	Type	06	10	15	20	06	10	11	15	16	20	21	06	10	11	15	16	20	21	06	10	11	15	16	20	21
50900 114 078	-	✓	✓	✓	✓	-	✓	-	✓	-	✓	-	-	-	-	-	-	-	-	-	-	-	-	-	-	-
50900 114 178	-	-	-	-	-	✓	-	✓	-	✓	-	-	-	-	-	-	-	-	-	-	-	-	-	-	-	-
50900 114 278	-	-	-	-	-	-	-	-	-	-	-	✓	-	✓	-	✓	-	✓	-	✓	-	-	-	-	-	-
50900 114 378	-	-	-	-	-	-	-	-	-	-	-	✓	-	✓	-	✓	-	✓	-	✓	-	-	-	-	-	-
50900 114 528	-	-	-	-	-	-	-	-	-	-	-	-	✓	-	✓	-	✓	-	✓	-	-	-	-	-	-	-
50900 114 728	-	-	-	-	-	-	-	-	-	-	-	-	-	-	-	-	-	-	-	✓	✓	✓	✓	✓	✓	✓

Les puissances données à  $\Delta T$  50 sont des valeurs exactes calculées selon EN442. Pour tous les autres  $\Delta T$ , ce tableau donne une valeur calculée en utilisant un facteur de correction moyen valable pour toutes les dimensions.

Sur [www.jaga.com/selection-tools/](http://www.jaga.com/selection-tools/), vous pouvez télécharger des outils de calcul avec les rendements exacts. Les outils de calcul en ligne sont toujours actualisés avec les données les plus récentes. Des différences mineures de rendement entre les tableaux déjà imprimés et les différents outils de calcul en ligne sont donc tout à fait normales et s'inscrivent dans les marges de tolérance fixées par la norme.

#### FACTEURS DE CORRECTION MOYENS POUR LES PRODUITS STATIQUES SELON EN442 - 75/65/20°C

température ambiante: 20°C										température ambiante: 24°C									
Valeur N moyenne : 1.36										Valeur N moyenne : 1.36									
TR	65	60	55	50	45	40	35	30	25	TR	65	60	55	50	45	40	35	30	25
TA										TA									
75	1.00	0.93	0.85	0.77	0.69	0.61	0.52	0.42	0.31	75	0.89	0.82	0.75	0.67	0.59	0.51	0.41	0.31	0.16
70	0.94	0.87	0.79	0.72	0.64	0.56	0.48	0.39	0.28	70	0.83	0.76	0.69	0.62	0.54	0.47	0.38	0.28	0.14
65		0.80	0.74	0.67	0.60	0.52	0.44	0.35	0.25	65		0.70	0.64	0.57	0.50	0.43	0.35	0.25	0.12
60			0.68	0.61	0.55	0.48	0.40	0.32	0.23	60			0.58	0.52	0.45	0.38	0.31	0.23	0.11
55				0.56	0.50	0.43	0.36	0.29	0.20	55				0.47	0.41	0.34	0.28	0.20	0.09
50					0.44	0.38	0.32	0.25	0.18	50					0.36	0.30	0.24	0.17	0.08
45						0.34	0.28	0.22	0.15	45						0.26	0.20	0.14	0.06
40							0.24	0.19	0.13	40							0.17	0.12	0.05
35								0.15	0.10	35								0.09	0.03
30									0.07	30									0.02

Facteurs de correction moyens pour Strada (sans DBH). Facteurs de correction exacts pour Strada ou Strada Hybrid : voir les outils de sélection

#### DIRECTIVE POUR LIMITER LES BRUITS D'ÉCOULEMENT

TUYAU	Ø extérieur mm	Épais- seur de la paroi mm	Vitesse max. de l'eau (EN10255) m/s	teneur en eau par mètre l	débit d'eau max. kg/h	Puissance maximale à $\Delta T$ (°C) (T alimentation - T retour)						
						$\Delta T$ 30 Watts	$\Delta T$ 20 Watts	$\Delta T$ 10 Watts	$\Delta T$ 5 Watts	$\Delta T$ 4 Watts	$\Delta T$ 3 Watts	$\Delta T$ 2 Watts
<b>TUBE GALVANISÉ DIN 2440</b>												
3/8 DN10 OD	17.2	2.35	0.40	0.12	173	6028	4019	2009	1005	804	603	402
1/2 DN15 OD	21.3	2.65	0.40	0.20	288	10046	6698	3349	1674	1340	1005	670
3/4 DN20 OD	26.9	2.65	0.42	0.37	559	19515	13010	6505	3253	2602	1952	1301
1 DN25 OD	33.7	3.25	0.49	0.58	1023	35690	23793	11897	5948	4759	3569	2379
1 1/4 DN32 OD	42.4	3.25	0.60	1.01	2182	76101	50734	25367	12684	10147	7610	5073
1 1/2 DN40 OD	48.3	3.25	0.66	1.37	3255	113549	75700	37850	18925	15140	11355	7570
2 DN50 OD	60.3	3.65	0.80	2.21	6365	222025	148017	74008	37004	29603	22203	14802
<b>TUBE MÉTALLIQUE DE PRÉCISION</b>												
10/1	10	1.00	0.40	0.05	72	2512	1674	837	419	335	251	167
12/1	12	1.00	0.40	0.08	115	4019	2679	1340	670	536	402	268
14/1	14	1.00	0.40	0.11	158	5526	3684	1842	921	737	553	368
15/1	15	1.00	0.40	0.13	187	6530	4353	2177	1088	871	653	435
16/1	16	1.00	0.40	0.15	216	7535	5023	2512	1256	1005	753	502
18/1	18	1.00	0.40	0.20	288	10046	6698	3349	1674	1340	1005	670
22/1	22	1.00	0.40	0.31	446	15572	10381	5191	2595	2076	1557	1038
28/1	28	1.00	0.47	0.53	904	31522	21014	10507	5254	4203	3152	2101
<b>PER/ALU</b>												
12/2	12	2.00	0.40	0.05	72	2512	1674	837	419	335	251	167
14/2	14	2.00	0.40	0.08	115	4019	2679	1340	670	536	402	268
16/1.5	16	1.50	0.40	0.13	187	6530	4353	2177	1088	871	653	435
16/2	16	2.00	0.40	0.11	158	5526	3684	1842	921	737	553	368
17/2	17	2.00	0.40	0.13	187	6530	4353	2177	1088	871	653	435
18/2	18	2.00	0.40	0.15	216	7535	5023	2512	1256	1005	753	502
20/2	20	2.00	0.40	0.20	288	10046	6698	3349	1674	1340	1005	670
26/3	26	3.00	0.40	0.31	446	15572	10381	5191	2595	2076	1557	1038
32/3	32	3.00	0.47	0.53	904	31522	21014	10507	5254	4203	3152	2101
40/3.5	40	3.50	0.56	0.86	1726	60220	40147	20073	10037	8029	6022	4015
50/4.25	50	4.25	0.66	1.35	3206	111824	74549	37275	18637	14910	11182	7455
63/5	63	5.00	0.80	2.21	6346	221359	147573	73786	36893	29515	22136	14757

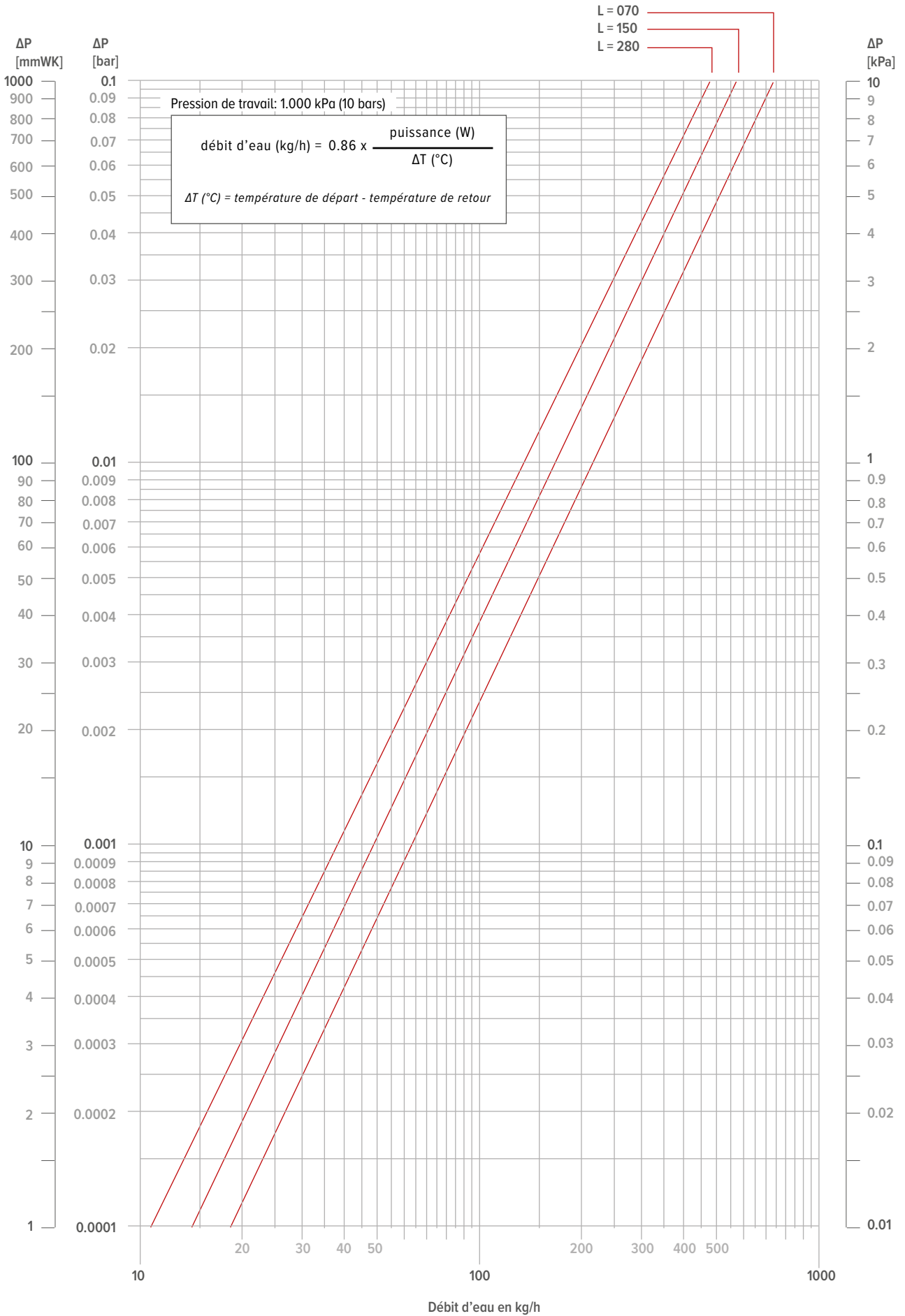

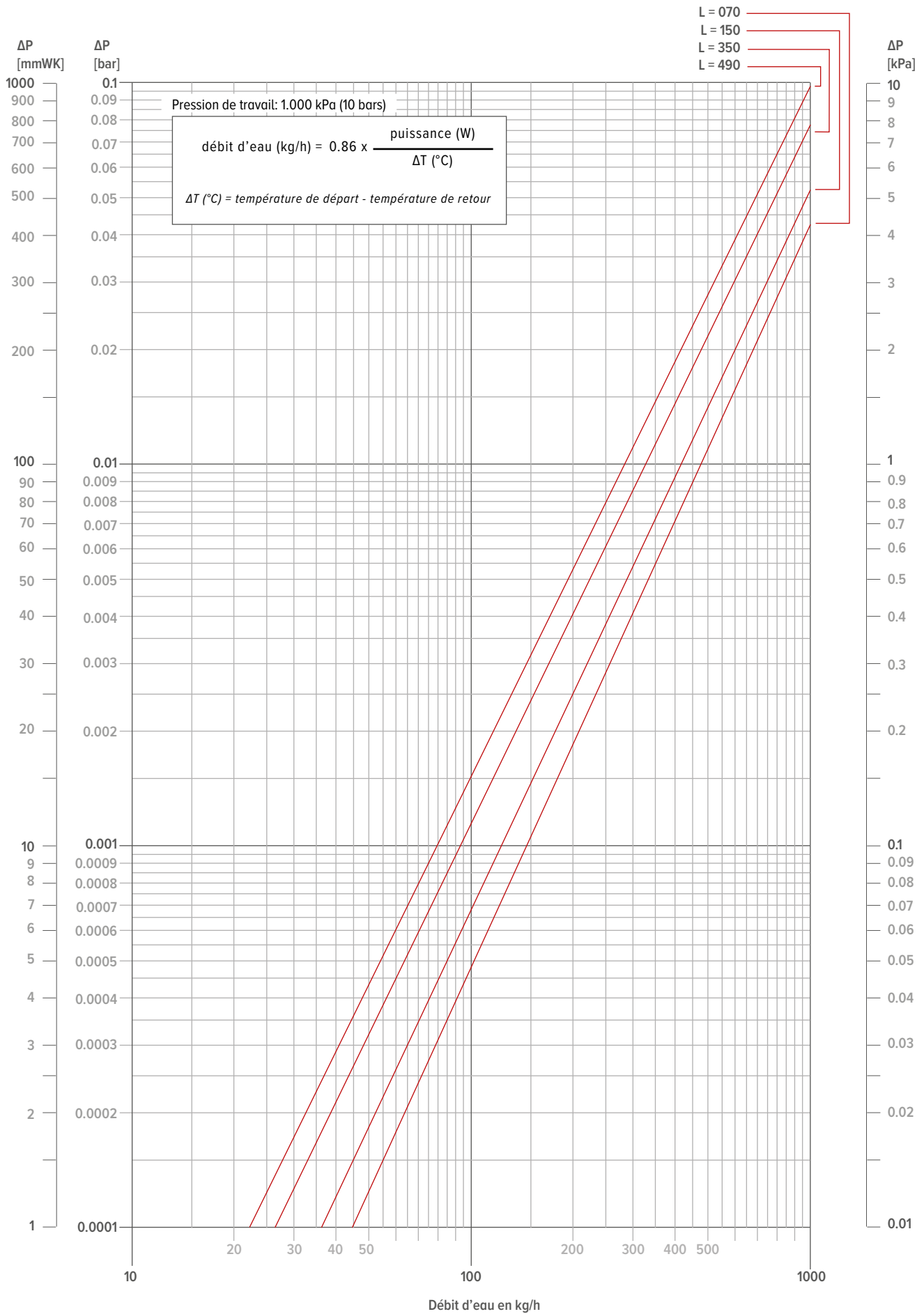



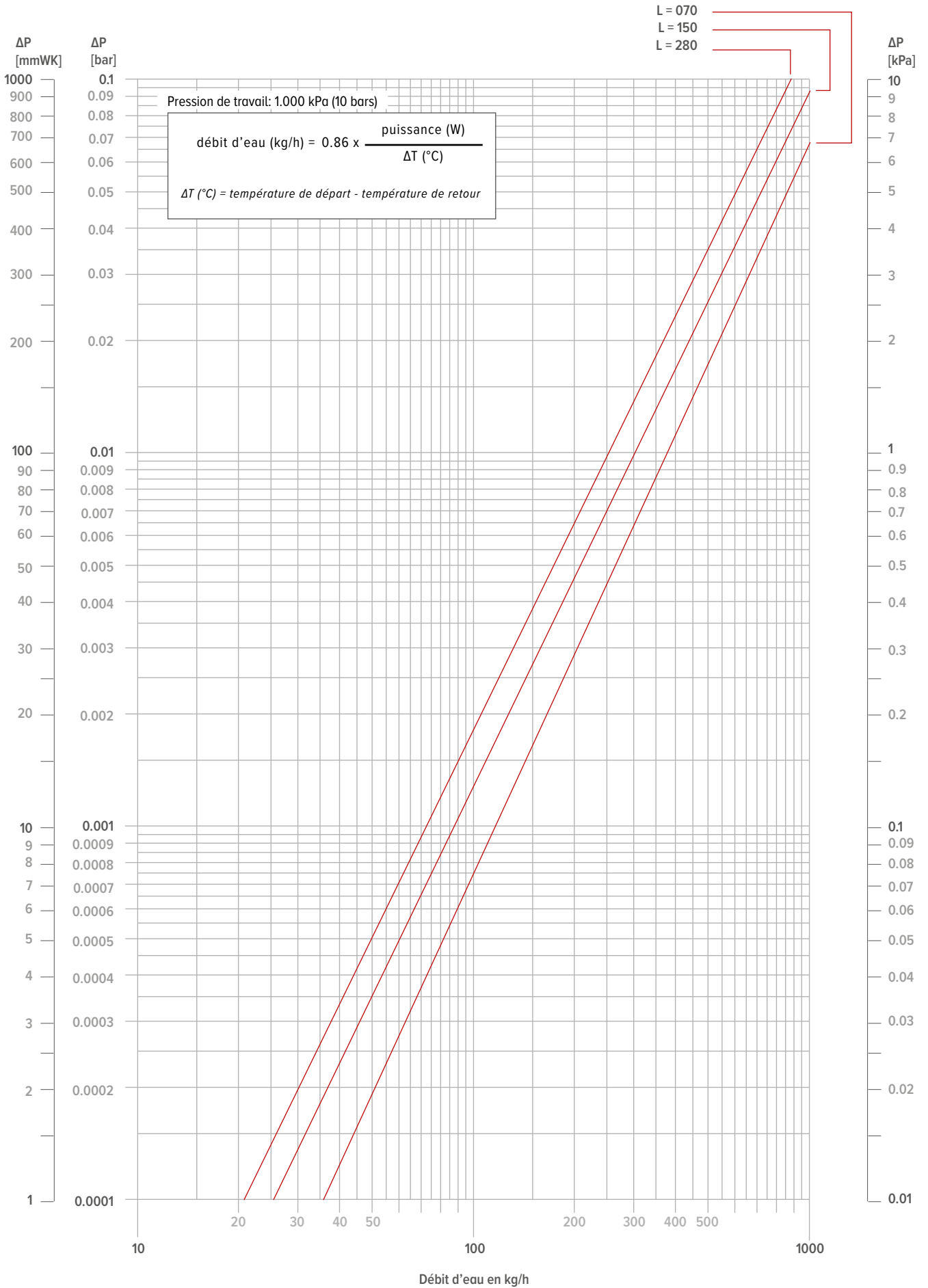

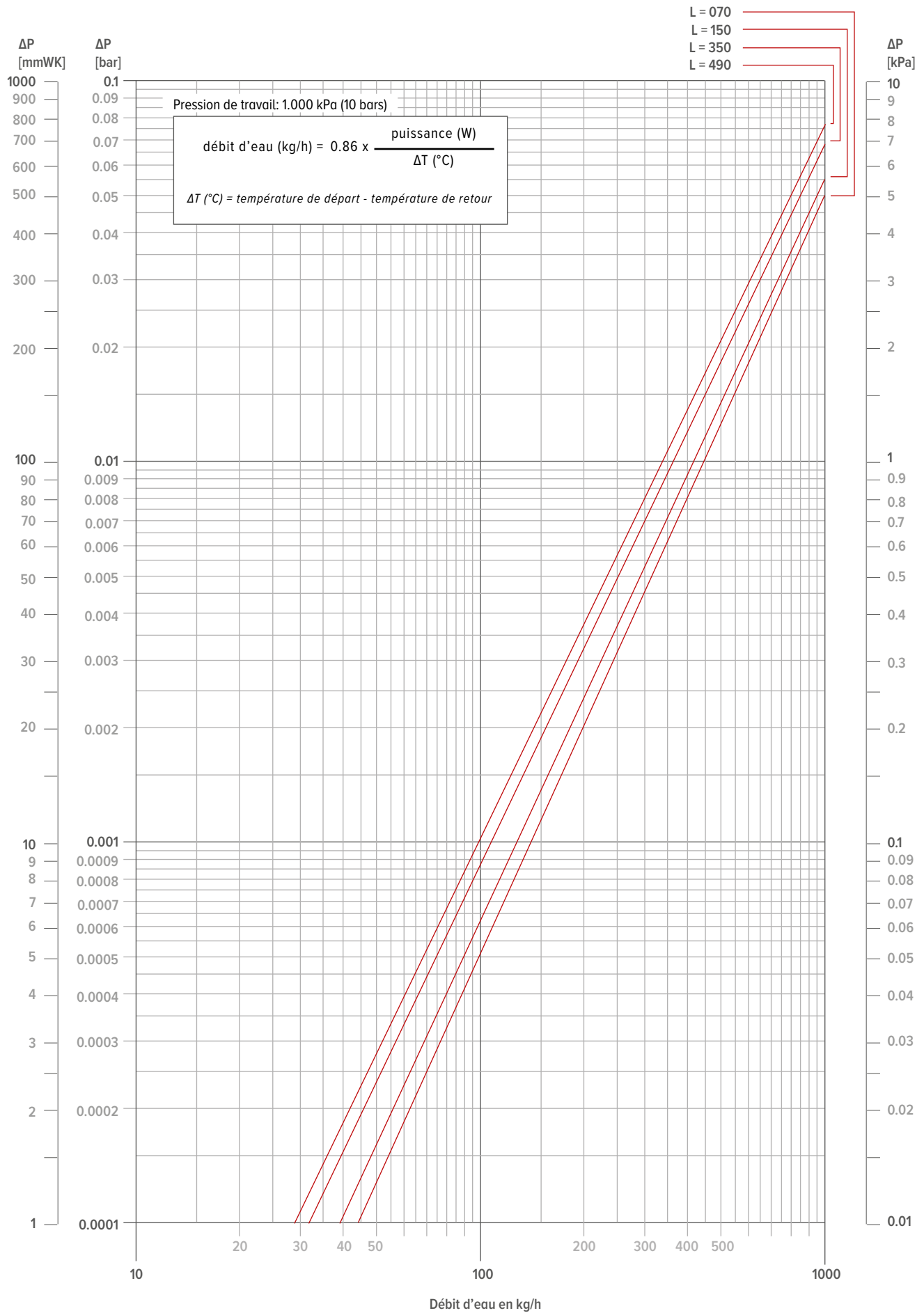

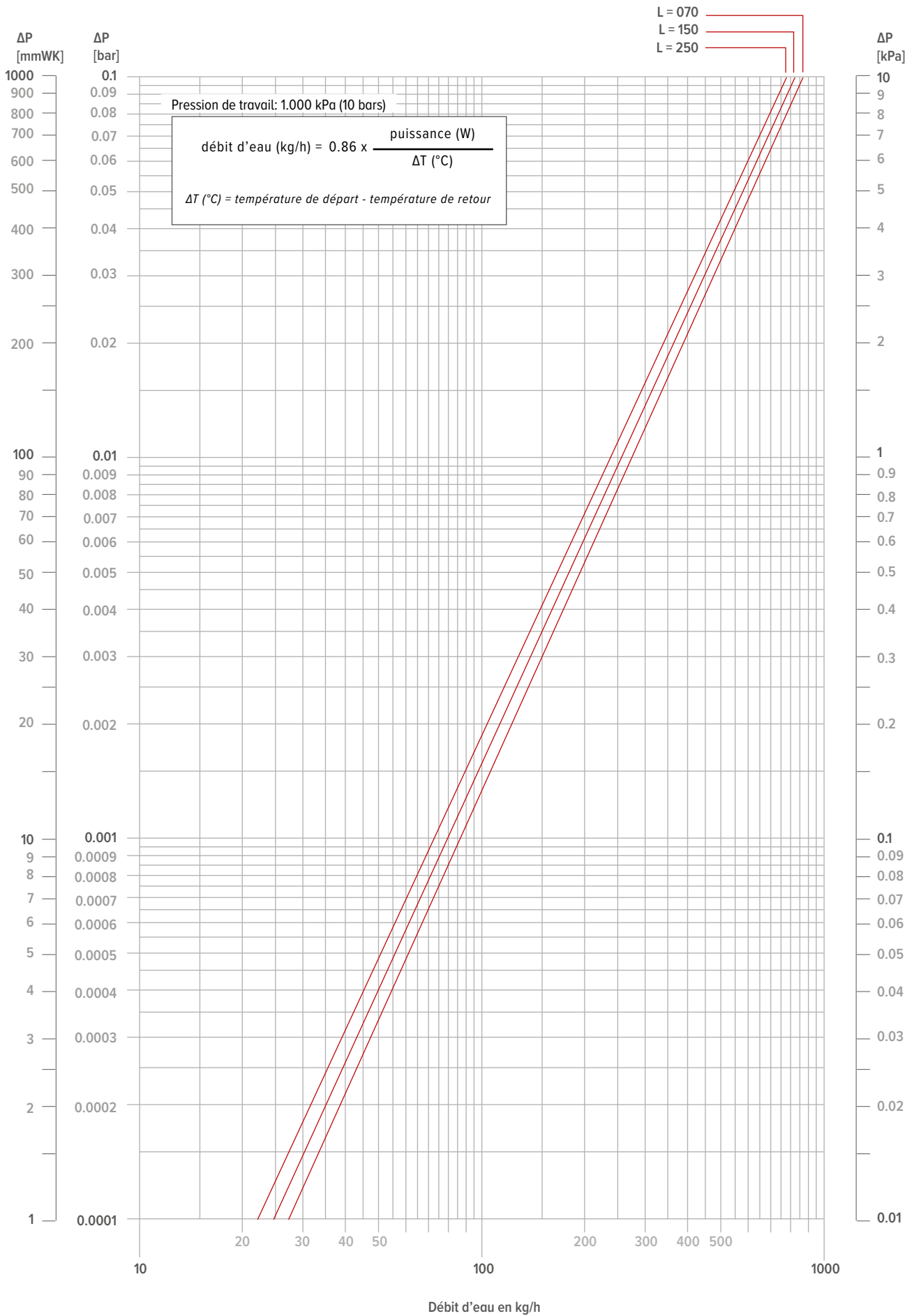

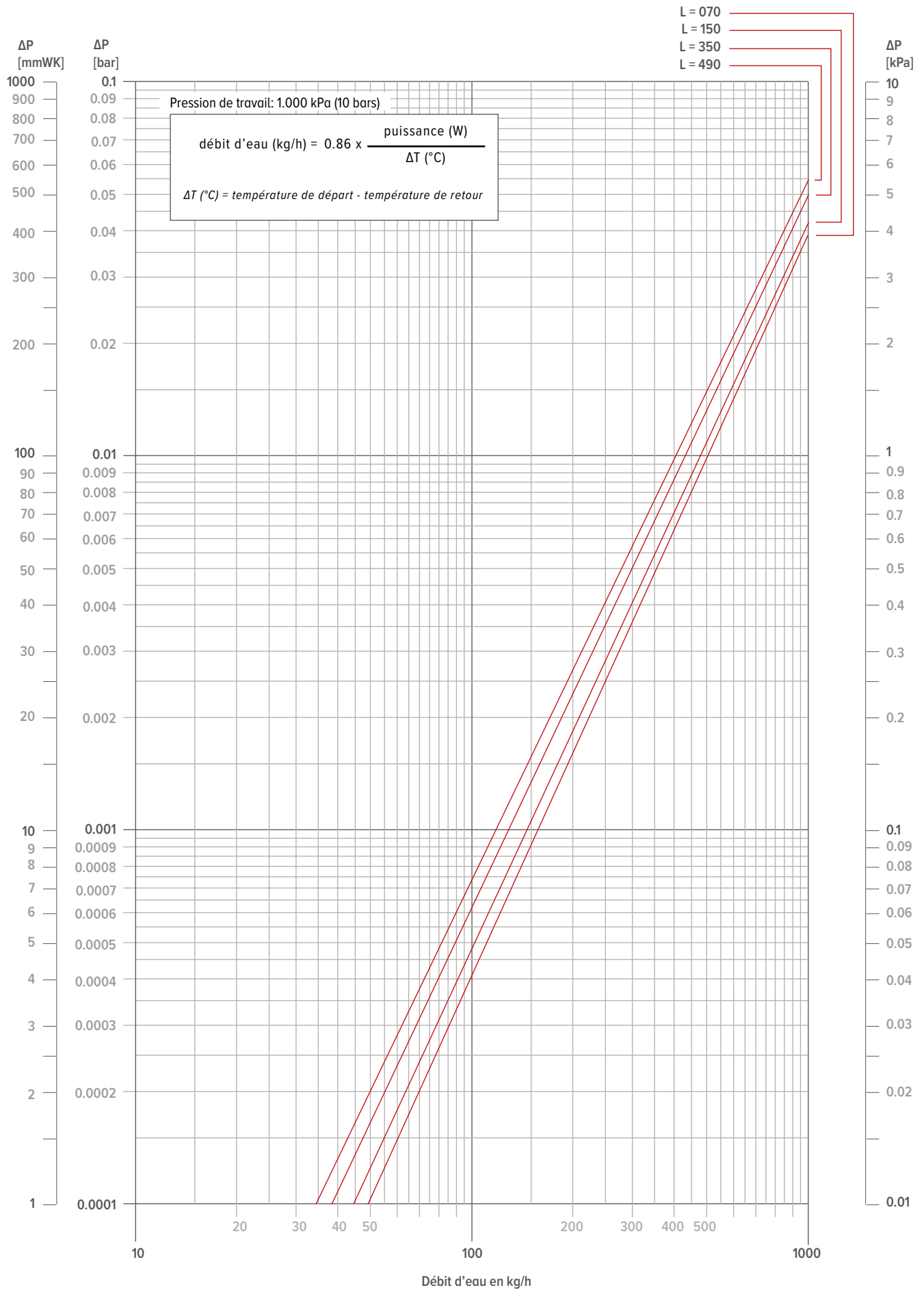

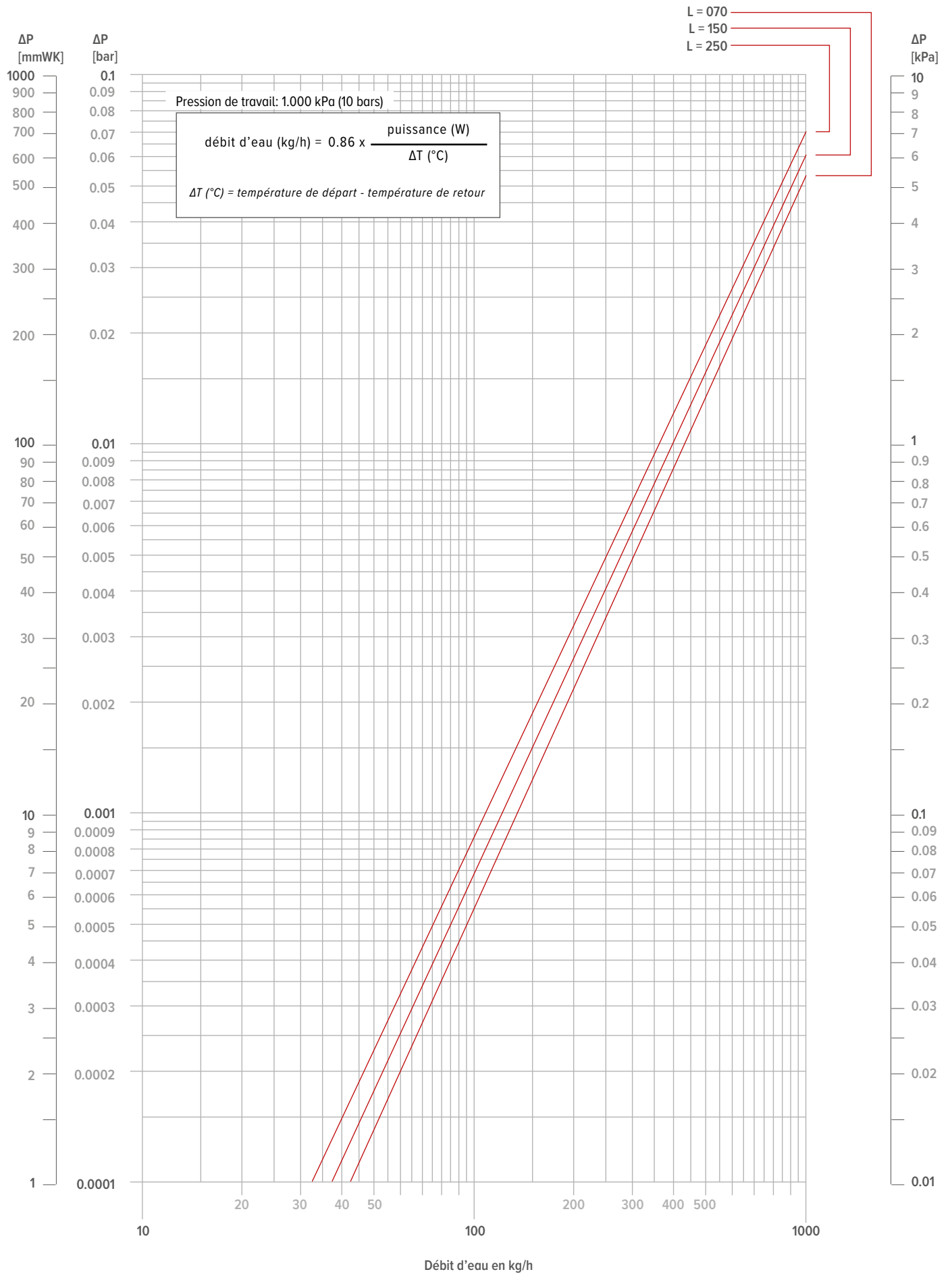



**jaga** CLIMATE  
DESIGNERS

**BELGIQUE JAGA SA**

Besoin d'un conseil ? Prenez rendez-vous au Centre de Conseils Jaga !

Verbindingslaan 16  
3590 Diepenbeek

+32 (0) 11 29 41 11

info@jaga.be  
jaga.com