

jaga

CLIMATE DESIGNERS



STRADA



STRADA HYBRID

Chcete větší výkon při nižších teplotách a/nebo chlazení Light Cooling se Stradou? Potom zvolte Stradu Hybrid



STRADA HYBRID MM

Chcete větší výkon při nižších teplotách a/nebo chlazení Light Cooling se Stradou se středovým připojením? Potom zvolte Stradu Hybrid



DBH UPGRADE SADA

Máte již Stradu a chcete ji upgradovat, abyste získali vyšší výkon při nižších teplotách a/nebo chcete chlazení Light Cooling? Pak se podívejte do naší brožury na DBH Upgrade Sadu.

PŘED

Pouze topení



Strada H50 L100 Typ 11



PO

Topení



+

Breeze



+

Chlazení

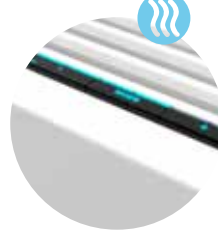

Light cooling pro všechna tepelná čerpadla s funkcí chlazení

Strada H50 L100 Typ 11
+ Sada DBH typ 10



Nacvakněte ventilátorové jednotky

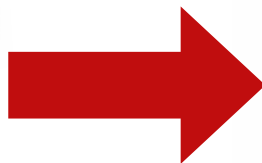

STRADA

OBSAH	3
TECHNICKÉ INFORMACE	5
Rozměry	5
Volitelný držák ručníku	5
Hydraulické připojení	6
Připojení vlevo nebo vpravo s ovládacími prvky ve spodní části (Standardní)	6
Připojení vlevo nebo vpravo s ovládacími prvky v horní části	6
Připojení vlevo nebo vpravo s dálkovým nastavením	6
Nejpoužívanější připojovací sady	7
Tabulka-technické údaje	8
Výška 020	8
Výška 035	10
Výška 050	12
Výška 065	14
Výška 095	16
Jednotlivé díly	18
Korekční faktory	20
Tlakové ztráty	21
Typ 06	21
Typ 10	22
Typ 11	23
Typ 15	24
Typ 16	25
Typ 20	26
Typ 21	27



ROZMĚRY (v mm)

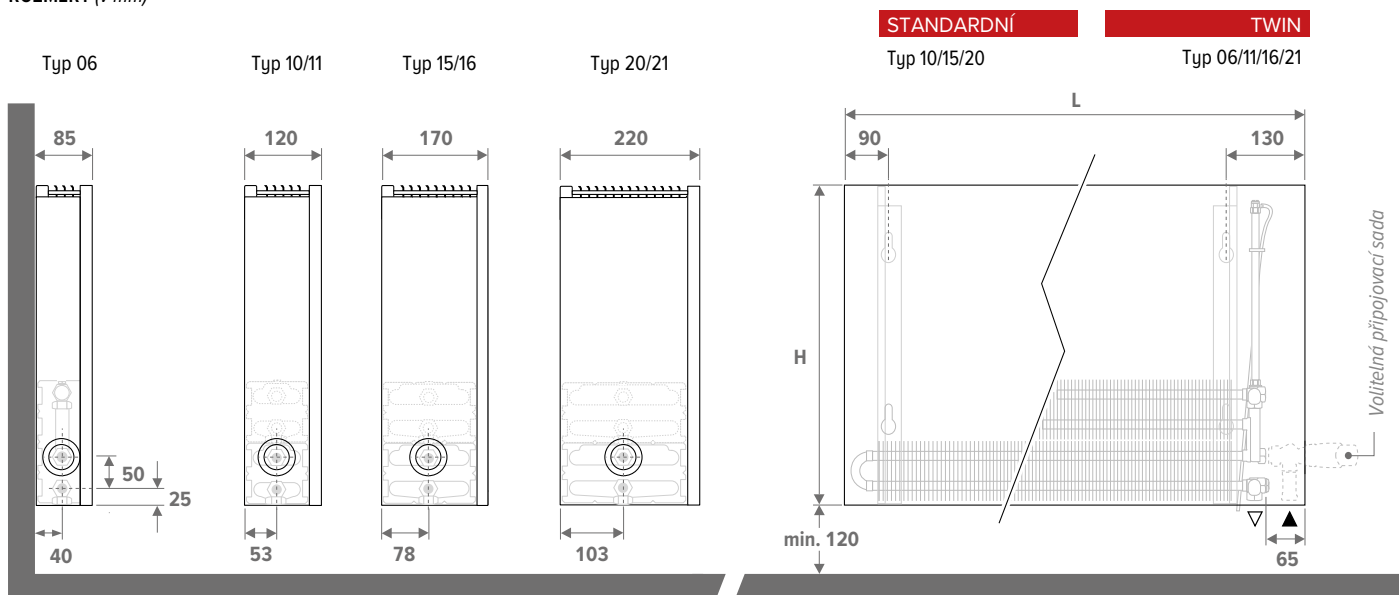

STANDARDNÍ DODÁVKA

- Výměník tepla s nízkým obsahem vody, s povrchem odpuzujícím prach a nečistoty v grafitově šedé barvě (RAL 7024)
- stěnové konzole, montážní sada, rohový odvzdušňovací ventil (výška 020) nebo prodloužený odvzdušňovací ventil 1/8" a výpustná zátka 1/2
- částečně smontovaný kryt pro připojení vlevo nebo vpravo dole
- krycí destička ve vzhledu ušlechtilé oceli pro bočník na protější straně od ventilu

DRŽÁK RUČNÍKU

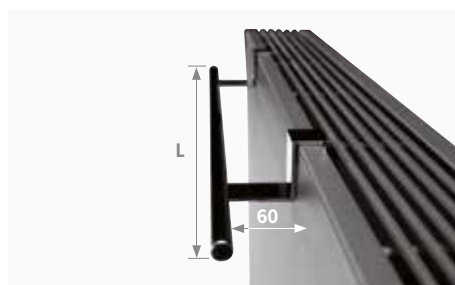

OBJEDNACÍ KÓD

STRW 020 050 06 XXX

Barva
Typ
Délka
Výška

BARVY

Vysoce odolný lak proti oděrkám a UV záření, šetrný k životnímu prostředí

Standardní barvy

- dopravní bílá RAL 9016 (133), jemně strukturovaný povrch
- pískovaně šedá metalíza (001), jemná metalická struktura
- černošedá (145), jemně strukturovaný saténový povrch

Další barvy

viz vzorník barev Jaga.

Příplatek v závislosti na délce jednotky:

- Délka < 100 cm
- Délka 100 cm - 200 cm
- Délka > 200 cm

OBJ. KÓD	L	
5501 001	560	V pochromovaném hliníku
5501 002	660	V pochromovaném hliníku



STANDARDNÍ: PŘIPOJENÍ VLEVO NEBO VPRAVO S OVLÁDACÍMI PRVKY VE SPODNÍ ČÁSTI

Vlevo nebo vpravo dole, ke stěně nebo k podlaze. Připojení ke stěně přes spodní část krytu nebo zcela skryto uvnitř krytu. Výměník tepla lze natočit tak, aby vyhovoval připojení vlevo nebo vpravo.

Možné připojovací sady Eurokonus: 101, 102, 103, 104, 181, 182, 183, 184, 222, 225, 226, 282, 285

Možné připojovací sady M24: 11, 12, 13, 14, 25

Příklad připojení vpravo (standardní)

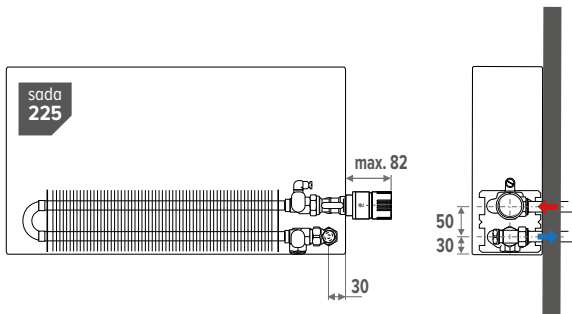

Příklad připojení vlevo

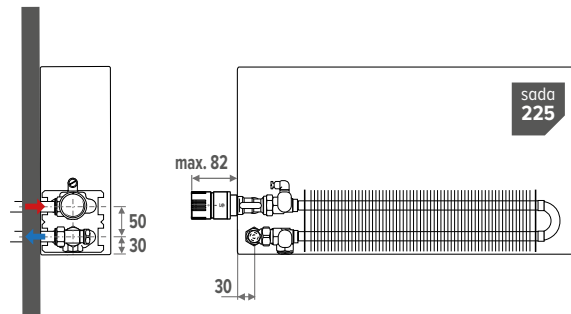

PŘIPOJENÍ VLEVO NEBO VPRAVO S OVLÁDACÍMI PRVKY V HORNÍ ČÁSTI

Připojte ke kódu tělesa označení strany připojení / 30 (vlevo) nebo / 60 (vpravo). PŘ. STRW.035 050 06 XXX 60

Možné připojovací sady Eurokonus: 115, 116, 117, 118

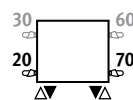

Příklad připojení vpravo (standardní)

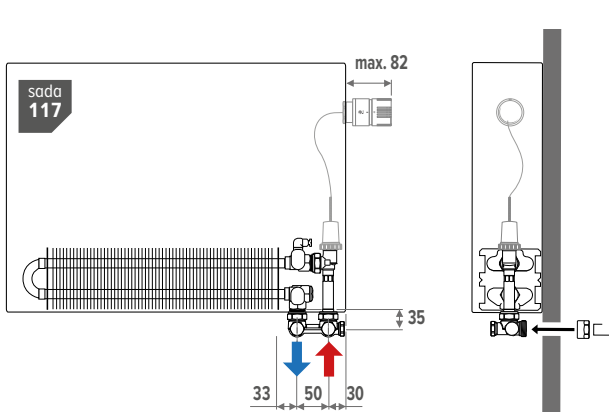

Příklad připojení vlevo

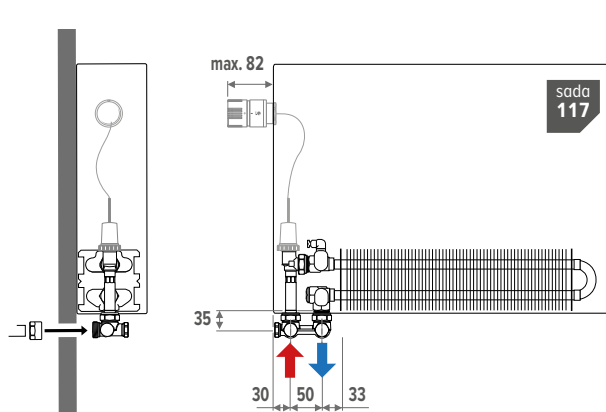

PŘIPOJENÍ VLEVO NEBO VPRAVO S DÁLKOVÝM NASTAVENÍM

Připojte ke kódu tělesa 00 (uzavřené strany) PŘ. STRW.035 050 06 XXX 00

Možné připojovací sady Eurokonus: 111, 112, 113, 114

Možné připojovací sady M24: 28, 29

Příklad připojení vpravo (standardní)

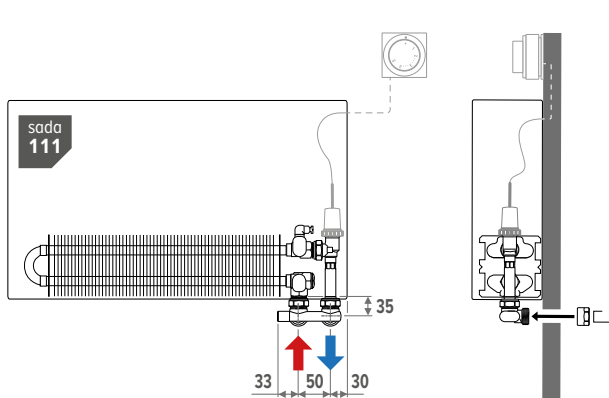

Příklad připojení vlevo

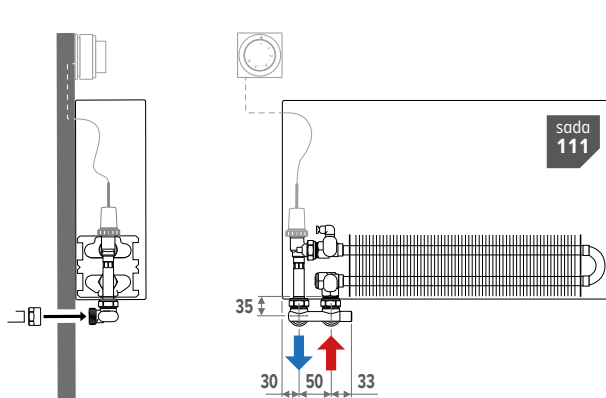

Ke stěně - PŘÍVOD NA VNĚJŠÍ STRANĚ S Jaga H-kusem

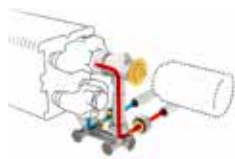

sada 103 KVS: 0.8 DVOUSTRUBKA / JEDNOTRUBKA

COLO HBSW AC 4...	AC	
COLO HBSW AW 4...	AW	
COLO HBSW AS 4...	AS	
COLO HBSW AB 4...	AB	
COLO HBSW JH 4...	JH	

vyplňte kód svěrného šroubení

S dynamickým ventilem Gampper Vario DP



sada 183 automatické omezení průtoku (20 - 340 l/h) DVOUSTRUBKA

COLO GASW AC 4...	AC	
COLO GASW AW 4...	AW	
COLO GASW AS 4...	AS	
COLO GASW AB 4...	AB	
COLO GASW JH 4...	JH	

vyplňte kód svěrného šroubení

K podlaze - PŘÍVOD NA VNĚJŠÍ STRANĚ S Jaga H-kusem



sada 104 KVS: 0.8 DVOUSTRUBKA / JEDNOTRUBKA

COLO HBSF AC 4...	AC	
COLO HBSF AW 4...	AW	
COLO HBSF AS 4...	AS	
COLO HBSF AB 4...	AB	
COLO HBSF JH 4...	JH	

vyplňte kód svěrného šroubení

S dynamickým ventilem Gampper Vario DP

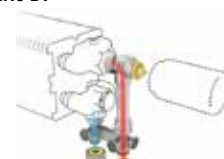

sada 184 automatické omezení průtoku (20 - 340 l/h) DVOUSTRUBKA

COLO GASF AC 4...	AC	
COLO GASF AW 4...	AW	
COLO GASF AS 4...	AS	
COLO GASF AB 4...	AB	
COLO GASF JH 4...	JH	

vyplňte kód svěrného šroubení

Ke stěně - PŘÍVOD NA VNITŘNÍ STRANĚ S Jaga armaturou pro záměnu přívodu a zpátečky

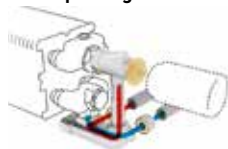

sada 101 KVS: 0.8 DVOUSTRUBKA

COLO HBCW AC 4...	AC	
COLO HBCW AW 4...	AW	
COLO HBCW AS 4...	AS	
COLO HBCW AB 4...	AB	
COLO HBCW JH 4...	JH	

vyplňte kód svěrného šroubení

S dynamickým ventilem Gampper Vario DP

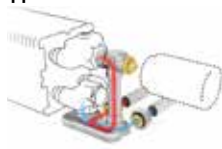

sada 181 automatické omezení průtoku (20 - 340 l/h) DVOUSTRUBKA

COLO GACW AC 4...	AC	
COLO GACW AW 4...	AW	
COLO GACW AS 4...	AS	
COLO GACW AB 4...	AB	
COLO GACW JH 4...	JH	

vyplňte kód svěrného šroubení

K podlaze - PŘÍVOD NA VNITŘNÍ STRANĚ S Jaga armaturou pro záměnu přívodu a zpátečky

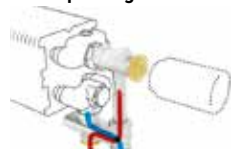

sada 102 KVS: 0.8 DVOUSTRUBKA

COLO HBCF AC 4...	AC	
COLO HBCF AW 4...	AW	
COLO HBCF AS 4...	AS	
COLO HBCF AB 4...	AB	
COLO HBCF JH 4...	JH	

vyplňte kód svěrného šroubení

S dynamickým ventilem Gampper Vario DP

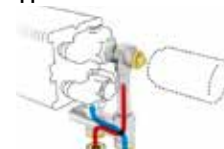

sada 182 automatické omezení průtoku (20 - 340 l/h) DVOUSTRUBKA

COLO GACF AC 4...	AC	
COLO GACF AW 4...	AW	
COLO GACF AS 4...	AS	
COLO GACF AB 4...	AB	
COLO GACF JH 4...	JH	

vyplňte kód svěrného šroubení

Ke stěně - UVNITŘ KRYTU S ventilem Jaga



sada 225 KVS: 0.8 DVOUSTRUBKA

COLO SW2 AC 4...	AC	
COLO SW2 AW 4...	AW	
COLO SW2 AS 4...	AS	
COLO SW2 AB 4...	AB	
COLO SW2 JH 4...	JH	

vyplňte kód svěrného šroubení

S dynamickým ventilem Gampper Vario DP



sada 285 automatické omezení průtoku (20 - 340 l/h) DVOUSTRUBKA

COLO GW2 AC 4...	AC	
COLO GW2 AW 4...	AW	
COLO GW2 AS 4...	AS	
COLO GW2 AB 4...	AB	
COLO GW2 JH 4...	JH	

vyplňte kód svěrného šroubení

Se 2 zpátečkovými šroubeními

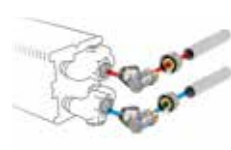

sada 226 DVOUSTRUBKA

COLO LOA 00 4...	AC	
------------------	----	--

vyplňte kód svěrného šroubení

Svěrná šroubení 3/4" na Eurokonus

PRO PŘESNOU OCELOVOU A MĚDĚNOU TRUBKU		PRO PLASTOVOU NEBO VPE/ALU TRUBKU	
KÓD	Trubka Ø	KÓD	Trubka Ø
112	12/1	612	12/2
114	14/1	614	14/2
115	15/1	616	16/2
116	16/1	618	18/2
118	18/1	619	16/1,5
		620	20/2

Strada Typ 06 stěnové připojení uvnitř krytu: sada 25

STRADA

VÝŠKA 020 (STANDARDNÍ)

Typ 10

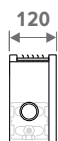

Typ 15

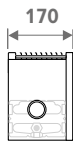

Typ 20

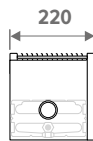

VÝŠKA H cm	DĚLKA L cm	TYP T	TOPENÍ Pokojová teplota 20°C				HMOTNOST kg	OBSAH VODY L	OBJEDNACÍ KÓD
			45/40 Watty	50/45 Watty	55/45 Watty	75/65 Watty			
STRW 020	050	---	---	---	---	---	---	---	
10	106	141	158	328	4	0.3	STRW 020 050 10 XXX		
15	177	235	263	545	5	0.5	STRW 020 050 15 XXX		
20	249	330	370	766	6	0.7	STRW 020 050 20 XXX		
060	---	---	---	---	---	---	---		
10	127	169	189	393	5	0.4	STRW 020 060 10 XXX		
15	212	282	316	654	6	0.6	STRW 020 060 15 XXX		
20	298	396	444	919	7	0.8	STRW 020 060 20 XXX		
070	---	---	---	---	---	---	---		
10	148	197	221	459	5	0.5	STRW 020 070 10 XXX		
15	248	329	369	763	7	0.7	STRW 020 070 15 XXX		
20	348	462	518	1072	8	0.9	STRW 020 070 20 XXX		
080	---	---	---	---	---	---	---		
10	169	225	252	524	6	0.5	STRW 020 080 10 XXX		
15	283	376	421	872	7	0.8	STRW 020 080 15 XXX		
20	398	529	592	1226	9	1.1	STRW 020 080 20 XXX		
090	---	---	---	---	---	---	---		
10	191	254	284	590	6	0.6	STRW 020 090 10 XXX		
15	318	423	474	981	8	0.9	STRW 020 090 15 XXX		
20	448	595	666	1379	10	1.2	STRW 020 090 20 XXX		
100	---	---	---	---	---	---	---		
10	212	282	316	655	7	0.7	STRW 020 100 10 XXX		
15	354	470	526	1090	9	1.0	STRW 020 100 15 XXX		
20	497	661	740	1532	11	1.3	STRW 020 100 20 XXX		
110	---	---	---	---	---	---	---		
10	233	310	347	721	8	0.7	STRW 020 110 10 XXX		
15	389	517	579	1199	10	1.1	STRW 020 110 15 XXX		
20	547	727	814	1685	12	1.5	STRW 020 110 20 XXX		
120	---	---	---	---	---	---	---		
10	254	338	379	786	8	0.8	STRW 020 120 10 XXX		
15	424	564	632	1308	11	1.2	STRW 020 120 15 XXX		
20	596	793	888	1838	13	1.6	STRW 020 120 20 XXX		
140	---	---	---	---	---	---	---		
10	296	394	442	917	10	0.8	STRW 020 140 10 XXX		
15	495	658	737	1526	12	1.2	STRW 020 140 15 XXX		
20	696	925	1036	2145	15	1.6	STRW 020 140 20 XXX		
160	---	---	---	---	---	---	---		
10	339	451	505	1048	11	1.0	STRW 020 160 10 XXX		
15	566	752	842	1744	14	1.6	STRW 020 160 15 XXX		
20	795	1057	1184	2451	17	2.1	STRW 020 160 20 XXX		
180	---	---	---	---	---	---	---		
10	381	507	568	1179	12	1.2	STRW 020 180 10 XXX		
15	637	846	948	1962	15	1.8	STRW 020 180 15 XXX		
20	895	1190	1332	2758	19	2.4	STRW 020 180 20 XXX		
200	---	---	---	---	---	---	---		
10	423	563	631	1310	13	1.3	STRW 020 200 10 XXX		
15	707	940	1053	2180	17	2.0	STRW 020 200 15 XXX		
20	994	1322	1480	3064	21	2.6	STRW 020 200 20 XXX		
220	---	---	---	---	---	---	---		
10	466	620	694	1441	14	1.4	STRW 020 220 10 XXX		
15	778	1034	1158	2398	2.2	2.2	STRW 020 220 15 XXX		
20	1094	1454	1628	3370	2.9	2.9	STRW 020 220 20 XXX		
240	---	---	---	---	---	---	---		
10	508	676	757	1572	16	1.6	STRW 020 240 10 XXX		
15	849	1128	1264	2616	20	2.4	STRW 020 240 15 XXX		
20	1193	1586	1776	3677	25	3.2	STRW 020 240 20 XXX		
260	---	---	---	---	---	---	---		
10	550	732	820	1703	1.7	1.7	STRW 020 260 10 XXX		
15	920	1222	1369	2834	2.5	2.5	STRW 020 260 15 XXX		
20	1293	1718	1924	3983	3.4	3.4	STRW 020 260 20 XXX		
280	---	---	---	---	---	---	---		
10	593	789	884	1834	19	1.8	STRW 020 280 10 XXX		
15	990	1316	1474	3052	24	2.7	STRW 020 280 15 XXX		
20	1392	1850	2072	4290	29	3.7	STRW 020 280 20 XXX		

Výkony měřeny podle EN442 při 20°C

vyplňte kód barvy

Typ 06

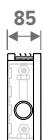

VÝŠKA H cm	DĚLKA L cm	TYP T	TOPENÍ Pokojová teplota 20°C				HMOTNOST OBSAH VODY		OBJEDNACÍ KÓD
			45/40 Watty	50/45 Watty	55/45 Watty	75/65 Watty	kg	L	
STRW 020	050	06	87	116	130	269	4	0.3	STRW 020 050 06 XXX
		11	---	---	---	---	---	---	
		16	---	---	---	---	---	---	
		21	---	---	---	---	---	---	
	060	06	105	139	156	323	4	0.4	STRW 020 060 06 XXX
		11	---	---	---	---	---	---	
		16	---	---	---	---	---	---	
		21	---	---	---	---	---	---	
	070	06	122	162	182	377	5	0.4	STRW 020 070 06 XXX
		11	---	---	---	---	---	---	
		16	---	---	---	---	---	---	
		21	---	---	---	---	---	---	
080	06	139	185	207	430	5	0.5	STRW 020 080 06 XXX	
	11	---	---	---	---	---	---		
	16	---	---	---	---	---	---		
	21	---	---	---	---	---	---		
090	06	157	209	234	484	6	0.6	STRW 020 090 06 XXX	
	11	---	---	---	---	---	1.2		
	16	---	---	---	---	---	---		
	21	---	---	---	---	---	---		
100	06	174	232	260	538	6	0.6	STRW 020 100 06 XXX	
	11	---	---	---	---	---	---		
	16	---	---	---	---	---	---		
	21	---	---	---	---	---	---		
110	06	192	255	286	592	7	0.7	STRW 020 110 06 XXX	
	11	---	---	---	---	---	---		
	16	---	---	---	---	---	---		
	21	---	---	---	---	---	---		
120	06	209	278	312	646	7	0.8	STRW 020 120 06 XXX	
	11	---	---	---	---	---	---		
	16	---	---	---	---	---	---		
	21	---	---	---	---	---	---		
140	06	244	324	363	753	8	0.8	STRW 020 140 06 XXX	
	11	---	---	---	---	---	---		
	16	---	---	---	---	---	---		
	21	---	---	---	---	---	---		
160	06	279	371	415	861	10	1.0	STRW 020 160 06 XXX	
	11	---	---	---	---	---	---		
	16	---	---	---	---	---	---		
	21	---	---	---	---	---	---		
180	06	314	417	467	968	11	1.2	STRW 020 180 06 XXX	
	11	---	---	---	---	---	---		
	16	---	---	---	---	---	---		
	21	---	---	---	---	---	---		
200	06	349	464	519	1076	12	1.3	STRW 020 200 06 XXX	
	11	---	---	---	---	---	---		
	16	---	---	---	---	---	---		
	21	---	---	---	---	---	---		
220	06	384	510	571	1184		1.4	STRW 020 220 06 XXX	
	11	---	---	---	---	---	---		
	16	---	---	---	---	---	---		
	21	---	---	---	---	---	---		
240	06	418	556	623	1291	14	1.5	STRW 020 240 06 XXX	
	11	---	---	---	---	---	---		
	16	---	---	---	---	---	---		
	21	---	---	---	---	---	---		
260	06	453	603	675	1399		1.7	STRW 020 260 06 XXX	
	11	---	---	---	---	---	---		
	16	---	---	---	---	---	---		
	21	---	---	---	---	---	---		
280	06	488	649	727	1506	16	1.8	STRW 020 280 06 XXX	
	11	---	---	---	---	---	---		
	16	---	---	---	---	---	---		
	21	---	---	---	---	---	---		

Výkony měřeny podle EN442 při 20°C

vyplňte kód barvy

STRADA

VÝŠKA 035 (STANDARDNÍ)

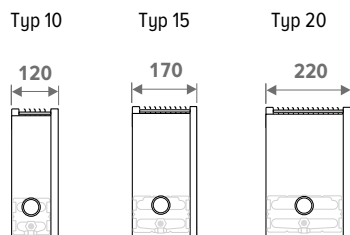

VÝŠKA H cm	DĚLKA L cm	TYP T	TOPENÍ Pokojová teplota 20°C				HMOTNOST kg	OBSAH VODY L	OBJEDNACÍ KÓD
			45/40 Watty	50/45 Watty	55/45 Watty	75/65 Watty			
STRW 035 050	---	---	---	---	---	---	---	---	
10	---	---	---	---	---	---	---	---	
15	---	---	147	195	218	449	5	0.3	STRW 035 050 10 XXX
20	---	---	242	320	358	735	7	0.5	STRW 035 050 15 XXX
			339	449	502	1030	8	0.7	STRW 035 050 20 XXX
060	---	---	---	---	---	---	---	---	
10	---	---	---	---	---	---	---	---	
15	---	---	176	234	262	539	6	0.4	STRW 035 060 10 XXX
20	---	---	290	385	430	882	8	0.6	STRW 035 060 15 XXX
			407	539	603	1236	9	0.8	STRW 035 060 20 XXX
070	---	---	---	---	---	---	---	---	
10	---	---	---	---	---	---	---	---	
15	---	---	206	273	305	629	7	0.5	STRW 035 070 10 XXX
20	---	---	339	449	502	1029	9	0.7	STRW 035 070 15 XXX
			475	629	703	1442	10	0.9	STRW 035 070 20 XXX
080	---	---	---	---	---	---	---	---	
10	---	---	---	---	---	---	---	---	
15	---	---	235	311	348	718	8	0.5	STRW 035 080 10 XXX
20	---	---	387	513	573	1176	10	0.8	STRW 035 080 15 XXX
			543	718	803	1648	11	1.1	STRW 035 080 20 XXX
090	---	---	---	---	---	---	---	---	
10	---	---	---	---	---	---	---	---	
15	---	---	264	350	392	808	9	0.6	STRW 035 090 10 XXX
20	---	---	436	577	645	1323	10	0.9	STRW 035 090 15 XXX
			610	808	904	1854	13	1.2	STRW 035 090 20 XXX
100	---	---	---	---	---	---	---	---	
10	---	---	---	---	---	---	---	---	
15	---	---	294	389	436	898	9	0.7	STRW 035 100 10 XXX
20	---	---	484	641	717	1470	11	1.0	STRW 035 100 15 XXX
			678	898	1004	2060	14	1.3	STRW 035 100 20 XXX
110	---	---	---	---	---	---	---	---	
10	---	---	---	---	---	---	---	---	
15	---	---	323	428	479	988	10	0.7	STRW 035 110 10 XXX
20	---	---	532	705	788	1617	12	1.1	STRW 035 110 15 XXX
			746	988	1105	2266	15	1.5	STRW 035 110 20 XXX
120	---	---	---	---	---	---	---	---	
10	---	---	---	---	---	---	---	---	
15	---	---	352	467	523	1078	11	0.8	STRW 035 120 10 XXX
20	---	---	581	769	860	1764	13	1.2	STRW 035 120 15 XXX
			814	1078	1205	2472	16	1.6	STRW 035 120 20 XXX
140	---	---	---	---	---	---	---	---	
10	---	---	---	---	---	---	---	---	
15	---	---	411	545	610	1257	13	0.8	STRW 035 140 10 XXX
20	---	---	678	897	1003	2058	16	1.2	STRW 035 140 15 XXX
			949	1257	1406	2884	19	1.6	STRW 035 140 20 XXX
160	---	---	---	---	---	---	---	---	
10	---	---	---	---	---	---	---	---	
15	---	---	470	623	697	1437	14	1.0	STRW 035 160 10 XXX
20	---	---	774	1025	1147	2352	18	1.6	STRW 035 160 15 XXX
			1085	1437	1607	3296	21	2.1	STRW 035 160 20 XXX
180	---	---	---	---	---	---	---	---	
10	---	---	---	---	---	---	---	---	
15	---	---	528	701	784	1616	16	1.2	STRW 035 180 10 XXX
20	---	---	871	1154	1290	2646	20	1.8	STRW 035 180 15 XXX
			1221	1617	1808	3708	23	2.4	STRW 035 180 20 XXX
200	---	---	---	---	---	---	---	---	
10	---	---	---	---	---	---	---	---	
15	---	---	587	779	872	1796	17	1.3	STRW 035 200 10 XXX
20	---	---	968	1282	1433	2940	21	2.0	STRW 035 200 15 XXX
			1356	1796	2009	4120	25	2.6	STRW 035 200 20 XXX
220	---	---	---	---	---	---	---	---	
10	---	---	---	---	---	---	---	---	
15	---	---	695	922	1031	2119	1.4	---	STRW 035 220 10 XXX
20	---	---	1140	1509	1686	3450	2.2	---	STRW 035 220 15 XXX
			1598	2114	2363	4831	2.9	---	STRW 035 220 20 XXX
240	---	---	---	---	---	---	---	---	
10	---	---	---	---	---	---	---	---	
15	---	---	704	934	1046	2155	21	1.6	STRW 035 240 10 XXX
20	---	---	1161	1538	1720	3528	26	2.4	STRW 035 240 15 XXX
			1628	2155	2410	4944	30	3.2	STRW 035 240 20 XXX
260	---	---	---	---	---	---	---	---	
10	---	---	---	---	---	---	---	---	
15	---	---	822	1089	1218	2504	1.7	---	STRW 035 260 10 XXX
20	---	---	1348	1783	1993	4077	2.5	---	STRW 035 260 15 XXX
			1889	2498	2792	5710	3.4	---	STRW 035 260 20 XXX
280	---	---	---	---	---	---	---	---	
10	---	---	---	---	---	---	---	---	
15	---	---	822	1090	1220	2514	24	1.8	STRW 035 280 10 XXX
20	---	---	1355	1794	2007	4116	29	2.7	STRW 035 280 15 XXX
			1899	2515	2812	5768	35	3.7	STRW 035 280 20 XXX

Výkony měřeny podle EN442 při 20°C

vyplňte kód barvy

Typ 06



Typ 11

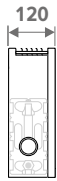

Typ 16

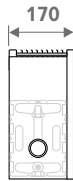

Typ 21

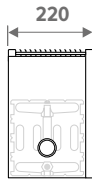

VÝŠKA H cm	DĚLKA L cm	TYP T	TOPENÍ Pokojová teplota 20°C				HMOTNOST OBSAH VODY		OBJEDNACÍ KÓD
			45/40 Watty	50/45 Watty	55/45 Watty	75/65 Watty	kg	L	
STRW 035 050	06	06	130	172	192	395	5	0.3	STRW 035 050 06 XXX
		11	189	253	284	598	6	0.7	STRW 035 050 11 XXX
		16	249	334	375	797	8	1.0	STRW 035 050 16 XXX
		21	326	439	494	1057	9	1.3	STRW 035 050 21 XXX
060	06	06	156	206	231	474	6	0.4	STRW 035 060 06 XXX
		11	227	304	341	718	7	0.8	STRW 035 060 11 XXX
		16	298	400	450	956	9	1.2	STRW 035 060 16 XXX
		21	391	526	593	1268	11	1.6	STRW 035 060 21 XXX
070	06	06	182	241	269	553	6	0.4	STRW 035 070 06 XXX
		11	265	354	398	837	8	0.9	STRW 035 070 11 XXX
		16	348	467	525	1115	10	1.4	STRW 035 070 16 XXX
		21	456	614	692	1480	12	1.9	STRW 035 070 21 XXX
080	06	06	208	275	308	632	7	0.5	STRW 035 080 06 XXX
		11	303	405	455	957	9	1.1	STRW 035 080 11 XXX
		16	397	533	600	1274	11	1.6	STRW 035 080 16 XXX
		21	521	702	790	1691	13	2.1	STRW 035 080 21 XXX
090	06	06	234	309	346	711	8	0.6	STRW 035 090 06 XXX
		11	340	455	511	1076	10	1.2	STRW 035 090 11 XXX
		16	447	600	675	1434	13	1.8	STRW 035 090 16 XXX
		21	587	790	889	1903	15	2.4	STRW 035 090 21 XXX
100	06	06	259	344	385	790	9	0.6	STRW 035 100 06 XXX
		11	378	506	568	1196	11	1.3	STRW 035 100 11 XXX
		16	497	667	750	1593	14	2.0	STRW 035 100 16 XXX
		21	652	878	988	2114	16	2.7	STRW 035 100 21 XXX
110	06	06	285	378	423	869	9	0.7	STRW 035 110 06 XXX
		11	416	557	625	1316	12	1.5	STRW 035 110 11 XXX
		16	546	733	825	1752	15	2.2	STRW 035 110 16 XXX
		21	717	965	1086	2325	18	2.9	STRW 035 110 21 XXX
120	06	06	311	413	461	948	10	0.8	STRW 035 120 06 XXX
		11	454	607	682	1435	13	1.6	STRW 035 120 11 XXX
		16	596	800	900	1912	16	2.4	STRW 035 120 16 XXX
		21	782	1053	1186	2537	19	3.2	STRW 035 120 21 XXX
140	06	06	363	481	538	1106	12	0.8	STRW 035 140 06 XXX
		11	530	708	795	1674	15	1.6	STRW 035 140 11 XXX
		16	695	934	1050	2230	19	2.4	STRW 035 140 16 XXX
		21	913	1229	1383	2960	23	3.2	STRW 035 140 21 XXX
160	06	06	415	550	615	1264	13	1.0	STRW 035 160 06 XXX
		11	605	810	909	1914	17	2.1	STRW 035 160 11 XXX
		16	795	1067	1200	2549	21	3.2	STRW 035 160 16 XXX
		21	1043	1404	1580	3382	25	4.3	STRW 035 160 21 XXX
180	06	06	467	619	692	1422	15	1.2	STRW 035 180 06 XXX
		11	681	911	1023	2153	19	2.4	STRW 035 180 11 XXX
		16	894	1200	1349	2867	23	3.6	STRW 035 180 16 XXX
		21	1173	1580	1778	3805	28	4.8	STRW 035 180 21 XXX
200	06	06	519	688	769	1580	16	1.3	STRW 035 200 06 XXX
		11	757	1012	1136	2392	20	2.7	STRW 035 200 11 XXX
		16	993	1334	1500	3186	25	4.0	STRW 035 200 16 XXX
		21	1304	1755	1976	4228	31	5.3	STRW 035 200 21 XXX
220	06	06	586	771	861	1738	1.4		STRW 035 220 06 XXX
		11	880	1177	1322	2781	2.9		STRW 035 220 11 XXX
		16	1164	1564	1759	3740	4.4		STRW 035 220 16 XXX
		21	1536	2071	2332	5003	5.9		STRW 035 220 21 XXX
240	06	06	623	825	923	1896	20	1.5	STRW 035 240 06 XXX
		11	908	1214	1363	2870	24	3.2	STRW 035 240 11 XXX
		16	1192	1600	1799	3823	30	4.8	STRW 035 240 16 XXX
		21	1564	2106	2371	5074	37	6.4	STRW 035 240 21 XXX
260	06	06	693	912	1017	2054	1.7		STRW 035 260 06 XXX
		11	1040	1391	1562	3286	3.5		STRW 035 260 11 XXX
		16	1376	1848	2078	4420	5.1		STRW 035 260 16 XXX
		21	1816	2447	2755	5912	6.9		STRW 035 260 21 XXX
280	06	06	726	963	1077	2212	22	1.8	STRW 035 280 06 XXX
		11	1059	1417	1591	3349	28	3.7	STRW 035 280 11 XXX
		16	1391	1867	2099	4460	34	5.5	STRW 035 280 16 XXX
		21	1825	2457	2766	5919	43	7.4	STRW 035 280 21 XXX

Výkony měřeny podle EN442 při 20°C

vyplňte kód barvy

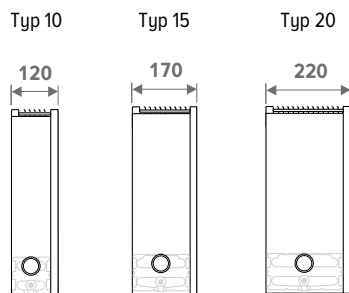

VÝŠKA H cm	DĚLKA L cm	TYP T	TOPENÍ Pokojová teplota 20°C				HMOTNOST kg	OBSAH VODY L	OBJEDNACÍ KÓD
			45/40 Watty	50/45 Watty	55/45 Watty	75/65 Watty			
STRW 050	050	---	---	---	---	---	---	---	
10	---	---	178	235	263	538	7	0.3	STRW 050 050 10 XXX
15	---	---	289	382	426	867	8	0.5	STRW 050 050 15 XXX
20	---	---	405	534	597	1213	10	0.7	STRW 050 050 20 XXX
060	---	---	---	---	---	---	---	---	
10	---	---	214	282	316	646	8	0.4	STRW 050 060 10 XXX
15	---	---	347	458	511	1040	9	0.6	STRW 050 060 15 XXX
20	---	---	486	641	716	1455	11	0.8	STRW 050 060 20 XXX
070	---	---	---	---	---	---	---	---	
10	---	---	249	329	368	753	9	0.5	STRW 050 070 10 XXX
15	---	---	405	535	597	1214	11	0.7	STRW 050 070 15 XXX
20	---	---	567	748	835	1698	12	0.9	STRW 050 070 20 XXX
080	---	---	---	---	---	---	---	---	
10	---	---	285	376	421	861	10	0.5	STRW 050 080 10 XXX
15	---	---	463	611	682	1387	12	0.8	STRW 050 080 15 XXX
20	---	---	647	854	954	1940	14	1.1	STRW 050 080 20 XXX
090	---	---	---	---	---	---	---	---	
10	---	---	320	423	473	968	11	0.6	STRW 050 090 10 XXX
15	---	---	521	687	768	1561	13	0.9	STRW 050 090 15 XXX
20	---	---	729	961	1074	2183	15	1.2	STRW 050 090 20 XXX
100	---	---	---	---	---	---	---	---	
10	---	---	356	471	526	1076	12	0.7	STRW 050 100 10 XXX
15	---	---	579	764	853	1734	14	1.0	STRW 050 100 15 XXX
20	---	---	809	1068	1193	2425	16	1.3	STRW 050 100 20 XXX
110	---	---	---	---	---	---	---	---	
10	---	---	391	518	579	1184	12	0.7	STRW 050 110 10 XXX
15	---	---	636	840	938	1907	15	1.1	STRW 050 110 15 XXX
20	---	---	890	1175	1312	2668	18	1.5	STRW 050 110 20 XXX
120	---	---	---	---	---	---	---	---	
10	---	---	427	565	631	1291	13	0.8	STRW 050 120 10 XXX
15	---	---	694	917	1023	2081	16	1.2	STRW 050 120 15 XXX
20	---	---	971	1282	1431	2910	19	1.6	STRW 050 120 20 XXX
140	---	---	---	---	---	---	---	---	
10	---	---	498	659	736	1506	16	0.8	STRW 050 140 10 XXX
15	---	---	810	1069	1194	2428	19	1.2	STRW 050 140 15 XXX
20	---	---	1133	1495	1670	3395	22	1.6	STRW 050 140 20 XXX
160	---	---	---	---	---	---	---	---	
10	---	---	569	753	842	1722	18	1.0	STRW 050 160 10 XXX
15	---	---	926	1222	1364	2774	21	1.6	STRW 050 160 15 XXX
20	---	---	1295	1709	1908	3880	25	2.1	STRW 050 160 20 XXX
180	---	---	---	---	---	---	---	---	
10	---	---	640	847	947	1937	20	1.2	STRW 050 180 10 XXX
15	---	---	1042	1375	1535	3121	23	1.8	STRW 050 180 15 XXX
20	---	---	1457	1922	2147	4365	27	2.4	STRW 050 180 20 XXX
200	---	---	---	---	---	---	---	---	
10	---	---	711	941	1052	2152	21	1.3	STRW 050 200 10 XXX
15	---	---	1157	1527	1706	3468	26	2.0	STRW 050 200 15 XXX
20	---	---	1619	2136	2385	4850	30	2.6	STRW 050 200 20 XXX
220	---	---	---	---	---	---	---	---	
10	---	---	782	1035	1157	2367	1.4	---	STRW 050 220 10 XXX
15	---	---	1273	1680	1876	3815	2.2	---	STRW 050 220 15 XXX
20	---	---	1780	2350	2624	5335	2.9	---	STRW 050 220 20 XXX
240	---	---	---	---	---	---	---	---	
10	---	---	853	1129	1262	2582	26	1.6	STRW 050 240 10 XXX
15	---	---	1389	1833	2047	4162	31	2.4	STRW 050 240 15 XXX
20	---	---	1942	2563	2862	5820	36	3.2	STRW 050 240 20 XXX
260	---	---	---	---	---	---	---	---	
10	---	---	925	1223	1368	2798	1.7	---	STRW 050 260 10 XXX
15	---	---	1504	1985	2217	4508	2.5	---	STRW 050 260 15 XXX
20	---	---	2104	2777	3101	6305	3.4	---	STRW 050 260 20 XXX
280	---	---	---	---	---	---	---	---	
10	---	---	996	1318	1473	3013	29	1.8	STRW 050 280 10 XXX
15	---	---	1620	2138	2388	4855	35	2.7	STRW 050 280 15 XXX
20	---	---	2266	2990	3339	6790	41	3.7	STRW 050 280 20 XXX

Výkony měřeny podle EN442 při 20°C

vyplňte kód barvy

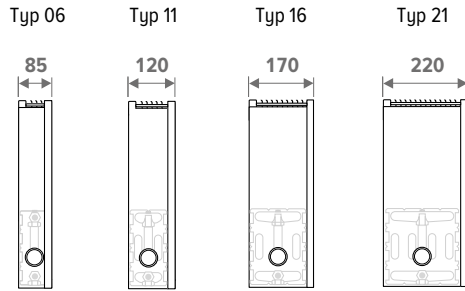

VÝŠKA H cm	DĚLKA L cm	TYP T	TOPENÍ Pokojová teplota 20°C				HMOTNOST OBSAH VODY		OBJEDNACÍ KÓD
			45/40 Watty	50/45 Watty	55/45 Watty	75/65 Watty	kg	L	
STRW 050	050	06	158	209	233	474	6	0.3	STRW 050 050 06 XXX
		11	220	294	330	693	8	0.7	STRW 050 050 11 XXX
		16	294	396	445	949	10	1.0	STRW 050 050 16 XXX
		21	394	532	599	1291	11	1.3	STRW 050 050 21 XXX
060	060	06	190	250	279	568	7	0.4	STRW 050 060 06 XXX
		11	264	352	396	832	9	0.8	STRW 050 060 11 XXX
		16	353	475	534	1139	11	1.2	STRW 050 060 16 XXX
		21	473	638	719	1549	13	1.6	STRW 050 060 21 XXX
070	070	06	221	292	326	663	8	0.4	STRW 050 070 06 XXX
		11	307	411	461	970	10	0.9	STRW 050 070 11 XXX
		16	412	554	624	1329	12	1.4	STRW 050 070 16 XXX
		21	551	744	839	1807	14	1.9	STRW 050 070 21 XXX
080	080	06	253	334	373	758	9	0.5	STRW 050 080 06 XXX
		11	351	470	527	1109	11	1.1	STRW 050 080 11 XXX
		16	471	633	712	1518	13	1.6	STRW 050 080 16 XXX
		21	630	851	959	2066	16	2.1	STRW 050 080 21 XXX
090	090	06	285	375	419	852	10	0.6	STRW 050 090 06 XXX
		11	395	528	593	1247	12	1.2	STRW 050 090 11 XXX
		16	530	712	801	1708	15	1.8	STRW 050 090 16 XXX
		21	709	957	1079	2324	18	2.4	STRW 050 090 21 XXX
100	100	06	316	417	466	947	11	0.6	STRW 050 100 06 XXX
		11	439	587	659	1386	13	1.3	STRW 050 100 11 XXX
		16	589	792	891	1898	16	2.0	STRW 050 100 16 XXX
		21	788	1064	1198	2582	19	2.7	STRW 050 100 21 XXX
110	110	06	348	459	513	1042	12	0.7	STRW 050 110 06 XXX
		11	483	646	725	1525	14	1.5	STRW 050 110 11 XXX
		16	648	871	980	2088	17	2.2	STRW 050 110 16 XXX
		21	867	1170	1318	2840	21	2.9	STRW 050 110 21 XXX
120	120	06	379	501	559	1136	13	0.8	STRW 050 120 06 XXX
		11	527	705	791	1663	15	1.6	STRW 050 120 11 XXX
		16	707	950	1069	2278	19	2.4	STRW 050 120 16 XXX
		21	945	1276	1438	3098	22	3.2	STRW 050 120 21 XXX
140	140	06	443	584	652	1326	15	0.8	STRW 050 140 06 XXX
		11	615	822	923	1940	18	1.6	STRW 050 140 11 XXX
		16	825	1108	1247	2657	23	2.4	STRW 050 140 16 XXX
		21	1103	1489	1678	3615	27	3.2	STRW 050 140 21 XXX
160	160	06	506	668	745	1515	16	1.0	STRW 050 160 06 XXX
		11	703	940	1055	2218	20	2.1	STRW 050 160 11 XXX
		16	942	1267	1425	3037	25	3.2	STRW 050 160 16 XXX
		21	1261	1702	1917	4131	29	4.3	STRW 050 160 21 XXX
180	180	06	569	751	839	1705	18	1.2	STRW 050 180 06 XXX
		11	790	1057	1187	2495	22	2.4	STRW 050 180 11 XXX
		16	1060	1425	1603	3416	27	3.6	STRW 050 180 16 XXX
		21	1418	1915	2157	4648	32	4.8	STRW 050 180 21 XXX
200	200	06	633	835	932	1894	20	1.3	STRW 050 200 06 XXX
		11	878	1174	1318	2772	24	2.7	STRW 050 200 11 XXX
		16	1178	1583	1781	3796	29	4.0	STRW 050 200 16 XXX
		21	1576	2127	2397	5164	36	5.3	STRW 050 200 21 XXX
220	220	06	691	914	1021	2083	1.4	STRW 050 220 06 XXX	
		11	966	1292	1450	3049	2.9	STRW 050 220 11 XXX	
		16	1296	1742	1959	4176	4.4	STRW 050 220 16 XXX	
		21	1733	2340	2636	5680	5.9	STRW 050 220 21 XXX	
240	240	06	759	1002	1118	2273	24	1.5	STRW 050 240 06 XXX
		11	1054	1409	1582	3326	29	3.2	STRW 050 240 11 XXX
		16	1413	1900	2137	4555	35	4.8	STRW 050 240 16 XXX
		21	1891	2553	2876	6197	42	6.4	STRW 050 240 21 XXX
260	260	06	817	1080	1206	2462	1.7	STRW 050 260 06 XXX	
		11	1142	1527	1714	3604	3.5	STRW 050 260 11 XXX	
		16	1531	2058	2316	4935	5.1	STRW 050 260 16 XXX	
		21	2048	2765	3116	6713	6.9	STRW 050 260 21 XXX	
280	280	06	886	1169	1305	2652	28	1.8	STRW 050 280 06 XXX
		11	1230	1644	1846	3881	34	3.7	STRW 050 280 11 XXX
		16	1649	2217	2493	5314	40	5.5	STRW 050 280 16 XXX
		21	2206	2978	3356	7230	49	7.4	STRW 050 280 21 XXX

Výkony měřeny podle EN442 při 20°C

vyplňte kód barvy

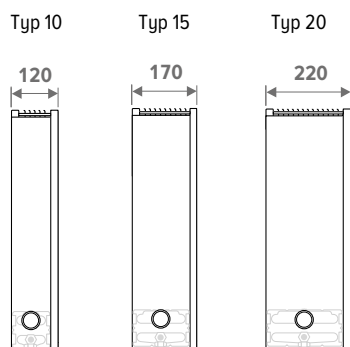

VÝŠKA H cm	DĚLKA L cm	TYP T	TOPENÍ Pokojová teplota 20°C				HMOTNOST kg	OBSAH VODY L	OBJEDNACÍ KÓD
			45/40 Watty	50/45 Watty	55/45 Watty	75/65 Watty			
STRW 065	050	---	---	---	---	---	---	---	
10			203	267	298	606	8	0.3	STRW 065 050 10 XXX
15			325	428	477	961	10	0.5	STRW 065 050 15 XXX
20			455	598	667	1343	12	0.7	STRW 065 050 20 XXX
060			---	---	---	---	---	---	
10			243	321	358	727	10	0.4	STRW 065 060 10 XXX
15			390	513	572	1153	11	0.6	STRW 065 060 15 XXX
20			545	717	800	1611	13	0.8	STRW 065 060 20 XXX
070			---	---	---	---	---	---	
10			283	374	417	848	11	0.5	STRW 065 070 10 XXX
15			455	599	668	1345	13	0.7	STRW 065 070 15 XXX
20			636	837	933	1880	15	0.9	STRW 065 070 20 XXX
080			---	---	---	---	---	---	
10			324	427	477	969	12	0.5	STRW 065 080 10 XXX
15			521	685	763	1538	14	0.8	STRW 065 080 15 XXX
20			727	956	1066	2148	16	1.1	STRW 065 080 20 XXX
090			---	---	---	---	---	---	
10			364	481	537	1090	13	0.6	STRW 065 090 10 XXX
15			586	770	859	1730	15	0.9	STRW 065 090 15 XXX
20			818	1076	1200	2417	18	1.2	STRW 065 090 20 XXX
100			---	---	---	---	---	---	
10			405	534	596	1211	14	0.7	STRW 065 100 10 XXX
15			651	856	954	1922	16	1.0	STRW 065 100 15 XXX
20			909	1195	1333	2685	19	1.3	STRW 065 100 20 XXX
110			---	---	---	---	---	---	
10			445	587	656	1332	15	0.7	STRW 065 110 10 XXX
15			716	941	1049	2114	18	1.1	STRW 065 110 15 XXX
20			1000	1315	1466	2954	20	1.5	STRW 065 110 20 XXX
120			---	---	---	---	---	---	
10			486	641	715	1453	16	0.8	STRW 065 120 10 XXX
15			781	1027	1145	2306	19	1.2	STRW 065 120 15 XXX
20			1091	1434	1599	3222	22	1.6	STRW 065 120 20 XXX
140			---	---	---	---	---	---	
10			567	747	835	1695	19	0.8	STRW 065 140 10 XXX
15			911	1198	1336	2691	22	1.2	STRW 065 140 15 XXX
20			1273	1673	1866	3759	26	1.6	STRW 065 140 20 XXX
160			---	---	---	---	---	---	
10			648	855	954	1938	21	1.0	STRW 065 160 10 XXX
15			1041	1369	1526	3075	25	1.6	STRW 065 160 15 XXX
20			1454	1912	2133	4296	29	2.1	STRW 065 160 20 XXX
180			---	---	---	---	---	---	
10			729	961	1073	2180	23	1.2	STRW 065 180 10 XXX
15			1171	1540	1718	3460	27	1.8	STRW 065 180 15 XXX
20			1636	2152	2399	4833	32	2.4	STRW 065 180 20 XXX
200			---	---	---	---	---	---	
10			810	1068	1192	2422	25	1.3	STRW 065 200 10 XXX
15			1301	1711	1908	3844	30	2.0	STRW 065 200 15 XXX
20			1818	2391	2666	5370	34	2.6	STRW 065 200 20 XXX
220			---	---	---	---	---	---	
10			922	1214	1355	2746	1.4	---	STRW 065 220 10 XXX
15			1475	1937	2159	4338	2.2	---	STRW 065 220 15 XXX
20			2061	2706	3016	6057	2.9	---	STRW 065 220 20 XXX
240			---	---	---	---	---	---	
10			971	1281	1431	2906	31	1.6	STRW 065 240 10 XXX
15			1562	2054	2290	4613	36	2.4	STRW 065 240 15 XXX
20			2182	2869	3199	6444	41	3.2	STRW 065 240 20 XXX
260			---	---	---	---	---	---	
10			1089	1435	1602	3245	1.7	---	STRW 065 260 10 XXX
15			1743	2289	2552	5127	2.5	---	STRW 065 260 15 XXX
20			2435	3198	3564	7158	3.4	---	STRW 065 260 20 XXX
280			---	---	---	---	---	---	
10			1133	1495	1669	3391	35	1.8	STRW 065 280 10 XXX
15			1822	2396	2672	5382	41	2.7	STRW 065 280 15 XXX
20			2545	3347	3732	7518	47	3.7	STRW 065 280 20 XXX

Výkony měřeny podle EN442 při 20°C

vyplňte kód barvy

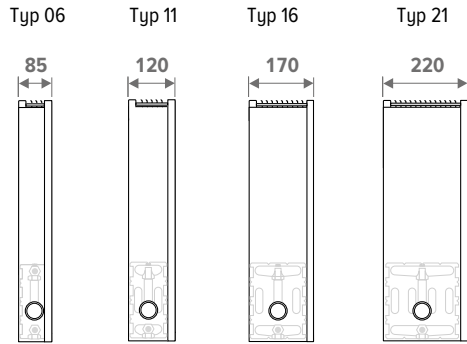

VÝŠKA H cm	DĚLKA L cm	TYP T	TOPENÍ Pokojová teplota 20°C				HMOTNOST OBSAH VODY		OBJEDNACÍ KÓD
			45/40 Watty	50/45 Watty	55/45 Watty	75/65 Watty	kg	L	
STRW 065	050	06	181	238	265	533	8	0.3	STRW 065 050 06 XXX
		11	245	327	367	772	9	0.7	STRW 065 050 11 XXX
		16	336	452	508	1087	11	1.0	STRW 065 050 16 XXX
		21	458	620	699	1515	13	1.3	STRW 065 050 21 XXX
060	06	06	218	286	319	640	9	0.4	STRW 065 060 06 XXX
		11	294	393	441	926	10	0.8	STRW 065 060 11 XXX
		16	403	542	610	1304	13	1.2	STRW 065 060 16 XXX
		21	549	744	839	1818	15	1.6	STRW 065 060 21 XXX
070	06	06	254	333	371	746	10	0.4	STRW 065 070 06 XXX
		11	342	458	514	1080	12	0.9	STRW 065 070 11 XXX
		16	470	632	711	1521	14	1.4	STRW 065 070 16 XXX
		21	641	867	978	2121	16	1.9	STRW 065 070 21 XXX
080	06	06	290	381	425	853	11	0.5	STRW 065 080 06 XXX
		11	391	523	587	1234	13	1.1	STRW 065 080 11 XXX
		16	537	722	813	1738	16	1.6	STRW 065 080 16 XXX
		21	733	991	1118	2424	18	2.1	STRW 065 080 21 XXX
090	06	06	326	428	477	959	12	0.6	STRW 065 090 06 XXX
		11	440	589	661	1389	14	1.2	STRW 065 090 11 XXX
		16	604	813	915	1956	17	1.8	STRW 065 090 16 XXX
		21	824	1115	1258	2727	20	2.4	STRW 065 090 21 XXX
100	06	06	362	476	531	1066	13	0.6	STRW 065 100 06 XXX
		11	489	654	734	1543	15	1.3	STRW 065 100 11 XXX
		16	671	903	1016	2173	19	2.0	STRW 065 100 16 XXX
		21	916	1239	1398	3030	22	2.7	STRW 065 100 21 XXX
110	06	06	399	524	584	1173	14	0.7	STRW 065 110 06 XXX
		11	538	719	807	1697	17	1.5	STRW 065 110 11 XXX
		16	738	993	1118	2390	20	2.2	STRW 065 110 16 XXX
		21	1007	1363	1537	3333	23	2.9	STRW 065 110 21 XXX
120	06	06	435	571	637	1279	15	0.8	STRW 065 120 06 XXX
		11	587	785	881	1852	18	1.6	STRW 065 120 11 XXX
		16	805	1084	1220	2608	22	2.4	STRW 065 120 16 XXX
		21	1099	1487	1677	3636	25	3.2	STRW 065 120 21 XXX
140	06	06	507	666	743	1492	18	0.8	STRW 065 140 06 XXX
		11	685	916	1028	2160	21	1.6	STRW 065 140 11 XXX
		16	939	1264	1423	3042	26	2.4	STRW 065 140 16 XXX
		21	1282	1735	1957	4242	31	3.2	STRW 065 140 21 XXX
160	06	06	580	762	849	1706	20	1.0	STRW 065 160 06 XXX
		11	783	1047	1175	2469	24	2.1	STRW 065 160 11 XXX
		16	1074	1445	1626	3477	28	3.2	STRW 065 160 16 XXX
		21	1465	1983	2236	4848	33	4.3	STRW 065 160 21 XXX
180	06	06	652	857	955	1919	22	1.2	STRW 065 180 06 XXX
		11	881	1177	1321	2777	26	2.4	STRW 065 180 11 XXX
		16	1208	1626	1829	3911	31	3.6	STRW 065 180 16 XXX
		21	1648	2231	2516	5454	37	4.8	STRW 065 180 21 XXX
200	06	06	725	952	1061	2132	24	1.3	STRW 065 200 06 XXX
		11	979	1308	1468	3086	29	2.7	STRW 065 200 11 XXX
		16	1342	1806	2033	4346	34	4.0	STRW 065 200 16 XXX
		21	1832	2478	2795	6060	40	5.3	STRW 065 200 21 XXX
220	06	06	766	1016	1137	2345	1.4		STRW 065 220 06 XXX
		11	1110	1484	1665	3498	2.9		STRW 065 220 11 XXX
		16	1533	2064	2323	4972	4.4		STRW 065 220 16 XXX
		21	2106	2852	3217	6989	5.9		STRW 065 220 21 XXX
240	06	06	870	1142	1273	2558	29	1.5	STRW 065 240 06 XXX
		11	1174	1570	1762	3703	34	3.2	STRW 065 240 11 XXX
		16	1611	2168	2439	5215	40	4.8	STRW 065 240 16 XXX
		21	2198	2974	3355	7272	48	6.4	STRW 065 240 21 XXX
260	06	06	905	1201	1344	2772	1.7		STRW 065 260 06 XXX
		11	1312	1753	1968	4134	3.5		STRW 065 260 11 XXX
		16	1812	2439	2746	5876	5.1		STRW 065 260 16 XXX
		21	2488	3370	3802	8260	6.9		STRW 065 260 21 XXX
280	06	06	1015	1333	1486	2985	33	1.8	STRW 065 280 06 XXX
		11	1370	1831	2056	4320	39	3.7	STRW 065 280 11 XXX
		16	1879	2529	2846	6084	46	5.5	STRW 065 280 16 XXX
		21	2564	3470	3914	8484	55	7.4	STRW 065 280 21 XXX

Výkony měřeny podle EN442 při 20°C

vyplňte kód barvy

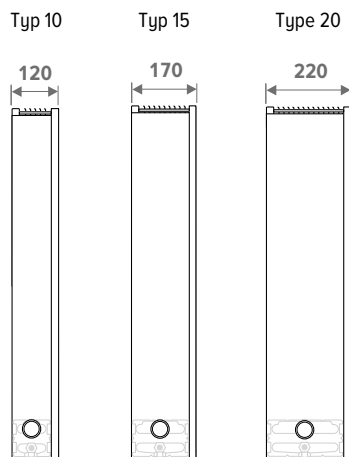

VÝŠKA H cm	DĚLKA L cm	TYP T	TOPENÍ Pokojová teplota 20°C				HMOTNOST kg	OBSAH VODY L	OBJEDNACÍ KÓD
			45/40 Watty	50/45 Watty	55/45 Watty	75/65 Watty			
STRW 095	050	---	---	---	---	---	---	---	
	10	---	---	---	---	---	---	---	
	15	---	---	---	---	---	---	---	
	20	---	---	---	---	---	---	---	
	060	---	---	---	---	---	---	---	
	10	286	375	418	836	14	0.4	STRW 095 060 10 XXX	
	15	448	586	651	1288	17	0.6	STRW 095 060 15 XXX	
	20	625	816	907	1795	19	0.8	STRW 095 060 20 XXX	
	070	---	---	---	---	---	---	---	
	10	333	437	487	975	16	0.5	STRW 095 070 10 XXX	
	15	523	683	759	1502	18	0.7	STRW 095 070 15 XXX	
	20	729	952	1058	2094	21	0.9	STRW 095 070 20 XXX	
	080	---	---	---	---	---	---	---	
	10	381	499	556	1114	17	0.5	STRW 095 080 10 XXX	
	15	598	781	868	1717	20	0.8	STRW 095 080 15 XXX	
	20	834	1088	1210	2394	23	1.1	STRW 095 080 20 XXX	
	090	---	---	---	---	---	---	---	
	10	429	562	626	1254	18	0.6	STRW 095 090 10 XXX	
	15	672	878	976	1931	21	0.9	STRW 095 090 15 XXX	
	20	938	1224	1361	2693	24	1.2	STRW 095 090 20 XXX	
	100	---	---	---	---	---	---	---	
	10	476	625	696	1393	20	0.7	STRW 095 100 10 XXX	
	15	747	976	1085	2146	23	1.0	STRW 095 100 15 XXX	
	20	1042	1360	1512	2992	26	1.3	STRW 095 100 20 XXX	
	110	---	---	---	---	---	---	---	
	10	524	687	765	1532	21	0.7	STRW 095 110 10 XXX	
	15	822	1073	1193	2361	25	1.1	STRW 095 110 15 XXX	
	20	1146	1496	1664	3291	28	1.5	STRW 095 110 20 XXX	
	120	---	---	---	---	---	---	---	
	10	572	750	835	1672	25	0.8	STRW 095 120 10 XXX	
	15	897	1171	1302	2575	29	1.2	STRW 095 120 15 XXX	
	20	1250	1632	1815	3590	33	1.6	STRW 095 120 20 XXX	
	140	---	---	---	---	---	---	---	
	10	667	874	974	1950	25	0.8	STRW 095 140 10 XXX	
	15	1046	1366	1518	3004	29	1.2	STRW 095 140 15 XXX	
	20	1458	1904	2117	4189	33	1.6	STRW 095 140 20 XXX	

Výkony měřeny podle EN442 při 20°C

vyplňte kód barvy

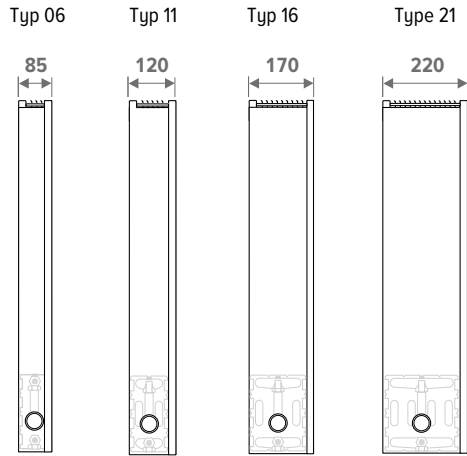

VÝŠKA H cm	DÉLKA L cm	TYP T	TOPENÍ Pokojová teplota 20°C				HMOTNOST kg	OBSAH VODY L	OBJEDNACÍ KÓD
			45/40 Watty	50/45 Watty	55/45 Watty	75/65 Watty			
STRW 095	050	06	---	---	---	---	---	---	---
		11	---	---	---	---	---	---	---
		16	---	---	---	---	---	---	---
		21	---	---	---	---	---	---	---
060	06	06	259	337	375	736	12	0.4	STRW 095 060 06 XXX
		11	343	458	514	1078	14	0.8	STRW 095 060 11 XXX
		16	491	663	747	1606	16	1.2	STRW 095 060 16 XXX
		21	697	948	1071	2352	19	1.6	STRW 095 060 21 XXX
070	06	06	302	393	437	858	13	0.4	STRW 095 070 06 XXX
		11	400	534	599	1257	15	0.9	STRW 095 070 11 XXX
		16	573	773	871	1874	18	1.4	STRW 095 070 16 XXX
		21	813	1106	1250	2744	21	1.9	STRW 095 070 21 XXX
080	06	06	345	449	499	981	14	0.5	STRW 095 080 06 XXX
		11	457	610	685	1437	17	1.1	STRW 095 080 11 XXX
		16	655	884	996	2142	20	1.6	STRW 095 080 16 XXX
		21	929	1264	1428	3136	23	2.1	STRW 095 080 21 XXX
090	06	06	388	505	561	1103	16	0.6	STRW 095 090 06 XXX
		11	514	686	770	1616	18	1.2	STRW 095 090 11 XXX
		16	737	994	1120	2409	22	1.8	STRW 095 090 16 XXX
		21	1045	1421	1607	3528	25	2.4	STRW 095 090 21 XXX
100	06	06	431	562	624	1226	17	0.6	STRW 095 100 06 XXX
		11	571	763	856	1796	20	1.3	STRW 095 100 11 XXX
		16	819	1105	1244	2677	24	2.0	STRW 095 100 16 XXX
		21	1161	1579	1785	3920	27	2.7	STRW 095 100 21 XXX
110	06	06	475	618	686	1349	18	0.7	STRW 095 110 06 XXX
		11	628	839	942	1976	22	1.5	STRW 095 110 11 XXX
		16	901	1215	1369	2945	25	2.2	STRW 095 110 16 XXX
		21	1277	1737	1964	4312	29	2.9	STRW 095 110 21 XXX
120	06	06	518	674	749	1471	20	0.8	STRW 095 120 06 XXX
		11	685	915	1027	2155	23	1.6	STRW 095 120 11 XXX
		16	982	1325	1493	3212	27	2.4	STRW 095 120 16 XXX
		21	1394	1895	2142	4704	31	3.2	STRW 095 120 21 XXX
140	06	06	604	786	873	1716	23	0.8	STRW 095 140 06 XXX
		11	799	1068	1198	2514	27	1.6	STRW 095 140 11 XXX
		16	1146	1547	1742	3748	33	2.4	STRW 095 140 16 XXX
		21	1626	2211	2499	5488	38	3.2	STRW 095 140 21 XXX

Výkony měřeny podle EN442 při 20°C

vyplňte kód barvy

STRADA

JEDNOTLIVÉ DÍLY

KRYT



STANDARDNÍ DODÁVKA:

- mřížkou
- čelní panel
- 2 bočnice
- zadní lišta
- krycí destičky
- barva 133, 001 nebo 145

OBJEDNACÍ KÓD

CSTW 020 050 06 XXX

Barva
Typ
Délka
Výška

TOPNÁ SADA



STANDARDNÍ DODÁVKA:

- Výměník tepla
- stěnové konzole
- rohový odvzdušňovací ventil 1/8" (VÝŠKA 020) nebo Prodloužený odvzdušňovací ventil 1/8"
- kotvící sada
- výpustná zátka 1/2"

OBJEDNACÍ KÓD

HSTW 020 050 06

Typ
Délka
Výška

MŘÍŽKOU

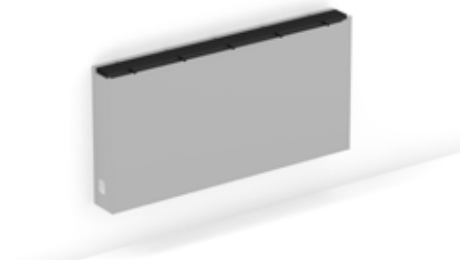

STANDARDNÍ DODÁVKA:

- barva 133, 001 nebo 145

OBJEDNACÍ KÓD

5621 000 050 06 XXX

Barva
Typ
Délka

ZADNÍ LIŠTA

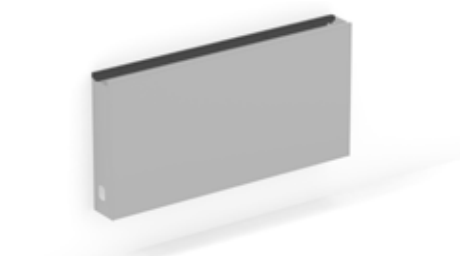

STANDARDNÍ DODÁVKA:

- barva 133, 001 nebo 145

OBJEDNACÍ KÓD

5521 000 050 00 XXX

Barva
Délka

ČELNÍ PANEL

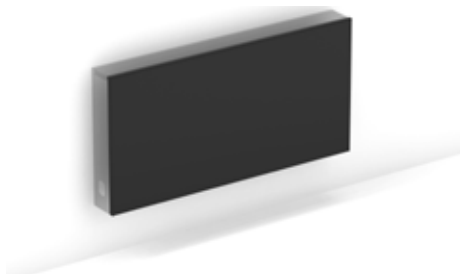

STANDARDNÍ DODÁVKA:

- barva 133, 001 nebo 145

OBJEDNACÍ KÓD

5503 020 050 00 XXX

Barva
Délka
Výška

BOČNICE (v páru)



STANDARDNÍ DODÁVKA:

- barva 133, 001 nebo 145

OBJEDNACÍ KÓD

5271 020 000 06 XXX

Barva
Typ
VÝŠKA

STRADA

JEDNOTLIVÉ DÍLY

KRYCÍ DESKA (stříbrná)



KRYCÍ DESKA (bílá)



UPEVŇOVACÍ SADA PRO ZADNÍ LIŠTU (v páru)



KONZOLE (na jednotku)



VÝMĚNÍK TEPLA



Počet konzol na výměník tepla

- od délky 050 do 110 cm: 2 kusy
- od délky 120 do 220 cm: 3 kusy
- od délky 240 do 280 cm: 4 kusy

STANDARDNÍ DODÁVKA:

- Výměník tepla
- vč. rohového dovzdušňovacího ventilu a výpustné zátky

OBJEDNACÍ KÓD

22165 000 400 11

OBJEDNACÍ KÓD

22165 000 400 12

OBJEDNACÍ KÓD

5521 011

OBJEDNACÍ KÓD

5121 020 000 06







Typ výměníku tepla
Výška

OBJEDNACÍ KÓD

5003 000 050 06

Typ výměníku tepla
Délka

Přehled typů výměníku tepla

	Strada Typ 06	Strada Typ 10	Strada Typ 11	Strada Typ 15	Strada Typ 16	Strada Typ 20	Strada Typ 21
Výška 020	 Typ 07	 Typ 10		 Typ 15		 Typ 20	
Výška 035 Výška 050 Výška 065 Výška 095	 Typ 08	 Typ 10	 Typ 11	 Typ 15	 Typ 16	 Typ 20	 Typ 21

PRODLOUŽENÝ ODVZDUŠŇOVACÍ VENTIL 1/8"



OBJEDNACÍ KÓD	H20				H35				H50				H65				H95								
	Typ 06	10	15	20	06	10	11	15	16	20	21	06	10	11	15	16	20	21	06	10	11	15	16	20	21
50900 114 078	-	✓	✓	✓	✓	-	✓	-	✓	-	✓	-	-	-	-	-	-	-	-	-	-	-	-	-	-
50900 114 178	-	-	-	-	-	✓	-	✓	-	✓	-	-	-	-	-	-	-	-	-	-	-	-	-	-	-
50900 114 278	-	-	-	-	-	-	-	-	-	-	-	✓	-	✓	-	✓	-	✓	-	✓	-	✓	-	✓	-
50900 114 378	-	-	-	-	-	-	-	-	-	-	-	✓	-	✓	-	✓	-	✓	-	✓	-	✓	-	✓	-
50900 114 528	-	-	-	-	-	-	-	-	-	-	-	-	✓	-	✓	-	✓	-	✓	-	✓	-	✓	-	✓
50900 114 728	-	-	-	-	-	-	-	-	-	-	-	-	-	-	-	-	-	-	-	✓	✓	✓	✓	✓	✓

Uváděný výkon s ΔT 50 a ΔT 42.5 je přesný výkon. Výkon ΔT 50 je měřen v souladu s EN442 a výkon ΔT 42.5 se počítá v souladu s EN442. Pro všechny ostatní výkony ΔT je průměrný korekční faktor uveden v této tabulce a vztahuje se na všechny rozměry

Na www.jaga.com/selection-tools/ si můžete stáhnout program, tabulky přepočtů s přesnými výkony pro jednotlivá tělesa. Informace v programech jsou aktualizovány podle nejnovějších dat. Drobné rozdíly mezi tištěnými tabulkami výkonů a různými online výpočtovými nástroji jsou proto zcela normální a spadají do tolerančních limitů stanovených normou.

PRŮMĚRNÉ KOREKČNÍ FAKTORY PRO STATICKÁ TĚLESA PODLE EN442 - 75/65/20°C

pokořová teplota: 20°C

Průměrná N- hodnota 1.36

TA	TR	65	60	55	50	45	40	35	30	25
75	1.00	0.93	0.85	0.77	0.69	0.61	0.52	0.42	0.31	
70	0.94	0.87	0.79	0.72	0.64	0.56	0.48	0.39	0.28	
65		0.80	0.74	0.67	0.60	0.52	0.44	0.35	0.25	
60			0.68	0.61	0.55	0.48	0.40	0.32	0.23	
55				0.56	0.50	0.43	0.36	0.29	0.20	
50					0.44	0.38	0.32	0.25	0.18	
45						0.34	0.28	0.22	0.15	
40							0.24	0.19	0.13	
35								0.15	0.10	
30									0.07	

Průměrné korekční faktory pro Strada (bez DBH). Přesné korekční faktory pro Strada nebo Strada Hybrid: viz nástroje pro výběr (Selection tools).

pokořová teplota: 24°C

Průměrná N- hodnota 1.36

TA	TR	65	60	55	50	45	40	35	30	25
75		0.89	0.82	0.75	0.67	0.59	0.51	0.41	0.31	0.16
70		0.83	0.76	0.69	0.62	0.54	0.47	0.38	0.28	0.14
65			0.70	0.64	0.57	0.50	0.43	0.35	0.25	0.12
60				0.58	0.52	0.45	0.38	0.31	0.23	0.11
55					0.47	0.41	0.34	0.28	0.20	0.09
50						0.36	0.30	0.24	0.17	0.08
45							0.26	0.20	0.14	0.06
40								0.17	0.12	0.05
35									0.09	0.03
30										0.02

SMĚRNICE PRO OMEZOVÁNÍ HLUKU PROUDĚNÍ

TRUBKA	vnější Ø mm	Tloušťka stěny mm	Max. průtok vody (EN10255) m/s	obsah vody na metr l	max. průtok vody kg/h	Maximální výkon při ΔT (° C) (T na přívodu – T na zpátečce)						
						ΔT 30 Watty	ΔT 20 Watty	ΔT 10 Watty	ΔT 5 Watty	ΔT 4 Watty	ΔT 3 Watty	ΔT 2 Watty
GALVA TRUBKA DIN 2440												
3/8 DN10 OD	17.2	2.35	0.40	0.12	173	6028	4019	2009	1005	804	603	402
1/2 DN15 OD	21.3	2.65	0.40	0.20	288	10046	6698	3349	1674	1340	1005	670
3/4 DN20 OD	26.9	2.65	0.42	0.37	559	19515	13010	6505	3253	2602	1952	1301
1 DN25 OD	33.7	3.25	0.49	0.58	1023	35690	23793	11897	5948	4759	3569	2379
1 1/4 DN32 OD	42.4	3.25	0.60	1.01	2182	76101	50734	25367	12684	10147	7610	5073
1 1/2 DN40 OD	48.3	3.25	0.66	1.37	3255	113549	75700	37850	18925	15140	11355	7570
2 DN50 OD	60.3	3.65	0.80	2.21	6365	222025	148017	74008	37004	29603	22203	14802
PRO PŘESNOU OCELOVOU A MĚDĚNOU TRUBKU												
10/1	10	1.00	0.40	0.05	72	2512	1674	837	419	335	251	167
12/1	12	1.00	0.40	0.08	115	4019	2679	1340	670	536	402	268
14/1	14	1.00	0.40	0.11	158	5526	3684	1842	921	737	553	368
15/1	15	1.00	0.40	0.13	187	6530	4353	2177	1088	871	653	435
16/1	16	1.00	0.40	0.15	216	7535	5023	2512	1256	1005	753	502
18/1	18	1.00	0.40	0.20	288	10046	6698	3349	1674	1340	1005	670
22/1	22	1.00	0.40	0.31	446	15572	10381	5191	2595	2076	1557	1038
28/1	28	1.00	0.47	0.53	904	31522	21014	10507	5254	4203	3152	2101
PRO VPE/ALU TRUBKU												
12/2	12	2.00	0.40	0.05	72	2512	1674	837	419	335	251	167
14/2	14	2.00	0.40	0.08	115	4019	2679	1340	670	536	402	268
16/1.5	16	1.50	0.40	0.13	187	6530	4353	2177	1088	871	653	435
16/2	16	2.00	0.40	0.11	158	5526	3684	1842	921	737	553	368
17/2	17	2.00	0.40	0.13	187	6530	4353	2177	1088	871	653	435
18/2	18	2.00	0.40	0.15	216	7535	5023	2512	1256	1005	753	502
20/2	20	2.00	0.40	0.20	288	10046	6698	3349	1674	1340	1005	670
26/3	26	3.00	0.40	0.31	446	15572	10381	5191	2595	2076	1557	1038
32/3	32	3.00	0.47	0.53	904	31522	21014	10507	5254	4203	3152	2101
40/3.5	40	3.50	0.56	0.86	1726	60220	40147	20073	10037	8029	6022	4015
50/4.25	50	4.25	0.66	1.35	3206	111824	74549	37275	18637	14910	11182	7455
63/5	63	5.00	0.80	2.21	6346	221359	147573	73786	36893	29515	22136	14757

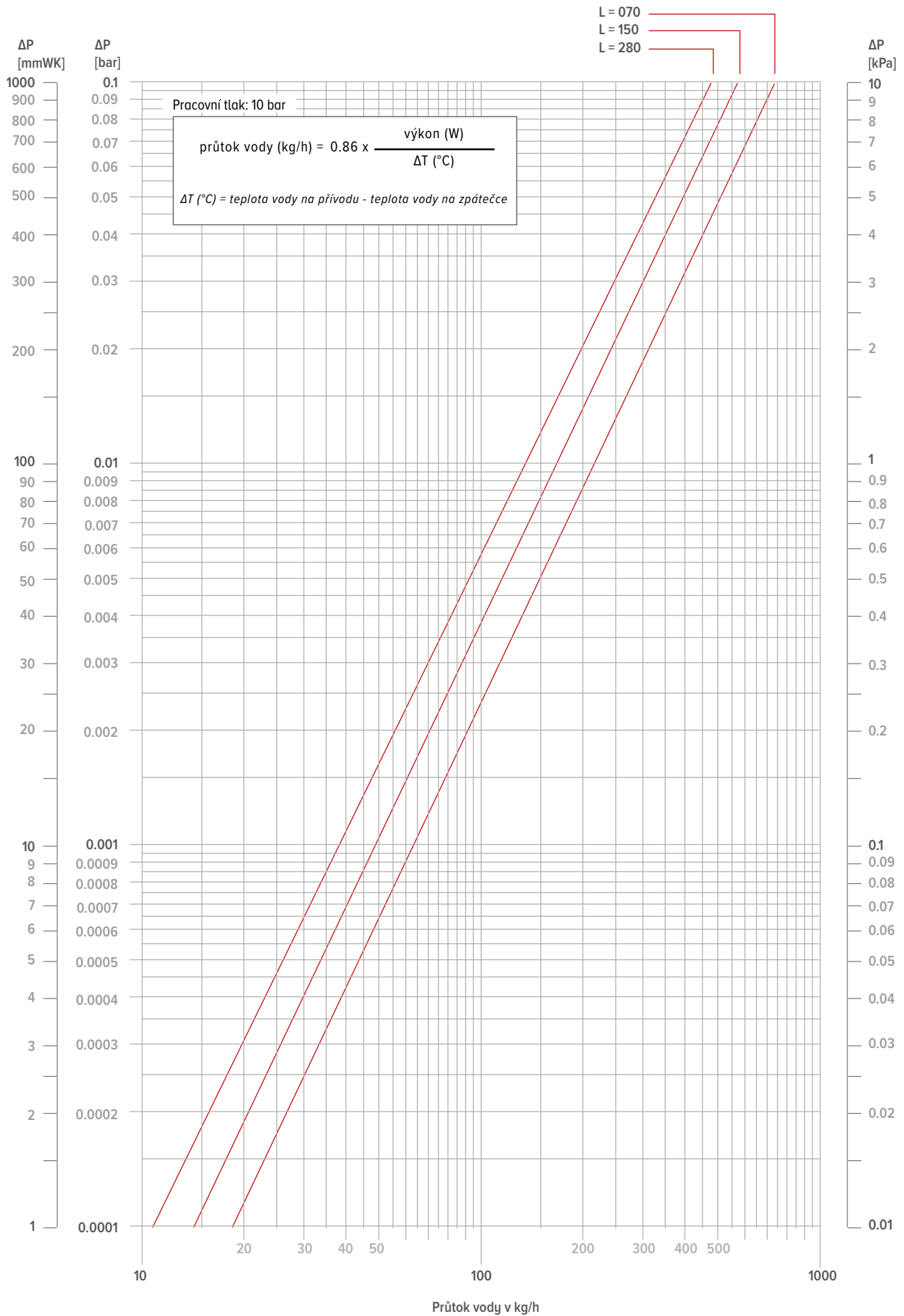

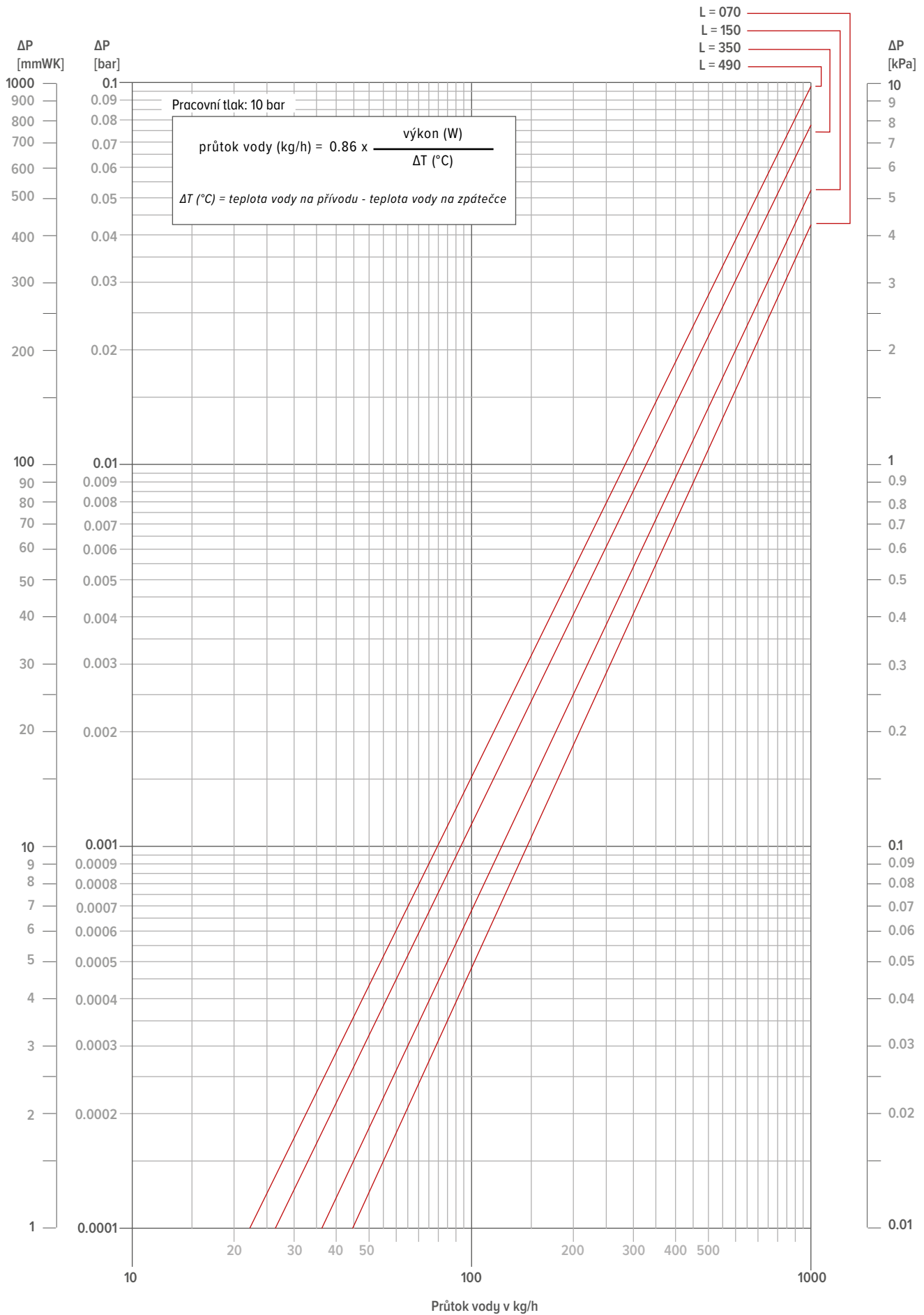

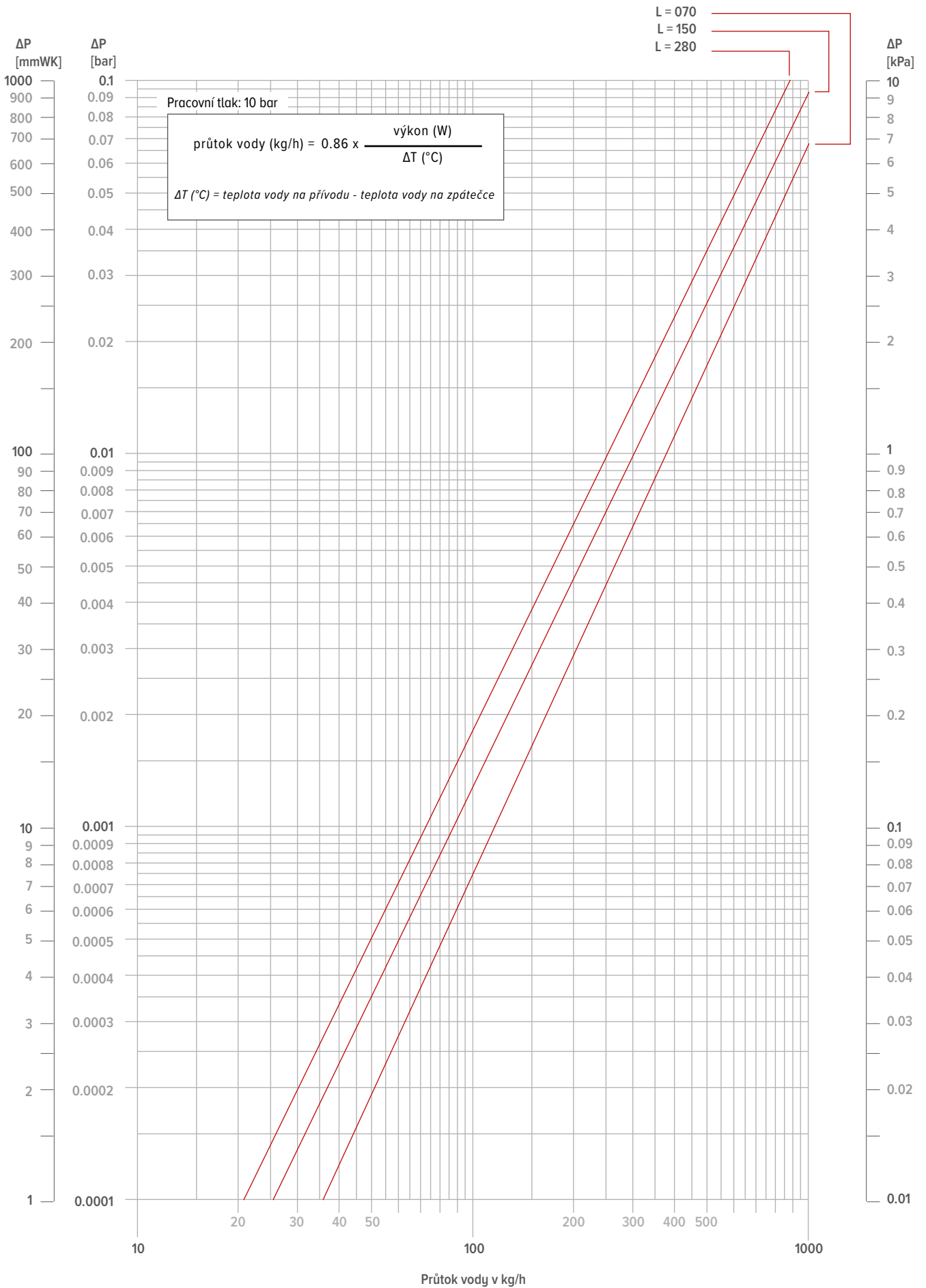

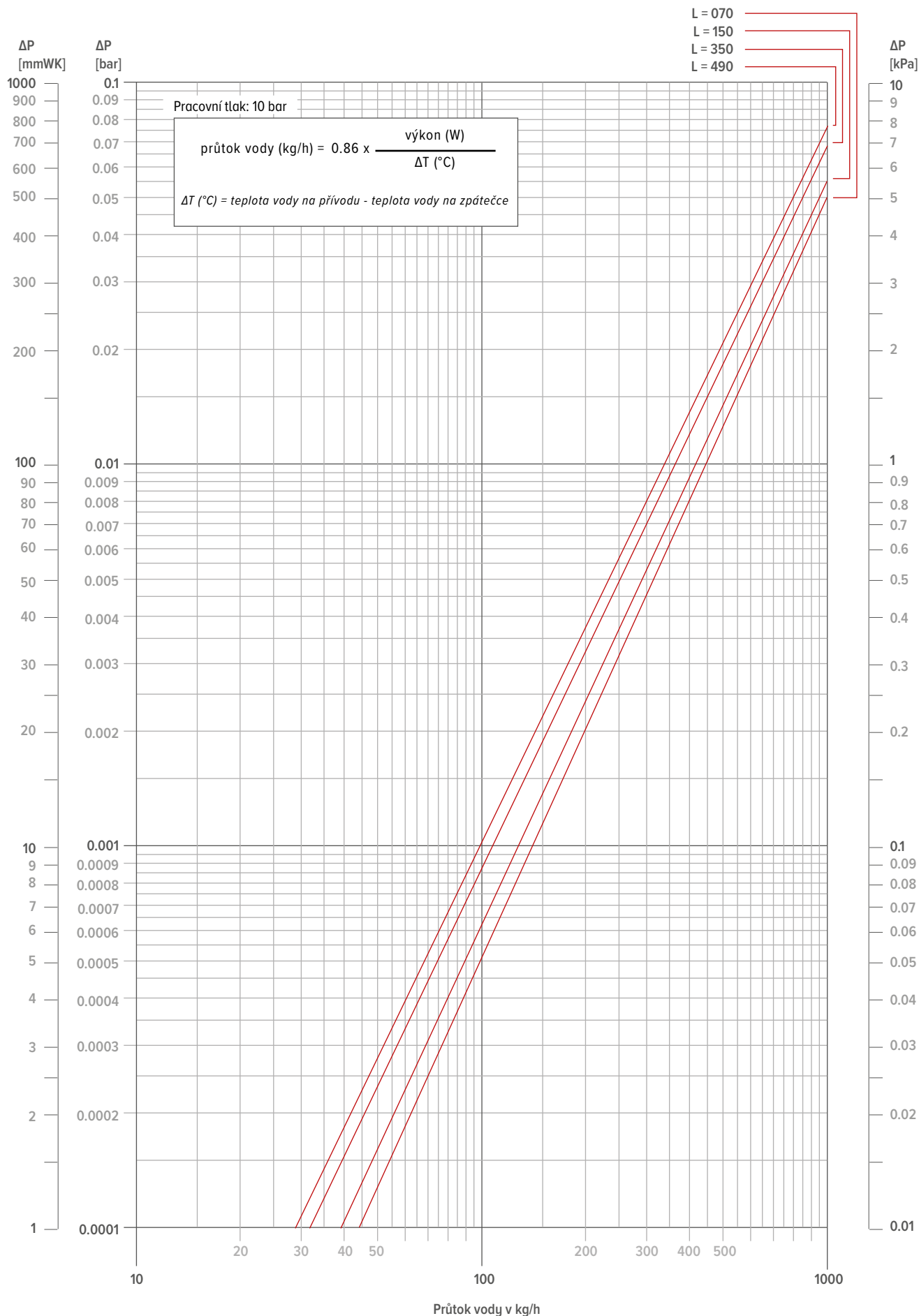

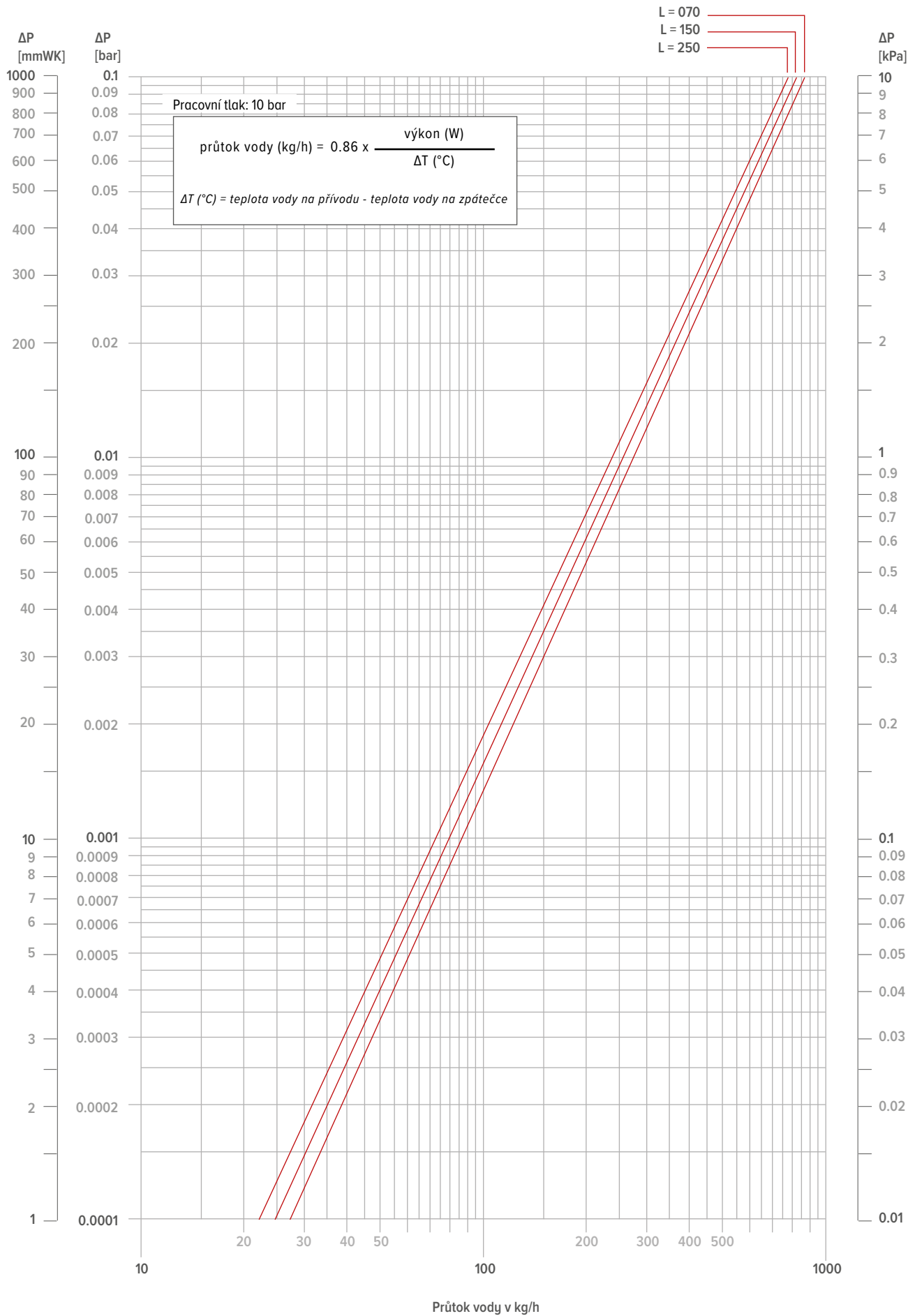

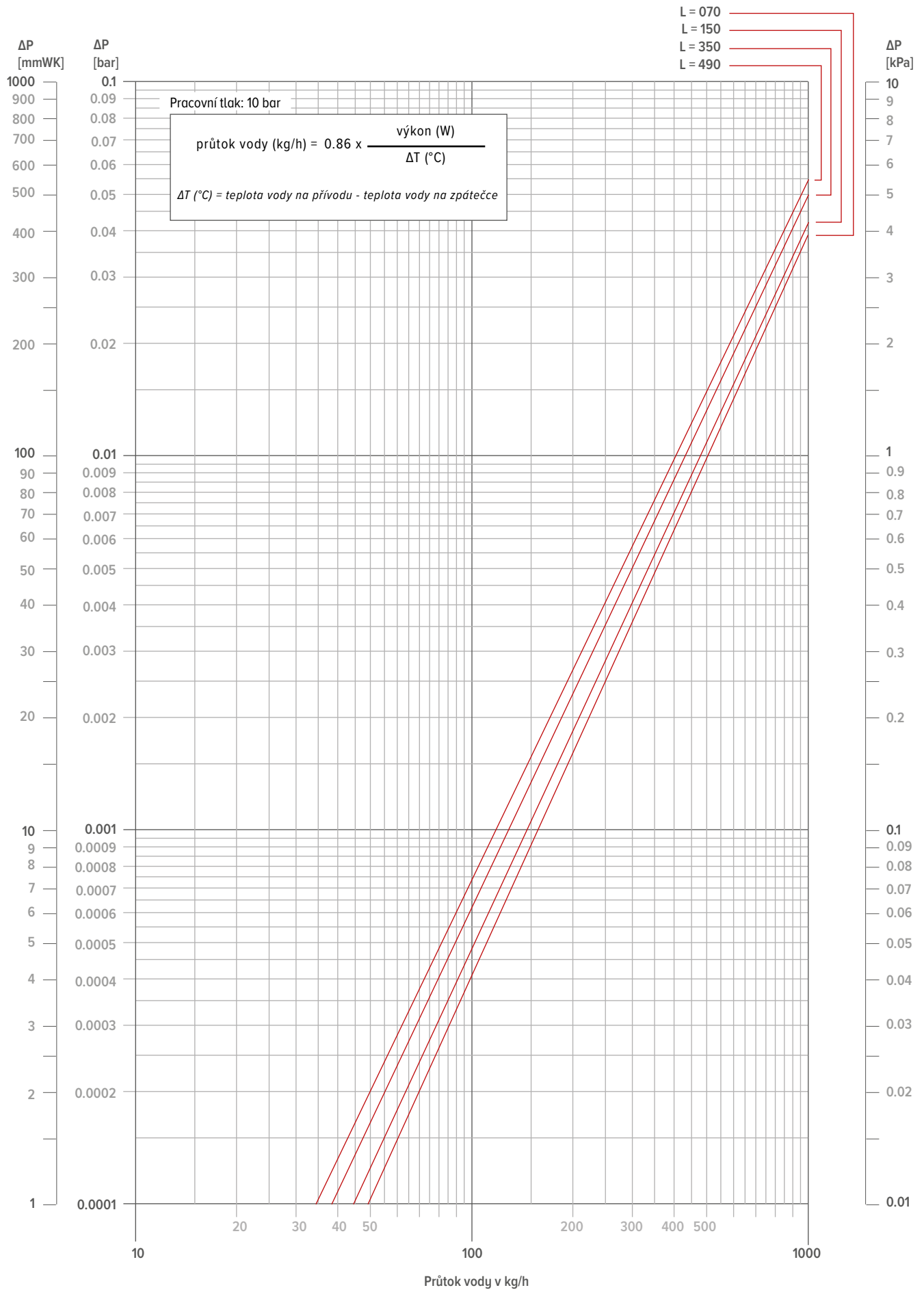

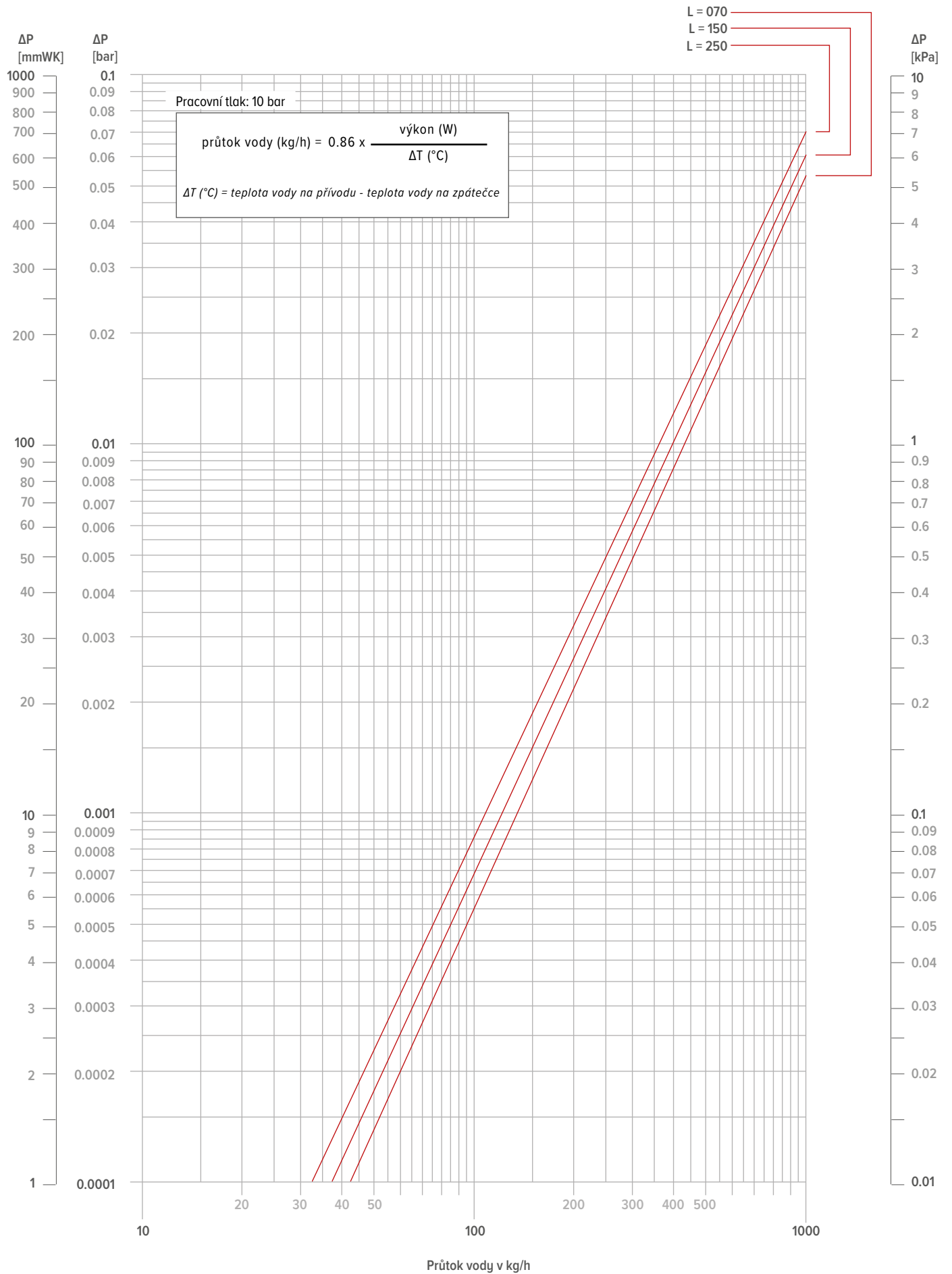



jaga CLIMATE
DESIGNERS

ČESKÁ REPUBLIKA JAGA N.V. - ORGANIZAČNÍ SLOŽKA

Potřebujete poradit? Sjednejte si schůzku v našem Showroomu v Praze Jinonicích.

U Trezorky 921/2
158 00 Praha 5 - Jinonice

Tel.: +420 220 190 516
info@jagacz.com
www.jaga.com

BELGIE JAGA NV

Verbindingslaan 16
3590 Diepenbeek

+32 (0) 11 29 41 11

info@jaga.be
jaga.com