



TEMPO STANDMODELL



TEMPO STANDMODELL

INHALTSVERZEICHNIS	3
TECHNISCHE INFORMATIONEN	4
Abmessungen	4
Standard-Lieferung	5
Farben	5
Optionen	5
Wasserseitiger Anschluss	6
Anschluss links oder rechts mit Bedienung von unten (Standard)	6
Links- oder Rechtsanschluss mit Fernsteuerung	6
Technische Tabelle	7
Höhe 020	7
Höhe 030	8
Höhe 040	10
Höhe 050	12
Einzelteile	14
Korrekturfaktoren	16
Druckverluste	17
Typ 10	17
Typ 11	18
Typ 15	19
Typ 16	20
Typ 20	21
Typ 21	22

TEMPO STANDMODELL

EN 442

30
JAHRE
GARANTIE
WÄRMETAUSCHER

ABMESSUNGEN (in mm)

Höhe 020

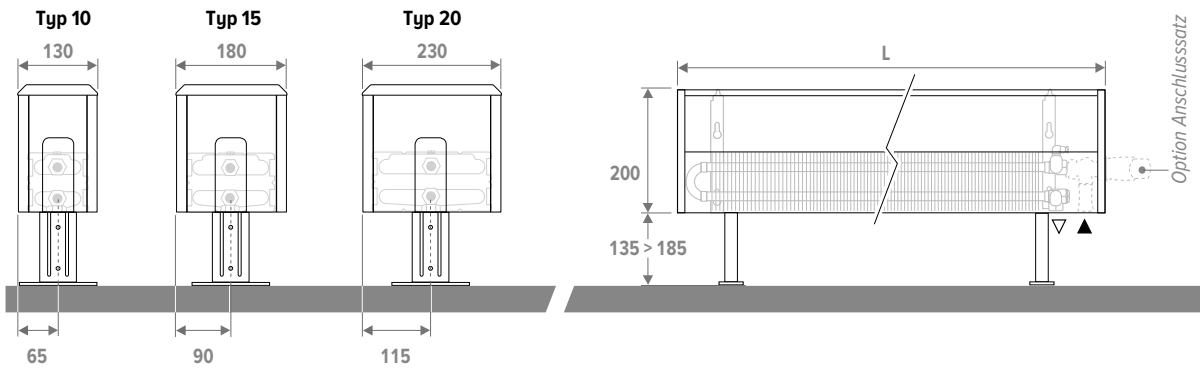

Höhe 030

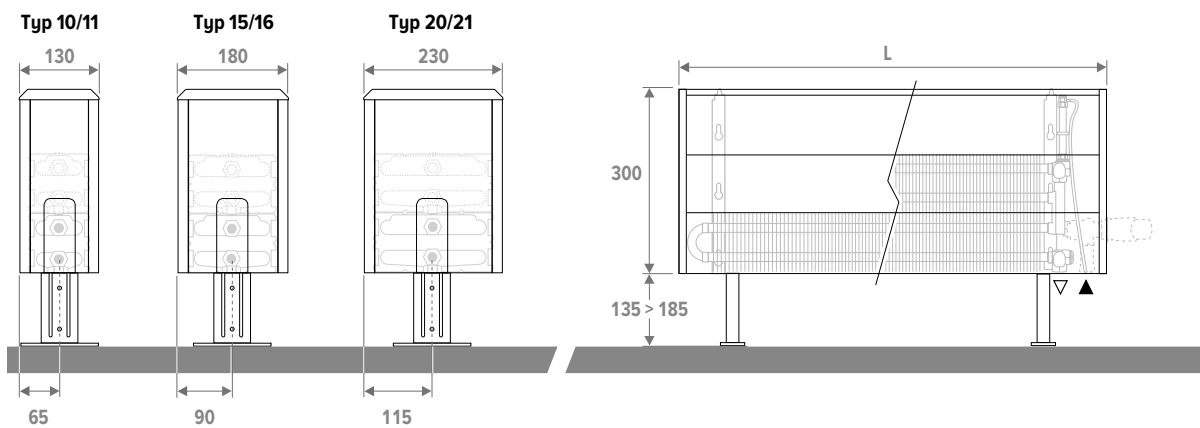

Höhe 040

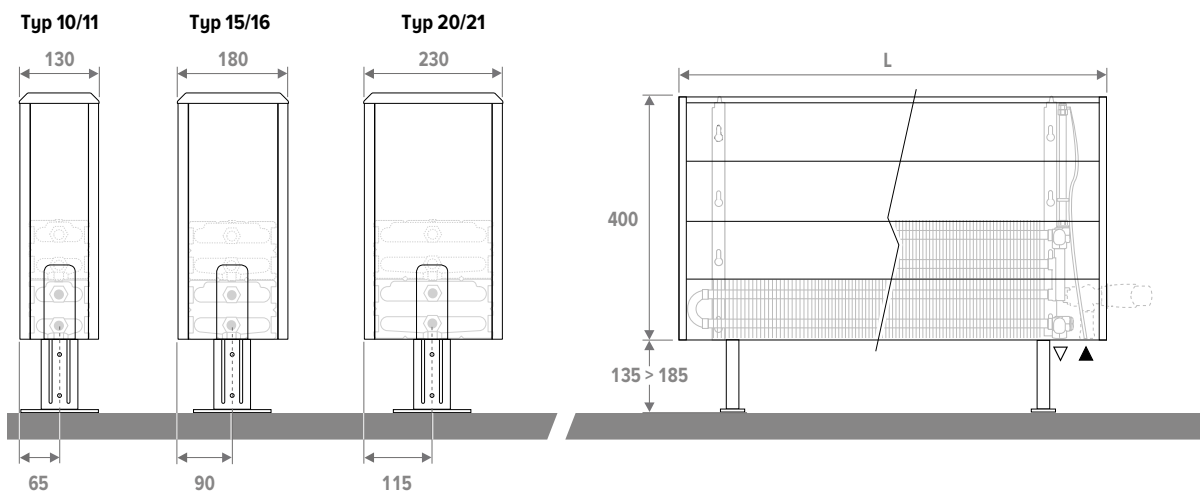

Höhe 050

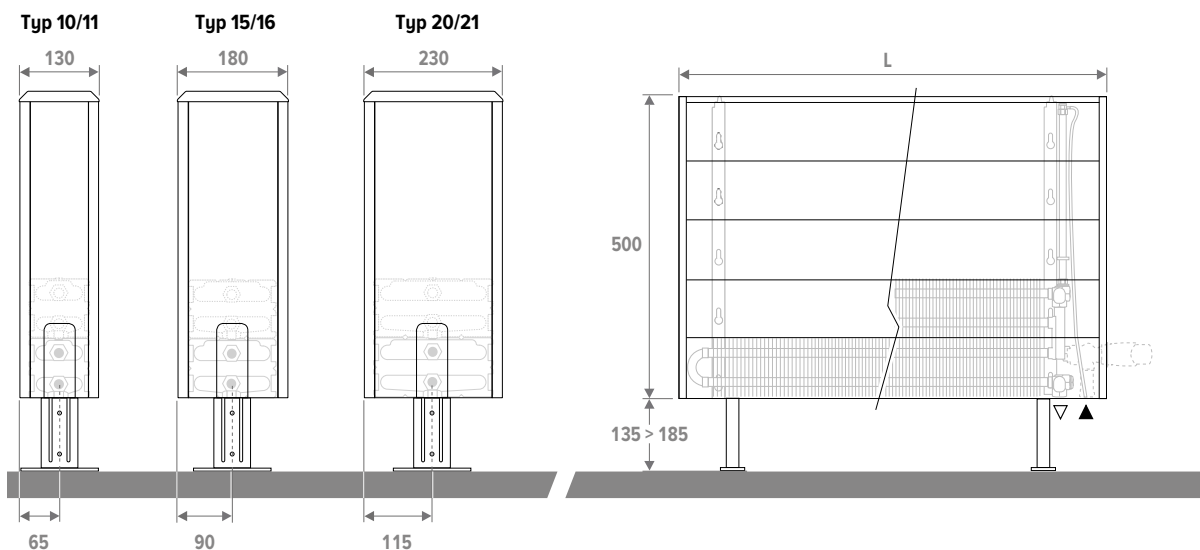

TEMPO STANDMODELL

STANDARD-LIEFERUNG

- Low-H₂O-Wärmetauscher, mit schmutz- und staubabweisender Lackierung in Graphitgrau (RAL 7024)
- Standard verstellbare Fußkonsolen in neutralem Grau
- abgewinkelter Entlüfter (Standard und Höhe 020) oder verlängerter Entlüfter (Twin) 1/8“ und Ablassschraube 1/2“
- Einfach zu montierende Verkleidung mit einer geschlossenen Seite und einer offenen Seite für den Anschluss, austauschbar links oder rechts

STANDARD FARBEN

Umweltfreundlich lackiert mit kratz- und stossfester Oberflächenverkleidung mit hoher UV-Beständigkeit Weiss RAL (9010) 101

OPTIONEN

Füsse in Heizkörperfarbe

Die Füsse werden standard grau lackiert, können aber auch in der Farbe des Heizkörpers lackiert werden. Hierfür den Farbkode zusätzlich mit / an die Artikelnummer anhängen.

z.B.: TEMF HHH LLL TT 101 AS **101**

Aufpreis je nach Länge des Geräts:

- Länge 040 > 120: 2 Füsse
- Länge 140 > 220: 3 Füsse
- Länge 240 > 300: 4 Füsse

Verlängerte regelbare Füße

- Für grau lackierte verlängerte regelbare Füsse, an die Art.-Nr. AL anhängen.

z.B.: TEMF 020 040 10 101 **AL**

- Für verlängerte regelbare Füsse in Heizkörperfarbe, an die Art.-Nr. AL anhängen + Farbkode wiederholen.

z.B.: TEMF 020 040 10 101 **AL 101**

Aufpreis je nach Länge des Geräts:

- Länge 040 > 120: 2 Füsse
- Länge 140 > 220: 3 Füsse
- Länge 240 > 300: 4 Füsse

ARTIKELNUMMER

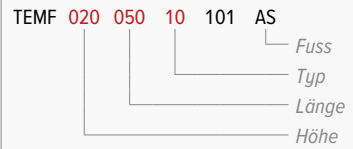

STANDARD: ANSCHLUSS LINKS ODER RECHTS MIT BEDIENUNG VON UNTEN

Links oder rechts unten, an der Wand oder am Boden. Wandanschluss über die Unterseite der Verkleidung oder vollständig unsichtbar innerhalb der Verkleidung. Der Installateur kann den Wärmetauscher für einen rechts- oder linksseitigen Anschluss drehen.

Mögliche Eurokonus-Anschlusssätze: 102, 104, 182, 184, 282

Mögliche M24-Anschlusssätze: 12, 14

Beispiel Anschluss rechts (Standard)

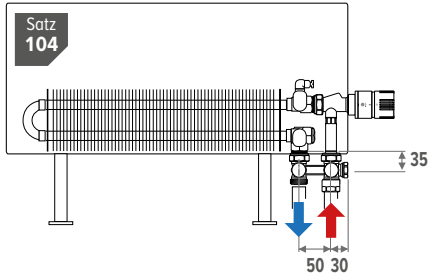

Beispiel Anschluss links

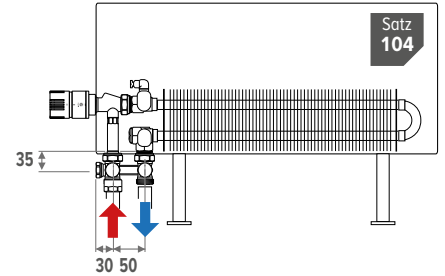

LINKS- ODER RECHTSANSCHLUSS MIT FERNSTEUERUNG

Mögliche Eurokonus-Anschlusssätze: 112, 114

Beispiel Anschluss rechts (Standard)

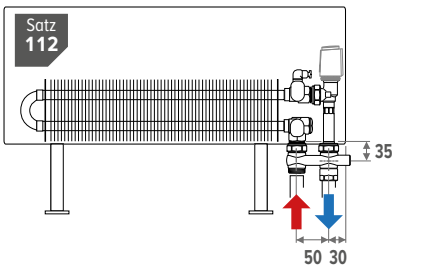

Beispiel Anschluss links

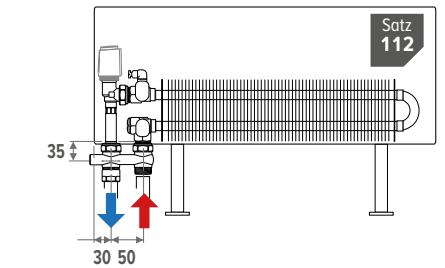

MEIST VERWENDETE ANSCHLUSSSÄTZE

ZUM BODEN - VORLAUF AN DER AUSSENSEITE

Mit Jaga-H-Ventil

Mit Dynamischem Gampper Vario DP-Ventil

ZUM BODEN - VORLAUF AN DER INNENSEITE

Mit Jaga Crossflow-Ventil

Mit Dynamischem Gampper Vario DP-Ventil

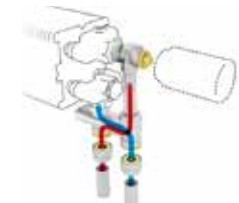
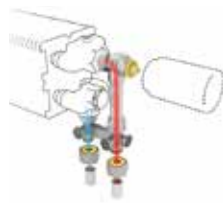

Satz 104 KVS: 0.8
ZWEIROHR / EINROHR

COLO HBSF AC 4...	AC	
COLO HBSF AW 4...	AW	
COLO HBSF AS 4...	AS	
COLO HBSF AB 4...	AB	
COLO HBSF JH 4...	JH	

Kode Klemmringverschraubung angeben

Satz 184 automatische Durchflußregelung (20 -340 L/St)
ZWEIROHR

COLO GASF AC 4...	AC	
COLO GASF AW 4...	AW	
COLO GASF AS 4...	AS	
COLO GASF AB 4...	AB	
COLO GASF JH 4...	JH	

Kode Klemmringverschraubung angeben

Satz 102 KVS: 0.8
ZWEIROHR

COLO HBCF AC 4...	AC	
COLO HBCF AW 4...	AW	
COLO HBCF AS 4...	AS	
COLO HBCF AB 4...	AB	
COLO HBCF JH 4...	JH	

Kode Klemmringverschraubung angeben

Satz 182 automatische Durchflußregelung (20 - 340 L/St)
ZWEIROHR

COLO GACF AC 4...	AC	
COLO GACF AW 4...	AW	
COLO GACF AS 4...	AS	
COLO GACF AB 4...	AB	
COLO GACF JH 4...	JH	

Kode Klemmringverschraubung angeben

Klemmringverschraubungen 3/4" Euro-Konus Außengewinde

PRÄZISIONSMETALLROHR		KUNSTSTOFF ODER VPE/ALU	
KODE	Rohr Ø	KODE	Rohr Ø
112	12/1	612	12/2
114	14/1	614	14/2
115	15/1	616	16/2
116	16/1	618	18/2
118	18/1	619	16/1.5
		620	20/2

Detaillierte Informationen zu den Ventilen, siehe Broschüre „Anschlusssätze & Ventile“.

TEMPO STANDMODELL

HÖHE 020 (STANDARD)

Typ 10

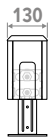

Typ 15

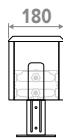

Typ 20

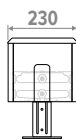

HÖHE H cm	LÄNGE L cm	TYP T	HEIZEN Raumtemperatur 20°C					GEWICHT Kg	WASSERINHALT L	ARTIKELNUMMER
			35/30 Watt	45/40 Watt	50/45 Watt	55/45 Watt	75/65 Watt			
TEMF 020	050	10	46	106	141	158	328		TEMF 020 050 10 101 AS	
		15	76	177	235	263	545		TEMF 020 050 15 101 AS	
		20	107	249	330	370	766		TEMF 020 050 20 101 AS	
060	10	15	55	127	169	189	393		TEMF 020 060 10 101 AS	
		15	92	212	282	316	654		TEMF 020 060 15 101 AS	
		20	129	298	396	444	919		TEMF 020 060 20 101 AS	
070	10	15	64	148	197	221	459		TEMF 020 070 10 101 AS	
		15	107	248	329	369	763		TEMF 020 070 15 101 AS	
		20	150	348	462	518	1072		TEMF 020 070 20 101 AS	
080	10	15	73	169	225	252	524		TEMF 020 080 10 101 AS	
		15	122	283	376	421	872		TEMF 020 080 15 101 AS	
		20	172	398	529	592	1226		TEMF 020 080 20 101 AS	
090	10	15	82	191	254	284	590		TEMF 020 090 10 101 AS	
		15	137	318	423	474	981		TEMF 020 090 15 101 AS	
		20	193	448	595	666	1379		TEMF 020 090 20 101 AS	
100	10	15	91	212	282	316	655		TEMF 020 100 10 101 AS	
		15	153	354	470	526	1090		TEMF 020 100 15 101 AS	
		20	214	497	661	740	1532		TEMF 020 100 20 101 AS	
110	10	15	100	233	310	347	721		TEMF 020 110 10 101 AS	
		15	168	389	517	579	1199		TEMF 020 110 15 101 AS	
		20	236	547	727	814	1685		TEMF 020 110 20 101 AS	
120	10	15	109	254	338	379	786		TEMF 020 120 10 101 AS	
		15	183	424	564	632	1308		TEMF 020 120 15 101 AS	
		20	257	596	793	888	1838		TEMF 020 120 20 101 AS	
140	10	15	127	296	394	442	917		TEMF 020 140 10 101 AS	
		15	214	495	658	737	1526		TEMF 020 140 15 101 AS	
		20	300	696	925	1036	2145		TEMF 020 140 20 101 AS	
160	10	15	146	339	451	505	1048		TEMF 020 160 10 101 AS	
		15	244	566	752	842	1744		TEMF 020 160 15 101 AS	
		20	343	795	1057	1184	2451		TEMF 020 160 20 101 AS	
180	10	15	164	381	507	568	1179		TEMF 020 180 10 101 AS	
		15	275	637	846	948	1962		TEMF 020 180 15 101 AS	
		20	386	895	1190	1332	2758		TEMF 020 180 20 101 AS	
200	10	15	182	423	563	631	1310		TEMF 020 200 10 101 AS	
		15	305	707	940	1053	2180		TEMF 020 200 15 101 AS	
		20	429	994	1322	1480	3064		TEMF 020 200 20 101 AS	
220	10	15	200	466	620	694	1441		TEMF 020 220 10 101 AS	
		15	336	778	1034	1158	2398		TEMF 020 220 15 101 AS	
		20	472	1094	1454	1628	3370		TEMF 020 220 20 101 AS	
240	10	15	219	508	676	757	1572		TEMF 020 240 10 101 AS	
		15	366	849	1128	1264	2616		TEMF 020 240 15 101 AS	
		20	515	1193	1586	1776	3677		TEMF 020 240 20 101 AS	
260	10	15	237	550	732	820	1703		TEMF 020 260 10 101 AS	
		15	397	920	1222	1369	2834		TEMF 020 260 15 101 AS	
		20	558	1293	1718	1924	3983		TEMF 020 260 20 101 AS	
280	10	15	255	593	789	884	1834		TEMF 020 280 10 101 AS	
		15	427	990	1316	1474	3052		TEMF 020 280 15 101 AS	
		20	600	1392	1850	2072	4290		TEMF 020 280 20 101 AS	
300	10	15	273	635	845	947	1965		TEMF 020 300 10 101 AS	
		15	458	1061	1410	1579	3270		TEMF 020 300 15 101 AS	
		20	643	1491	1982	2220	4596		TEMF 020 300 20 101 AS	

Abgabe nach EN442 bei 20°C

TEMPO STANDMODELL

HÖHE 030 (STANDARD)

Typ 10



Typ 15

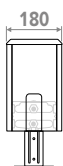

Typ 20

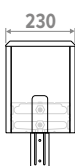

HÖHE H cm	LÄNGE L cm	TYP T	HEIZEN Raumtemperatur 20°C					GEWICHT Kg	WASSERINHALT L	ARTIKELNUMMER
			35/30 Watt	45/40 Watt	50/45 Watt	55/45 Watt	75/65 Watt			
TEMF 030	050	10	58	135	179	200	413		TEMF 030 050 10 101 AS	
		15	97	223	295	330	680		TEMF 030 050 15 101 AS	
		20	136	312	414	463	953		TEMF 030 050 20 101 AS	
060	10	10	70	162	215	240	496		TEMF 030 060 10 101 AS	
		15	116	267	354	396	815		TEMF 030 060 15 101 AS	
		20	163	375	497	556	1144		TEMF 030 060 20 101 AS	
070	10	10	81	188	250	280	578		TEMF 030 070 10 101 AS	
		15	135	312	413	462	951		TEMF 030 070 15 101 AS	
		20	190	437	580	648	1334		TEMF 030 070 20 101 AS	
080	10	10	93	215	286	320	661		TEMF 030 080 10 101 AS	
		15	155	356	472	528	1087		TEMF 030 080 15 101 AS	
		20	217	500	662	741	1525		TEMF 030 080 20 101 AS	
090	10	10	105	242	321	360	743		TEMF 030 090 10 101 AS	
		15	174	401	531	594	1223		TEMF 030 090 15 101 AS	
		20	244	562	745	834	1715		TEMF 030 090 20 101 AS	
100	10	10	116	269	357	400	826		TEMF 030 100 10 101 AS	
		15	193	445	590	660	1359		TEMF 030 100 15 101 AS	
		20	271	624	828	926	1906		TEMF 030 100 20 101 AS	
110	10	10	128	296	393	440	909		TEMF 030 110 10 101 AS	
		15	213	490	649	727	1495		TEMF 030 110 15 101 AS	
		20	298	687	911	1019	2097		TEMF 030 110 20 101 AS	
120	10	10	140	323	429	480	991		TEMF 030 120 10 101 AS	
		15	232	534	709	793	1631		TEMF 030 120 15 101 AS	
		20	326	749	993	1112	2287		TEMF 030 120 20 101 AS	
140	10	10	163	377	500	560	1156		TEMF 030 140 10 101 AS	
		15	271	624	827	925	1903		TEMF 030 140 15 101 AS	
		20	380	874	1159	1297	2668		TEMF 030 140 20 101 AS	
160	10	10	186	431	572	640	1322		TEMF 030 160 10 101 AS	
		15	309	712	944	1057	2174		TEMF 030 160 15 101 AS	
		20	434	999	1325	1482	3050		TEMF 030 160 20 101 AS	
180	10	10	210	484	643	720	1487		TEMF 030 180 10 101 AS	
		15	348	801	1063	1189	2446		TEMF 030 180 15 101 AS	
		20	488	1124	1490	1668	3431		TEMF 030 180 20 101 AS	
200	10	10	233	538	715	800	1652		TEMF 030 200 10 101 AS	
		15	387	891	1181	1321	2718		TEMF 030 200 15 101 AS	
		20	543	1249	1656	1853	3812		TEMF 030 200 20 101 AS	
220	10	10	256	592	786	880	1817		TEMF 030 220 10 101 AS	
		15	426	980	1299	1453	2990		TEMF 030 220 15 101 AS	
		20	597	1374	1821	2038	4193		TEMF 030 220 20 101 AS	
240	10	10	279	646	857	960	1982		TEMF 030 240 10 101 AS	
		15	464	1069	1417	1585	3262		TEMF 030 240 15 101 AS	
		20	651	1499	1987	2223	4574		TEMF 030 240 20 101 AS	
260	10	10	303	700	929	1040	2148		TEMF 030 260 10 101 AS	
		15	503	1158	1535	1717	3533		TEMF 030 260 15 101 AS	
		20	705	1624	2153	2409	4956		TEMF 030 260 20 101 AS	
280	10	10	326	754	1001	1120	2313		TEMF 030 280 10 101 AS	
		15	542	1247	1653	1849	3805		TEMF 030 280 15 101 AS	
		20	760	1749	2318	2594	5337		TEMF 030 280 20 101 AS	
300	10	10	349	807	1072	1200	2478		TEMF 030 300 10 101 AS	
		15	580	1336	1771	1981	4077		TEMF 030 300 15 101 AS	
		20	814	1873	2484	2779	5718		TEMF 030 300 20 101 AS	

Abgabe nach EN442 bei 20°C

TEMPO STANDMODELL

HÖHE 030 (TWIN)

Typ 11

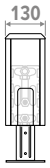

Typ 16

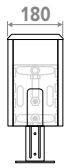

Typ 21

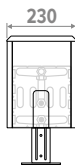

HÖHE H cm	LÄNGE L cm	TYP T	HEIZEN Raumtemperatur 20°C					GEWICHT Kg	WASSERINHALT L	ARTIKELNUMMER
			35/30 Watt	45/40 Watt	50/45 Watt	55/45 Watt	75/65 Watt			
TEMF 030 050		11	75	177	237	267	561		TEMF 030 050 11 101 AS	
		16	97	231	310	349	740		TEMF 030 050 16 101 AS	
		21	125	301	405	456	974		TEMF 030 050 21 101 AS	
060		11	90	213	285	320	673		TEMF 030 060 11 101 AS	
		16	116	277	372	418	888		TEMF 030 060 16 101 AS	
		21	150	362	486	547	1169		TEMF 030 060 21 101 AS	
070		11	105	248	332	373	785		TEMF 030 070 11 101 AS	
		16	136	324	434	488	1036		TEMF 030 070 16 101 AS	
		21	176	422	568	639	1364		TEMF 030 070 21 101 AS	
080		11	120	284	380	426	897		TEMF 030 080 11 101 AS	
		16	155	370	496	558	1184		TEMF 030 080 16 101 AS	
		21	201	482	648	730	1558		TEMF 030 080 21 101 AS	
090		11	135	319	427	479	1009		TEMF 030 090 11 101 AS	
		16	174	416	558	628	1332		TEMF 030 090 16 101 AS	
		21	226	542	729	821	1753		TEMF 030 090 21 101 AS	
100		11	150	355	474	533	1121		TEMF 030 100 11 101 AS	
		16	194	462	620	697	1480		TEMF 030 100 16 101 AS	
		21	251	603	811	912	1948		TEMF 030 100 21 101 AS	
110		11	165	390	522	586	1233		TEMF 030 110 11 101 AS	
		16	213	508	682	767	1628		TEMF 030 110 16 101 AS	
		21	276	663	892	1003	2143		TEMF 030 110 21 101 AS	
120		11	180	425	569	639	1345		TEMF 030 120 11 101 AS	
		16	232	555	744	837	1776		TEMF 030 120 16 101 AS	
		21	301	723	973	1095	2338		TEMF 030 120 21 101 AS	
140		11	210	496	664	745	1569		TEMF 030 140 11 101 AS	
		16	271	647	868	976	2072		TEMF 030 140 16 101 AS	
		21	351	844	1135	1277	2727		TEMF 030 140 21 101 AS	
160		11	240	567	759	852	1794		TEMF 030 160 11 101 AS	
		16	310	740	992	1116	2368		TEMF 030 160 16 101 AS	
		21	401	964	1297	1460	3117		TEMF 030 160 21 101 AS	
180		11	270	638	854	959	2018		TEMF 030 180 11 101 AS	
		16	349	832	1117	1255	2664		TEMF 030 180 16 101 AS	
		21	451	1084	1459	1642	3506		TEMF 030 180 21 101 AS	
200		11	300	709	949	1065	2242		TEMF 030 200 11 101 AS	
		16	387	924	1241	1395	2960		TEMF 030 200 16 101 AS	
		21	502	1205	1621	1824	3896		TEMF 030 200 21 101 AS	
220		11	330	780	1043	1172	2466		TEMF 030 220 11 101 AS	
		16	426	1017	1365	1534	3256		TEMF 030 220 16 101 AS	
		21	552	1326	1784	2007	4286		TEMF 030 220 21 101 AS	
240		11	360	851	1138	1278	2690		TEMF 030 240 11 101 AS	
		16	465	1109	1489	1674	3552		TEMF 030 240 16 101 AS	
		21	602	1446	1945	2189	4675		TEMF 030 240 21 101 AS	
260		11	390	922	1233	1385	2915		TEMF 030 260 11 101 AS	
		16	504	1202	1613	1813	3848		TEMF 030 260 16 101 AS	
		21	652	1567	2108	2372	5065		TEMF 030 260 21 101 AS	
280		11	420	993	1328	1491	3139		TEMF 030 280 11 101 AS	
		16	542	1294	1737	1953	4144		TEMF 030 280 16 101 AS	
		21	702	1687	2270	2554	5454		TEMF 030 280 21 101 AS	
300		11	450	1064	1423	1598	3363		TEMF 030 300 11 101 AS	
		16	581	1387	1861	2092	4440		TEMF 030 300 16 101 AS	
		21	752	1808	2432	2736	5844		TEMF 030 300 21 101 AS	

Abgabe nach EN442 bei 20°C

TEMPO STANDMODELL

HÖHE 040 (STANDARD)

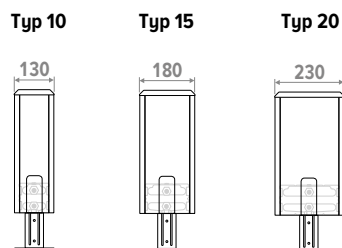

HÖHE H cm	LÄNGE L cm	TYP T	HEIZEN Raumtemperatur 20°C					GEWICHT Kg	WASSERINHALT L	ARTIKELNUMMER
			35/30 Watt	45/40 Watt	50/45 Watt	55/45 Watt	75/65 Watt			
TEMF 040	050	10	69	158	210	234	482		TEMF 040 050 10 101 AS	
		15	113	259	343	383	784		TEMF 040 050 15 101 AS	
		20	159	363	480	537	1098		TEMF 040 050 20 101 AS	
060	10	10	83	190	251	281	578		TEMF 040 060 10 101 AS	
		15	136	311	411	460	941		TEMF 040 060 15 101 AS	
		20	191	436	577	645	1318		TEMF 040 060 20 101 AS	
070	10	10	96	221	293	328	674		TEMF 040 070 10 101 AS	
		15	159	363	480	537	1098		TEMF 040 070 15 101 AS	
		20	222	508	672	752	1537		TEMF 040 070 20 101 AS	
080	10	10	110	253	335	375	770		TEMF 040 080 10 101 AS	
		15	181	414	548	613	1254		TEMF 040 080 15 101 AS	
		20	254	581	769	859	1757		TEMF 040 080 20 101 AS	
090	10	10	124	285	377	422	867		TEMF 040 090 10 101 AS	
		15	204	466	617	690	1411		TEMF 040 090 15 101 AS	
		20	286	654	865	966	1976		TEMF 040 090 20 101 AS	
100	10	10	137	316	419	469	963		TEMF 040 100 10 101 AS	
		15	227	518	686	766	1568		TEMF 040 100 15 101 AS	
		20	318	726	961	1074	2196		TEMF 040 100 20 101 AS	
110	10	10	151	348	461	515	1059		TEMF 040 110 10 101 AS	
		15	249	570	754	843	1725		TEMF 040 110 15 101 AS	
		20	350	799	1057	1182	2416		TEMF 040 110 20 101 AS	
120	10	10	165	379	503	562	1156		TEMF 040 120 10 101 AS	
		15	272	622	823	920	1882		TEMF 040 120 15 101 AS	
		20	381	872	1153	1289	2635		TEMF 040 120 20 101 AS	
140	10	10	192	442	586	656	1348		TEMF 040 140 10 101 AS	
		15	317	726	960	1073	2195		TEMF 040 140 15 101 AS	
		20	445	1017	1345	1503	3074		TEMF 040 140 20 101 AS	
160	10	10	220	506	670	750	1541		TEMF 040 160 10 101 AS	
		15	363	829	1097	1226	2509		TEMF 040 160 15 101 AS	
		20	509	1162	1537	1718	3514		TEMF 040 160 20 101 AS	
180	10	10	247	569	754	843	1733		TEMF 040 180 10 101 AS	
		15	408	933	1234	1379	2822		TEMF 040 180 15 101 AS	
		20	572	1308	1730	1933	3953		TEMF 040 180 20 101 AS	
200	10	10	275	632	838	937	1926		TEMF 040 200 10 101 AS	
		15	453	1037	1371	1533	3136		TEMF 040 200 15 101 AS	
		20	636	1453	1922	2148	4392		TEMF 040 200 20 101 AS	
220	10	10	302	695	922	1031	2119		TEMF 040 220 10 101 AS	
		15	499	1140	1509	1686	3450		TEMF 040 220 15 101 AS	
		20	699	1598	2114	2363	4831		TEMF 040 220 20 101 AS	
240	10	10	330	758	1005	1124	2311		TEMF 040 240 10 101 AS	
		15	544	1244	1645	1839	3763		TEMF 040 240 15 101 AS	
		20	763	1743	2306	2577	5270		TEMF 040 240 20 101 AS	
260	10	10	357	822	1089	1218	2504		TEMF 040 260 10 101 AS	
		15	589	1348	1783	1993	4077		TEMF 040 260 15 101 AS	
		20	826	1889	2498	2792	5710		TEMF 040 260 20 101 AS	
280	10	10	385	885	1173	1312	2696		TEMF 040 280 10 101 AS	
		15	635	1451	1920	2146	4390		TEMF 040 280 15 101 AS	
		20	890	2034	2690	3007	6149		TEMF 040 280 20 101 AS	
300	10	10	412	948	1257	1406	2889		TEMF 040 300 10 101 AS	
		15	680	1555	2057	2299	4704		TEMF 040 300 15 101 AS	
		20	954	2179	2882	3222	6588		TEMF 040 300 20 101 AS	

Abgabe nach EN442 bei 20°C

TEMPO STANDMODELL

HÖHE 040 (TWIN)

Typ 11

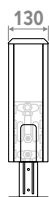

Typ 16

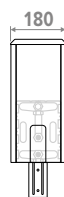

Typ 21

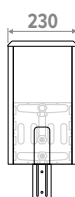

HÖHE H cm	LÄNGE L cm	TYP T	HEIZEN Raumtemperatur 20°C					GEWICHT Kg	WASSERINHALT L	ARTIKELNUMMER
			35/30 Watt	45/40 Watt	50/45 Watt	55/45 Watt	75/65 Watt			
TEMF 040 050	11	11	85	200	268	300	632		TEMF 040 050 11 101 AS	
	16	11	111	265	355	400	850		TEMF 040 050 16 101 AS	
	21	11	145	349	471	530	1137		TEMF 040 050 21 101 AS	
060	11	11	102	240	321	360	758		TEMF 040 060 11 101 AS	
	16	11	133	318	426	480	1020		TEMF 040 060 16 101 AS	
	21	11	173	419	565	636	1364		TEMF 040 060 21 101 AS	
070	11	11	119	280	375	421	885		TEMF 040 070 11 101 AS	
	16	11	155	370	498	560	1190		TEMF 040 070 16 101 AS	
	21	11	202	489	659	742	1592		TEMF 040 070 21 101 AS	
080	11	11	136	320	428	481	1011		TEMF 040 080 11 101 AS	
	16	11	177	423	569	639	1360		TEMF 040 080 16 101 AS	
	21	11	231	559	753	848	1819		TEMF 040 080 21 101 AS	
090	11	11	153	360	482	541	1138		TEMF 040 090 11 101 AS	
	16	11	199	476	640	719	1530		TEMF 040 090 16 101 AS	
	21	11	260	629	847	954	2047		TEMF 040 090 21 101 AS	
100	11	11	169	400	535	601	1264		TEMF 040 100 11 101 AS	
	16	11	221	529	711	799	1700		TEMF 040 100 16 101 AS	
	21	11	289	698	941	1060	2274		TEMF 040 100 21 101 AS	
110	11	11	186	440	589	661	1390		TEMF 040 110 11 101 AS	
	16	11	243	582	782	879	1870		TEMF 040 110 16 101 AS	
	21	11	318	768	1035	1166	2501		TEMF 040 110 21 101 AS	
120	11	11	203	480	642	721	1517		TEMF 040 120 11 101 AS	
	16	11	266	635	853	959	2040		TEMF 040 120 16 101 AS	
	21	11	347	838	1130	1272	2729		TEMF 040 120 21 101 AS	
140	11	11	237	560	749	841	1770		TEMF 040 140 11 101 AS	
	16	11	310	741	995	1119	2380		TEMF 040 140 16 101 AS	
	21	11	405	978	1318	1484	3184		TEMF 040 140 21 101 AS	
160	11	11	271	640	856	961	2022		TEMF 040 160 11 101 AS	
	16	11	354	847	1137	1279	2720		TEMF 040 160 16 101 AS	
	21	11	462	1117	1506	1696	3638		TEMF 040 160 21 101 AS	
180	11	11	305	720	963	1081	2275		TEMF 040 180 11 101 AS	
	16	11	398	953	1279	1439	3060		TEMF 040 180 16 101 AS	
	21	11	520	1257	1694	1908	4093		TEMF 040 180 21 101 AS	
200	11	11	339	800	1070	1202	2528		TEMF 040 200 11 101 AS	
	16	11	443	1058	1422	1599	3400		TEMF 040 200 16 101 AS	
	21	11	578	1397	1882	2120	4548		TEMF 040 200 21 101 AS	
220	11	11	373	880	1177	1322	2781		TEMF 040 220 11 101 AS	
	16	11	487	1164	1564	1759	3740		TEMF 040 220 16 101 AS	
	21	11	636	1536	2071	2332	5003		TEMF 040 220 21 101 AS	
240	11	11	407	960	1285	1442	3034		TEMF 040 240 11 101 AS	
	16	11	531	1270	1706	1918	4080		TEMF 040 240 16 101 AS	
	21	11	694	1676	2259	2544	5458		TEMF 040 240 21 101 AS	
260	11	11	440	1040	1391	1562	3286		TEMF 040 260 11 101 AS	
	16	11	575	1376	1848	2078	4420		TEMF 040 260 16 101 AS	
	21	11	752	1816	2447	2755	5912		TEMF 040 260 21 101 AS	
280	11	11	474	1120	1498	1682	3539		TEMF 040 280 11 101 AS	
	16	11	620	1482	1990	2238	4760		TEMF 040 280 16 101 AS	
	21	11	809	1955	2635	2968	6367		TEMF 040 280 21 101 AS	
300	11	11	508	1200	1606	1802	3792		TEMF 040 300 11 101 AS	
	16	11	664	1588	2132	2398	5100		TEMF 040 300 16 101 AS	
	21	11	867	2095	2824	3180	6822		TEMF 040 300 21 101 AS	

Abgabe nach EN442 bei 20°C

TEMPO STANDMODELL

HÖHE 050 (STANDARD)

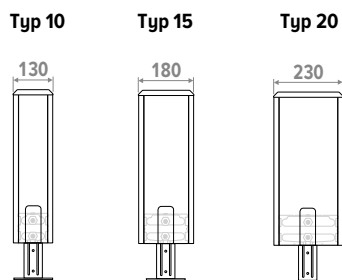

HÖHE H cm	LÄNGE L cm	TYP T	HEIZEN Raumtemperatur 20°C					GEWICHT Kg	WASSERINHALT L	ARTIKELNUMMER
			35/30 Watt	45/40 Watt	50/45 Watt	55/45 Watt	75/65 Watt			
TEMF 050	050	10	78	178	235	263	538		TEMF 050 050 10 101 AS	
		15	127	289	382	426	867		TEMF 050 050 15 101 AS	
		20	178	405	534	597	1213		TEMF 050 050 20 101 AS	
060	10	10	93	214	282	316	646		TEMF 050 060 10 101 AS	
		15	153	347	458	511	1040		TEMF 050 060 15 101 AS	
		20	214	486	641	716	1455		TEMF 050 060 20 101 AS	
070	10	10	109	249	329	368	753		TEMF 050 070 10 101 AS	
		15	178	405	535	597	1214		TEMF 050 070 15 101 AS	
		20	250	567	748	835	1698		TEMF 050 070 20 101 AS	
080	10	10	124	285	376	421	861		TEMF 050 080 10 101 AS	
		15	204	463	611	682	1387		TEMF 050 080 15 101 AS	
		20	285	647	854	954	1940		TEMF 050 080 20 101 AS	
090	10	10	140	320	423	473	968		TEMF 050 090 10 101 AS	
		15	229	521	687	768	1561		TEMF 050 090 15 101 AS	
		20	321	729	961	1074	2183		TEMF 050 090 20 101 AS	
100	10	10	156	356	471	526	1076		TEMF 050 100 10 101 AS	
		15	255	579	764	853	1734		TEMF 050 100 15 101 AS	
		20	356	809	1068	1193	2425		TEMF 050 100 20 101 AS	
110	10	10	171	391	518	579	1184		TEMF 050 110 10 101 AS	
		15	280	636	840	938	1907		TEMF 050 110 15 101 AS	
		20	392	890	1175	1312	2668		TEMF 050 110 20 101 AS	
120	10	10	187	427	565	631	1291		TEMF 050 120 10 101 AS	
		15	306	694	917	1023	2081		TEMF 050 120 15 101 AS	
		20	428	971	1282	1431	2910		TEMF 050 120 20 101 AS	
140	10	10	218	498	659	736	1506		TEMF 050 140 10 101 AS	
		15	357	810	1069	1194	2428		TEMF 050 140 15 101 AS	
		20	499	1133	1495	1670	3395		TEMF 050 140 20 101 AS	
160	10	10	249	569	753	842	1722		TEMF 050 160 10 101 AS	
		15	408	926	1222	1364	2774		TEMF 050 160 15 101 AS	
		20	570	1295	1709	1908	3880		TEMF 050 160 20 101 AS	
180	10	10	280	640	847	947	1937		TEMF 050 180 10 101 AS	
		15	459	1042	1375	1535	3121		TEMF 050 180 15 101 AS	
		20	642	1457	1922	2147	4365		TEMF 050 180 20 101 AS	
200	10	10	311	711	941	1052	2152		TEMF 050 200 10 101 AS	
		15	510	1157	1527	1706	3468		TEMF 050 200 15 101 AS	
		20	713	1619	2136	2385	4850		TEMF 050 200 20 101 AS	
220	10	10	342	782	1035	1157	2367		TEMF 050 220 10 101 AS	
		15	561	1273	1680	1876	3815		TEMF 050 220 15 101 AS	
		20	784	1780	2350	2624	5335		TEMF 050 220 20 101 AS	
240	10	10	373	853	1129	1262	2582		TEMF 050 240 10 101 AS	
		15	612	1389	1833	2047	4162		TEMF 050 240 15 101 AS	
		20	855	1942	2563	2862	5820		TEMF 050 240 20 101 AS	
260	10	10	404	925	1223	1368	2798		TEMF 050 260 10 101 AS	
		15	663	1504	1985	2217	4508		TEMF 050 260 15 101 AS	
		20	927	2104	2777	3101	6305		TEMF 050 260 20 101 AS	
280	10	10	436	996	1318	1473	3013		TEMF 050 280 10 101 AS	
		15	714	1620	2138	2388	4855		TEMF 050 280 15 101 AS	
		20	998	2266	2990	3339	6790		TEMF 050 280 20 101 AS	
300	10	10	467	1067	1412	1578	3228		TEMF 050 300 10 101 AS	
		15	765	1736	2291	2558	5202		TEMF 050 300 15 101 AS	
		20	1069	2428	3204	3578	7275		TEMF 050 300 20 101 AS	

Abgabe nach EN442 bei 20°C

TEMPO STANDMODELL

HÖHE 050 (TWIN)

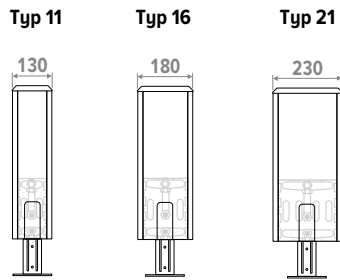

HÖHE H cm	LÄNGE L cm	TYP T	HEIZEN Raumtemperatur 20°C					GEWICHT Kg	WASSERINHALT L	ARTIKELNUMMER
			35/30 Watt	45/40 Watt	50/45 Watt	55/45 Watt	75/65 Watt			
TEMF 050	050	11	93	220	294	330	693		TEMF 050 050 11 101 AS	
		16	123	294	396	445	949		TEMF 050 050 16 101 AS	
		21	162	394	532	599	1291		TEMF 050 050 21 101 AS	
	060	11	112	264	352	396	832		TEMF 050 060 11 101 AS	
		16	147	353	475	534	1139		TEMF 050 060 16 101 AS	
		21	195	473	638	719	1549		TEMF 050 060 21 101 AS	
	070	11	130	307	411	461	970		TEMF 050 070 11 101 AS	
		16	172	412	554	624	1329		TEMF 050 070 16 101 AS	
		21	227	551	744	839	1807		TEMF 050 070 21 101 AS	
	080	11	149	351	470	527	1109		TEMF 050 080 11 101 AS	
		16	196	471	633	712	1518		TEMF 050 080 16 101 AS	
		21	260	630	851	959	2066		TEMF 050 080 21 101 AS	
	090	11	167	395	528	593	1247		TEMF 050 090 11 101 AS	
		16	221	530	712	801	1708		TEMF 050 090 16 101 AS	
		21	292	709	957	1079	2324		TEMF 050 090 21 101 AS	
	100	11	186	439	587	659	1386		TEMF 050 100 11 101 AS	
		16	246	589	792	891	1898		TEMF 050 100 16 101 AS	
		21	325	788	1064	1198	2582		TEMF 050 100 21 101 AS	
	110	11	205	483	646	725	1525		TEMF 050 110 11 101 AS	
		16	270	648	871	980	2088		TEMF 050 110 16 101 AS	
		21	357	867	1170	1318	2840		TEMF 050 110 21 101 AS	
	120	11	223	527	705	791	1663		TEMF 050 120 11 101 AS	
		16	295	707	950	1069	2278		TEMF 050 120 16 101 AS	
		21	389	945	1276	1438	3098		TEMF 050 120 21 101 AS	
	140	11	260	615	822	923	1940		TEMF 050 140 11 101 AS	
		16	344	825	1108	1247	2657		TEMF 050 140 16 101 AS	
		21	454	1103	1489	1678	3615		TEMF 050 140 21 101 AS	
	160	11	298	703	940	1055	2218		TEMF 050 160 11 101 AS	
		16	393	942	1267	1425	3037		TEMF 050 160 16 101 AS	
		21	519	1261	1702	1917	4131		TEMF 050 160 21 101 AS	
	180	11	335	790	1057	1187	2495		TEMF 050 180 11 101 AS	
		16	442	1060	1425	1603	3416		TEMF 050 180 16 101 AS	
		21	584	1418	1915	2157	4648		TEMF 050 180 21 101 AS	
	200	11	372	878	1174	1318	2772		TEMF 050 200 11 101 AS	
		16	491	1178	1583	1781	3796		TEMF 050 200 16 101 AS	
		21	649	1576	2127	2397	5164		TEMF 050 200 21 101 AS	
	220	11	409	966	1292	1450	3049		TEMF 050 220 11 101 AS	
		16	541	1296	1742	1959	4176		TEMF 050 220 16 101 AS	
		21	714	1733	2340	2636	5680		TEMF 050 220 21 101 AS	
	240	11	446	1054	1409	1582	3326		TEMF 050 240 11 101 AS	
		16	590	1413	1900	2137	4555		TEMF 050 240 16 101 AS	
		21	779	1891	2553	2876	6197		TEMF 050 240 21 101 AS	
	260	11	484	1142	1527	1714	3604		TEMF 050 260 11 101 AS	
		16	639	1531	2058	2316	4935		TEMF 050 260 16 101 AS	
		21	844	2048	2765	3116	6713		TEMF 050 260 21 101 AS	
	280	11	521	1230	1644	1846	3881		TEMF 050 280 11 101 AS	
		16	688	1649	2217	2493	5314		TEMF 050 280 16 101 AS	
		21	909	2206	2978	3356	7230		TEMF 050 280 21 101 AS	
	300	11	558	1317	1762	1977	4158		TEMF 050 300 11 101 AS	
		16	737	1767	2375	2672	5694		TEMF 050 300 16 101 AS	
		21	974	2364	3191	3595	7746		TEMF 050 300 21 101 AS	

Abgabe nach EN442 bei 20°C

TEMPO STANDMODELL

EINZELTEILE

VERKLEIDUNG

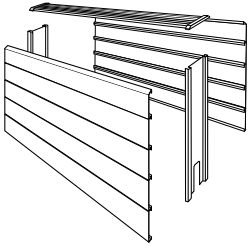

STANDARD-LIEFERUNG:

- Rost
- 2 Paneele
- offene und geschlossene Seite
- Farbe 101

ARTIKELNUMMER

CTEF 020 040 10 101
 Typ
 Länge
 Höhe

HEIZUNGSSET

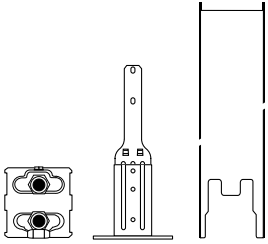

STANDARD-LIEFERUNG:

- Wärmetauscher
- konsolen
- abgewinkelter Entlüfter (für die Typen 10, 15 und 20) oder verlängerter Entlüfter (für die Typen 11, 16 und 21)
- Standardfüße
- Entlüfstopsfen 1/2"

ARTIKELNUMMER

HTEF 020 040 10
 Typ
 Länge
 Höhe

ROST

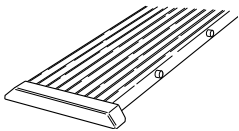

ARTIKELNUMMER

5603 000 040 10 101
 Typ
 Länge

SEPARATE FRONTPLATTE (Höhe 10 cm, identisch für alle Verkleidungen)



ARTIKELNUMMER

5504 000 050 00 101
 Länge

SEPARATE OBERPLATTE (Höhe 10 cm, identisch für alle Verkleidungen)



ARTIKELNUMMER

5505 000 050 00 101
 Länge

SEITEN (paarweise open/dicht)

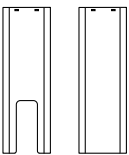

ARTIKELNUMMER

5754 020 000 10 XXX
 Farbe
 Typ
 Höhe

ECKSTÜCK AUS KUNSTSTOFF (PAARWEISE LINKS / RECHTS)

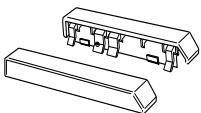

ARTIKELNUMMER

5604 000 000 10
 Typ

STANDARDMÄSSIG EINSTELLBARER FUSS

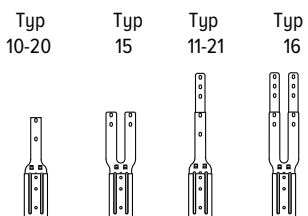

Höhenverstellbar von 135 mm bis 185 mm

Anzahl der Füße für den Wärmetauscher (1 pro Konsole)

- von 050 bis 110 cm Länge: 2 Stück
- von 120 bis 220 cm Länge: 3 Stück
- von 240 bis 280 cm Länge: 4 Stück

Die Füße (standardmäßig in neutralem Grau) sind auch in der gleichen Farbe wie die Polsterung erhältlich. Wiederholen Sie dazu den Farbcode der Polsterung nach dem Code des Fußes.
 z.B.: 5201 000 000 10 xxx

ARTIKELNUMMER

5201 000 000 10
 Typ

TEMPO STANDMODELL

EINZELTEILE

VERLÄNGERTER VERSTELLBARER FUSS FÜR DIE PLATZIERUNG IN FÜLLBETON

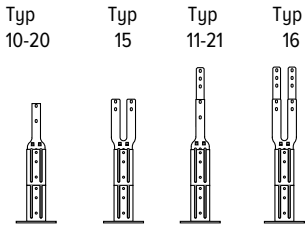

Höhenverstellbar von 255 mm bis 290 mm

KONSOLEN (pro Stück)

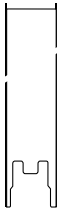

Anzahl der FüÙe für den Wärmetauscher (1 pro Konsole)

- von 050 bis 110 cm Länge: 2 Stück
- von 120 bis 220 cm Länge: 3 Stück
- von 240 bis 280 cm Länge: 4 Stück

FüÙe in Farbe der Polsterung.

Die FüÙe (standardmäßig in neutralem Grau) sind auch in der gleichen Farbe wie die Polsterung erhältlich. Wiederholen Sie dazu den Farbcode der Polsterung nach dem Code des Fußes.

z.B.: 5202 000 000 10 xxx

ARTIKELNUMMER

5202 000 000 10
└─ Typ

ARTIKELNUMMER

5151 020 000 10
└─ Wärmetauscher-Typ
└─ Höhe

WÄRMETAUSCHER



Anzahl der Halterungen für den Wärmetauscher

- von 050 bis 110 cm Länge: 2 Stück
- von 120 bis 220 cm Länge: 3 Stück
- von 240 bis 280 cm Länge: 4 Stück

STANDARD-LIEFERUNG:

- Wärmetauscher
- inkl. rechteckiger Entlüfter und Ablassschraube

ARTIKELNUMMER

5003 000 050 06
└─ Wärmetauscher-Typ
└─ Länge

Übersicht der Wärmetauschertypen

	Tempo Typ 10	Tempo Typ 11	Tempo Typ 15	Tempo Typ 16	Tempo Typ 20	Tempo Typ 21
HÖHE 020	 Typ 10		 Typ 15		 Typ 20	
HÖHE 035	 Typ 10	 Typ 11	 Typ 15	 Typ 16	 Typ 20	 Typ 21

VERLÄNGERTER ENTLÜFTER 1/8"



Artikelnummer	H20			H35						
	Typ	10	15	20	10	11	15	16	20	21
50900114 078	✓	✓	✓	-	✓	-	✓	-	✓	-
50900114 178	-	-	-	✓	-	✓	-	✓	-	-
50900114 278	-	-	-	-	-	-	-	-	-	-
50900114 378	-	-	-	-	-	-	-	-	-	-
50900114 528	-	-	-	-	-	-	-	-	-	-
50900114 728	-	-	-	-	-	-	-	-	-	-

Die angegebenen Leistungen bei ΔT 50 und ΔT 60 sind exakte Werte. ΔT 50 ist nach EN442 gemessen, ΔT 60 nach EN442 berechnet. Für alle anderen ΔT gibt diese Tabelle einen durchschnittlichen Korrekturfaktor, gültig für alle Abmessungen.

Auf www.jaga.com/selection-tools/ finden Sie Berechnungstools mit den exakten Leistungen. Die Online-Berechnungstools werden immer mit den neuesten Daten aktualisiert. Geringfügige Differenzen zwischen bereits gedruckten Tabellen und den verschiedenen Online-Berechnungstools sind daher völlig normal und liegen innerhalb der vom Standard vorgegebenen Toleranzgrenzen.

GEMITTELTE KORREKTURFAKTOREN STATISCHE PRODUKTE NACH EN442 - 75/65/20°C

Raumtemperatur: 20°C Durchschnittlicher N-Wert: 1.36

TR	65	60	55	50	45	40	35	30	25
TA									
75	1.00	0.93	0.85	0.77	0.69	0.61	0.52	0.42	0.31
70	0.94	0.87	0.79	0.72	0.64	0.56	0.48	0.39	0.28
65		0.80	0.74	0.67	0.60	0.52	0.44	0.35	0.25
60			0.68	0.61	0.55	0.48	0.40	0.32	0.23
55				0.56	0.50	0.43	0.36	0.29	0.20
50					0.44	0.38	0.32	0.25	0.18
45						0.34	0.28	0.22	0.15
40							0.24	0.19	0.13
35								0.15	0.10
30									0.07

Durchschnittliche Korrekturfaktoren für Strada (ohne DBH). Genaue Korrekturfaktoren für Strada oder Strada Hybrid: siehe Auswahltools.

Raumtemperatur: 24°C Durchschnittlicher N-Wert: 1.36

TR	65	60	55	50	45	40	35	30	25
TA									
75	0.89	0.82	0.75	0.67	0.59	0.51	0.41	0.31	0.16
70	0.83	0.76	0.69	0.62	0.54	0.47	0.38	0.28	0.14
65		0.70	0.64	0.57	0.50	0.43	0.35	0.25	0.12
60			0.58	0.52	0.45	0.38	0.31	0.23	0.11
55				0.47	0.41	0.34	0.28	0.20	0.09
50					0.36	0.30	0.24	0.17	0.08
45						0.26	0.20	0.14	0.06
40							0.17	0.12	0.05
35								0.09	0.03
30									0.02

RICHTLINIE ZUR BEGRENZUNG VON STRÖMUNGSGERÄUSCHEN

ROHR	Außen Ø	Wandstärke	Max. Wassergeschwindigkeit (EN10255)	Wasserinhalt pro Meter	max. Wasserdurchfluss	Maximale Leistung bei ΔT (°C) (T Vorlauf - T Rücklauf)						
						ΔT 30	ΔT 20	ΔT 10	ΔT 5	ΔT 4	ΔT 3	ΔT 2
	mm	mm	m/s	l	kg/St.	Watt	Watt	Watt	Watt	Watt	Watt	Watt
VERZINKTES ROHR DIN 2440												
3/8 DN10 OD	17.2	2.35	0.40	0.12	173	6028	4019	2009	1005	804	603	402
1/2 DN15 OD	21.3	2.65	0.40	0.20	288	10046	6698	3349	1674	1340	1005	670
3/4 DN20 OD	26.9	2.65	0.42	0.37	559	19515	13010	6505	3253	2602	1952	1301
1 DN25 OD	33.7	3.25	0.49	0.58	1023	35690	23793	11897	5948	4759	3569	2379
1 1/4 DN32 OD	42.4	3.25	0.60	1.01	2182	76101	50734	25367	12684	10147	7610	5073
1 1/2 DN40 OD	48.3	3.25	0.66	1.37	3255	113549	75700	37850	18925	15140	11355	7570
2 DN50 OD	60.3	3.65	0.80	2.21	6365	222025	148017	74008	37004	29603	22203	14802
PRÄZISIONSMETALLROHR												
10/1	10	1.00	0.40	0.05	72	2512	1674	837	419	335	251	167
12/1	12	1.00	0.40	0.08	115	4019	2679	1340	670	536	402	268
14/1	14	1.00	0.40	0.11	158	5526	3684	1842	921	737	553	368
15/1	15	1.00	0.40	0.13	187	6530	4353	2177	1088	871	653	435
16/1	16	1.00	0.40	0.15	216	7535	5023	2512	1256	1005	753	502
18/1	18	1.00	0.40	0.20	288	10046	6698	3349	1674	1340	1005	670
22/1	22	1.00	0.40	0.31	446	15572	10381	5191	2595	2076	1557	1038
28/1	28	1.00	0.47	0.53	904	31522	21014	10507	5254	4203	3152	2101
VPE/ALU												
12/2	12	2.00	0.40	0.05	72	2512	1674	837	419	335	251	167
14/2	14	2.00	0.40	0.08	115	4019	2679	1340	670	536	402	268
16/1.5	16	1.50	0.40	0.13	187	6530	4353	2177	1088	871	653	435
16/2	16	2.00	0.40	0.11	158	5526	3684	1842	921	737	553	368
17/2	17	2.00	0.40	0.13	187	6530	4353	2177	1088	871	653	435
18/2	18	2.00	0.40	0.15	216	7535	5023	2512	1256	1005	753	502
20/2	20	2.00	0.40	0.20	288	10046	6698	3349	1674	1340	1005	670
26/3	26	3.00	0.40	0.31	446	15572	10381	5191	2595	2076	1557	1038
32/3	32	3.00	0.47	0.53	904	31522	21014	10507	5254	4203	3152	2101
40/3.5	40	3.50	0.56	0.86	1726	60220	40147	20073	10037	8029	6022	4015
50/4.25	50	4.25	0.66	1.35	3206	111824	74549	37275	18637	14910	11182	7455
63/5	63	5.00	0.80	2.21	6346	221359	147573	73786	36893	29515	22136	14757

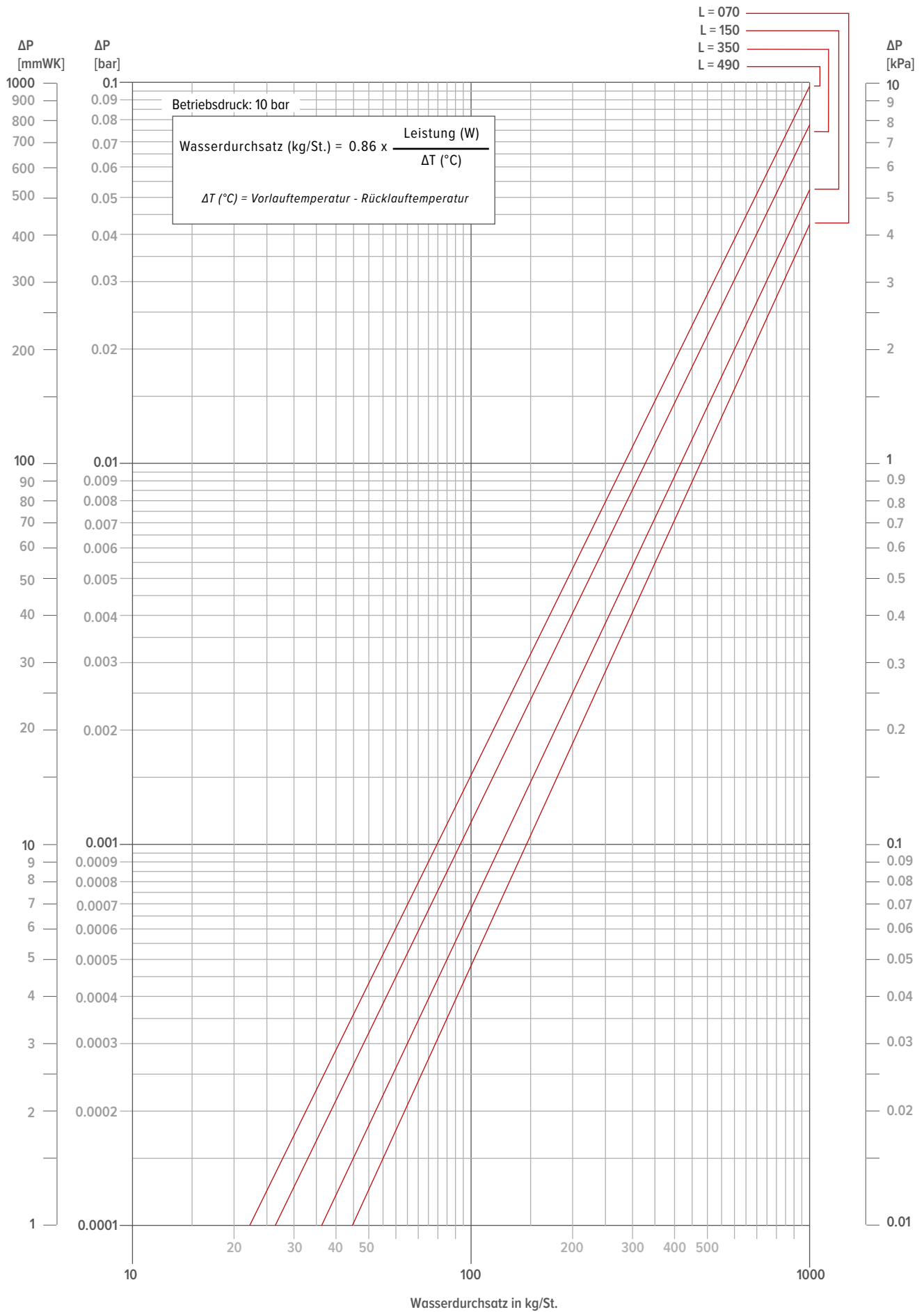

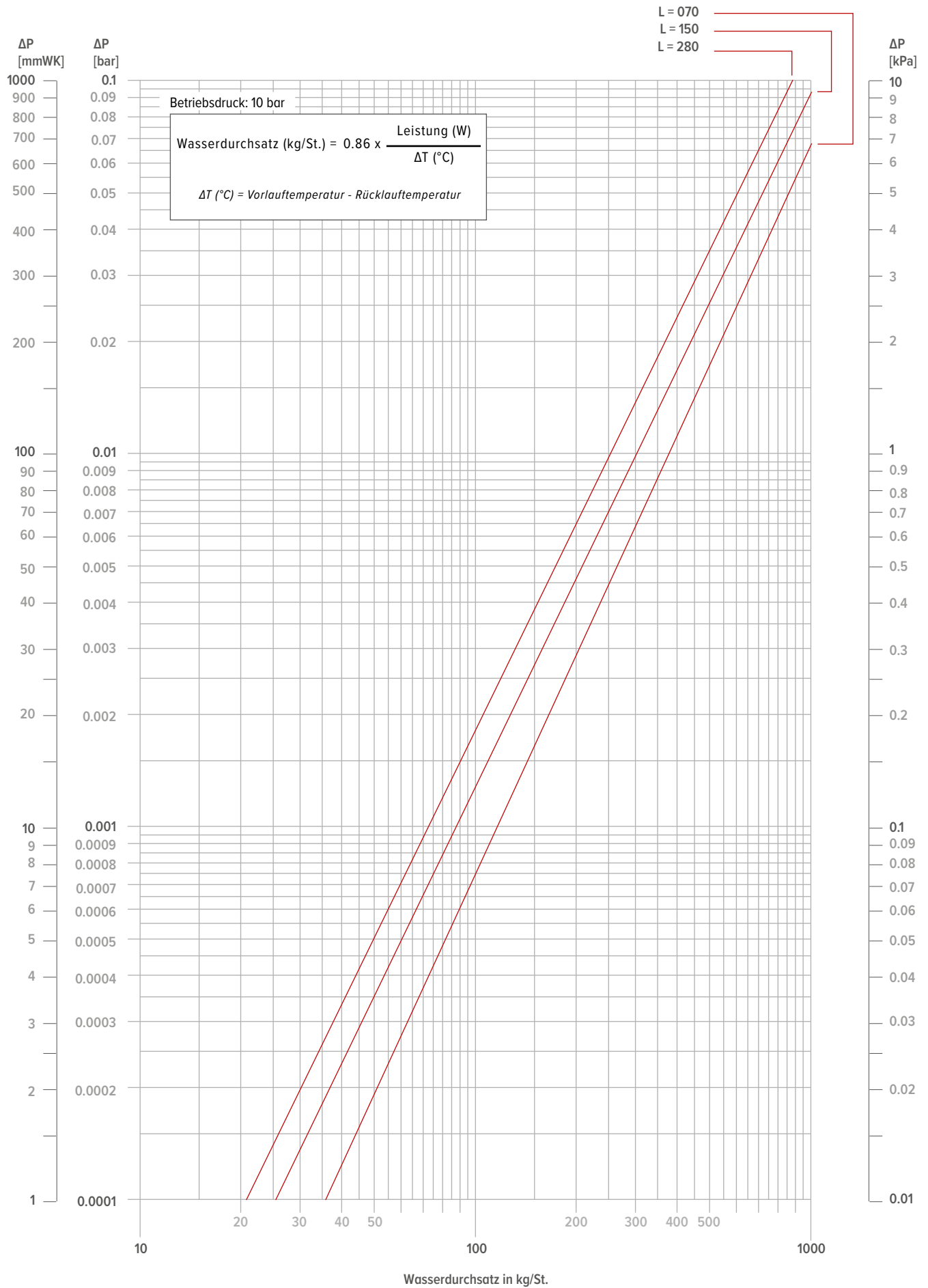

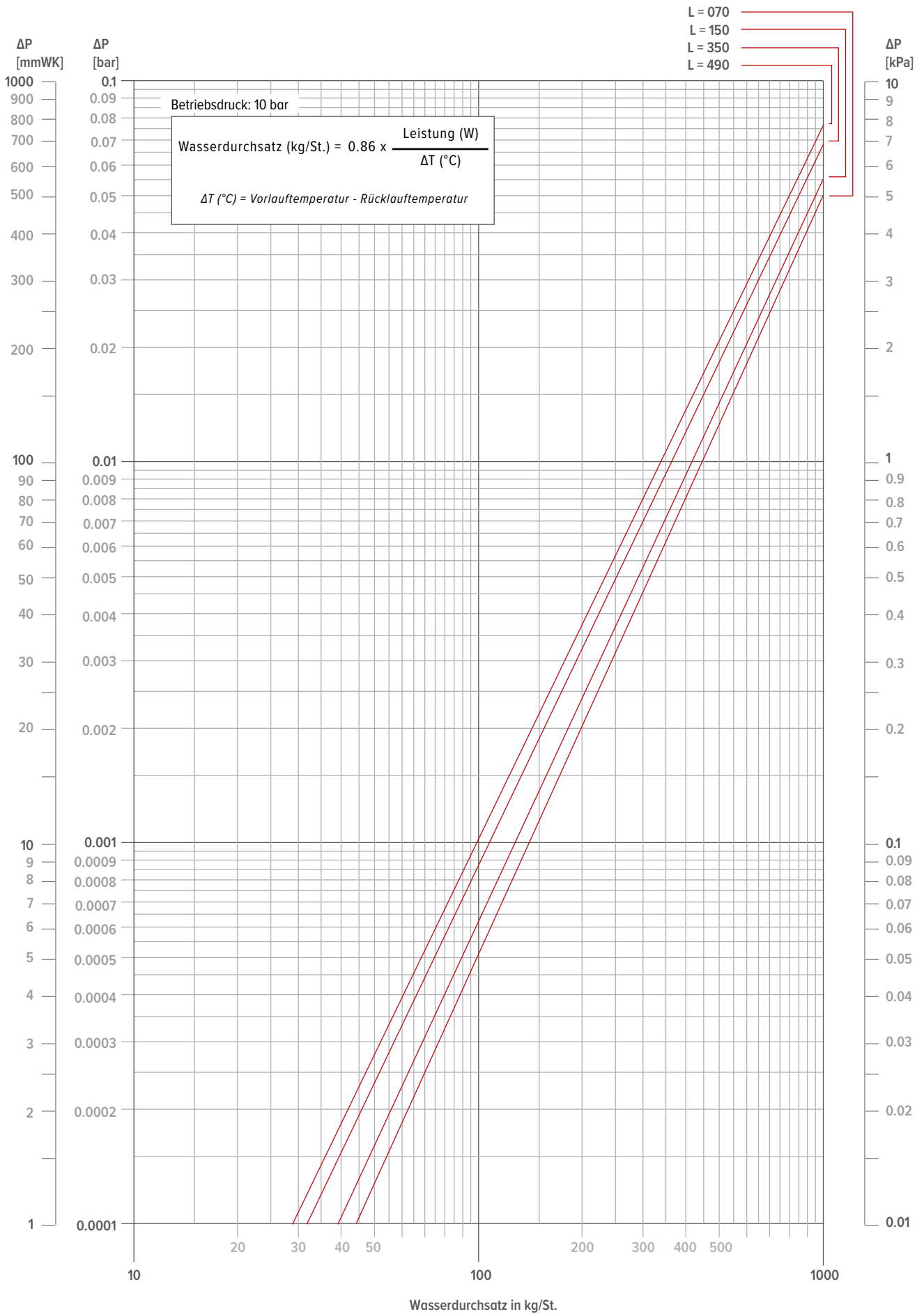

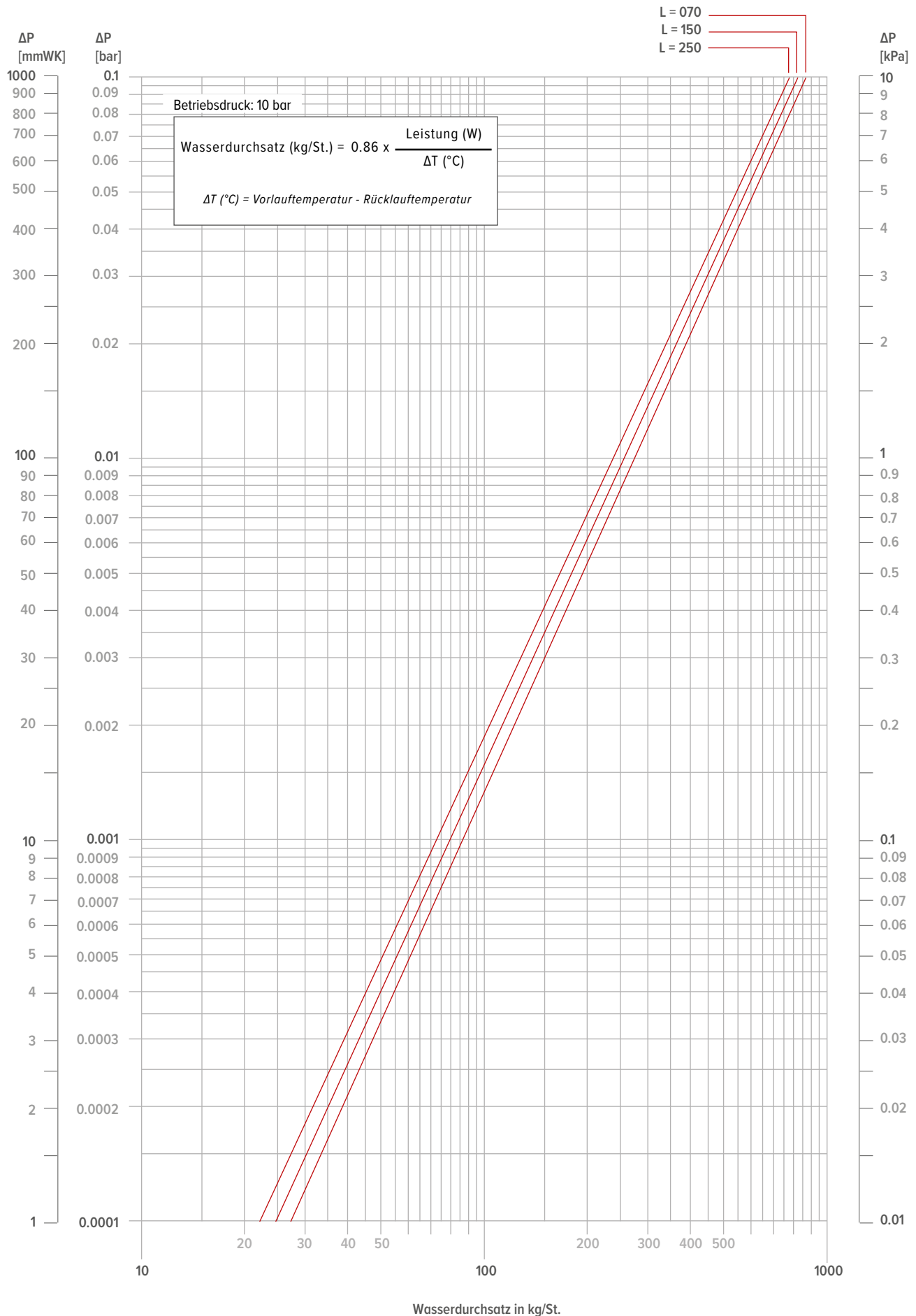

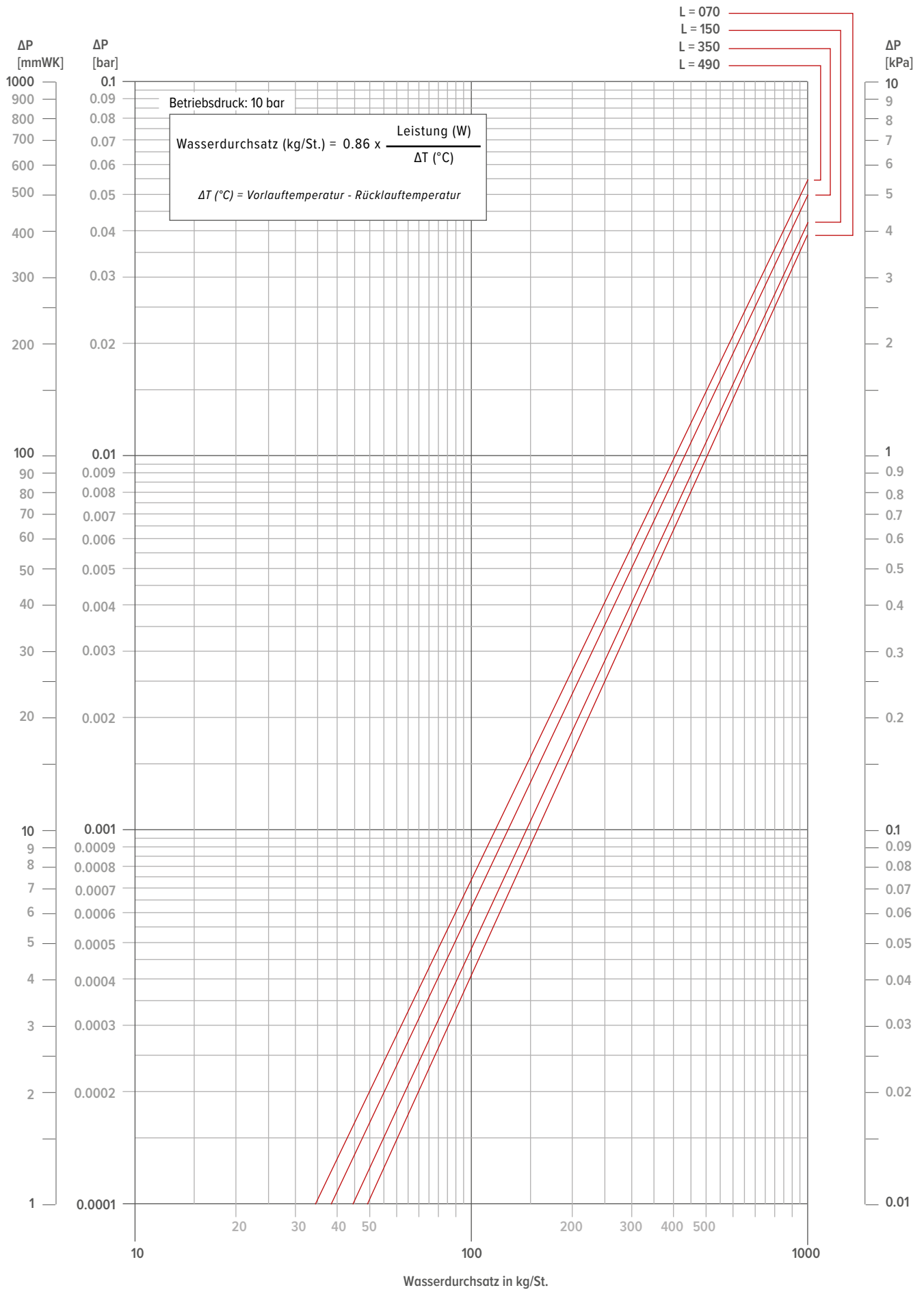

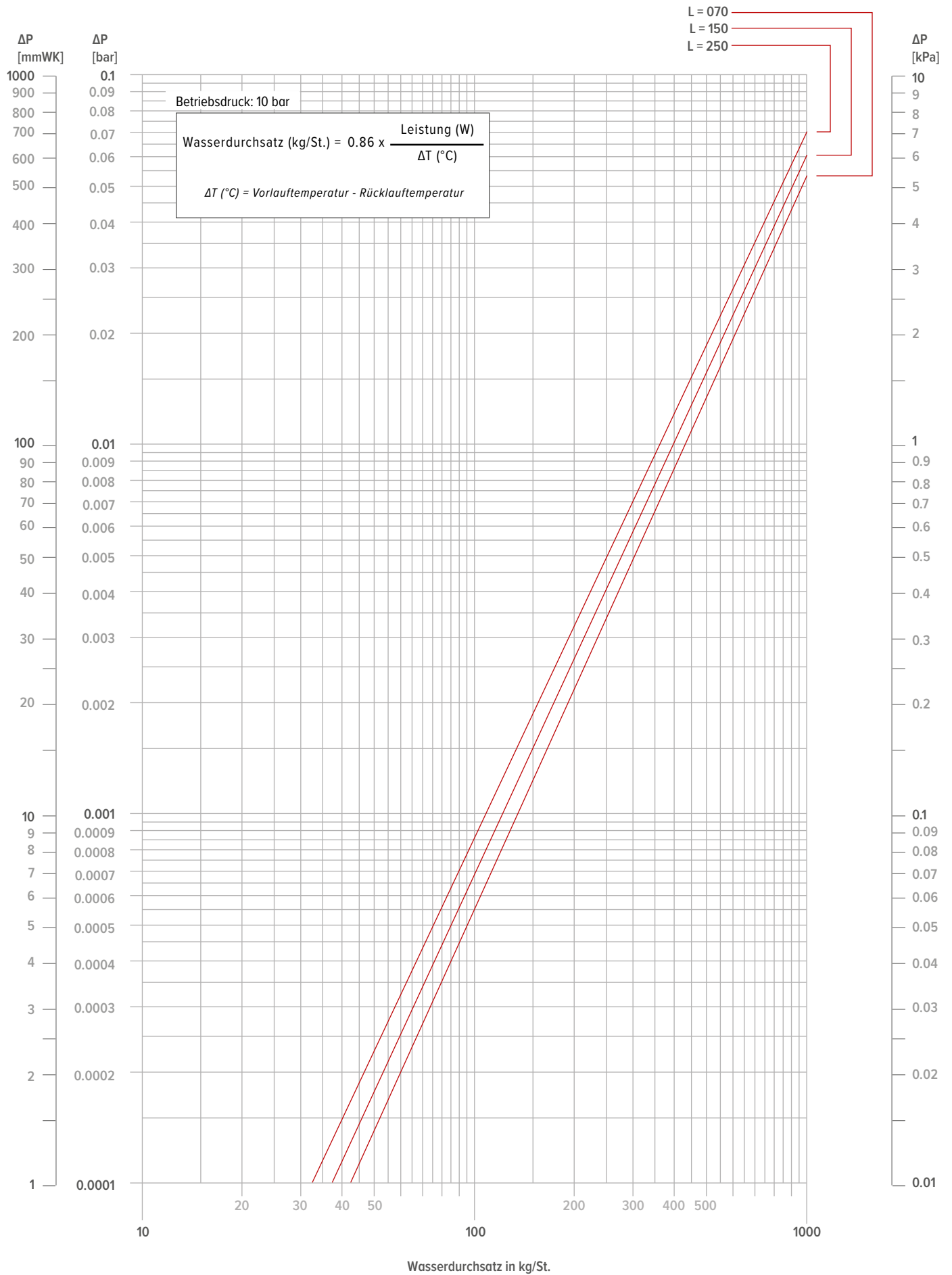



JAGA DEUTSCHLAND GMBH

Adenauerstrasse 20, Geb. A2 - OG 1
D-52146 Würselen

T +49 (0)240 589 241 40

info@jaga.de
www.jaga.com/de

JAGA SCHWEIZ UND NORDITALIEN

T +49 (0)152 225 996 70

hmelchior@jaga.de
www.jaga.com/ch

JAGA N.V AUSTRIA SÜDTIROL/SWISS

Altenhof 2
8385 Neuhaus am Klausenbach

T +43 65 0800 80 99

jaga-austria@aon.at
www.jaga.com/at

BELGIEN JAGA NV

Verbindingslaan 16
3590 Diepenbeek

+32 (0) 11 29 41 11

info@jaga.be
jaga.com