

opmerking - remarque - Anmerkung - remark

Daar de Heatwave een artisaanaal product is kunnen er kleine kleur- of maatafwijkingen voorkomen. Deze kleurafwijking stabiliseert zich na het uitharden van de gebruikte materialen.

Dans la mesure où le Heatwave est un produit artisanal, des petites différences de couleurs ou de dimensions sont possibles. Cette différence de couleur se stabilise après le durcissement des matériaux utilisés.

Da der Heatwave ein handgemachtes Produkt ist, können kleine Farb- oder Maßabweichungen vorkommen. Diese Farbabweichungen geben sich mit der Zeit, sie passen sich durch die Nutzung an.

The Heatwave is a hand-crafted product. Hence, minor colour or dimensional variations can sometimes be evident. After initial curing, minor colour variations will tend to even out over the surface of the material.

* Het is mogelijk de Heatwave over een bereik van 360° te monteren.
- De positie van de Heatwave in deze handleiding geniet de voorkeur van de ontwerper.

* Il est possible de monter le Heatwave sur une portée de 360°.
- La position du Heatwave décrite dans ce manuel a la préférence du concepteur.

* Der Heatwave lässt sich im 360° Bereich montieren.
- Die Position des Heatwave wird im Hinweis als die bevorzugte Position des Entwicklers gezeigt.

* It is possible to fix the Heatwave over a range of 360°.
- The position of the Heatwave shown in the manual is the position preferred by the designer.

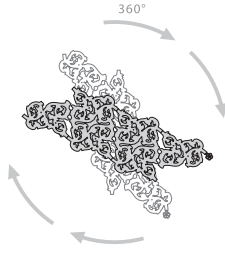

Onderdelen - Parts - Teile

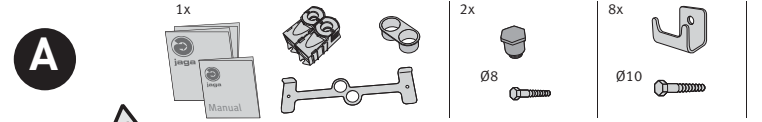

Om veiligheidsredenen zijn geen muurpluggen meegeleverd. Contacteer uw specialzaak voor het juiste type.
Pour des raisons de sécurité, les chevilles ne sont pas fournies. Contactez votre magasin spécialisé pour le bon type de cheville.
Aus Sicherheitsgründen sind kein Dübel mitgeliefert. Kontaktieren Sie Ihren Baustoffhandel für die richtigen Dübel.
For safety reasons wall plugs aren't delivered. Contact your specialist store for the right type.

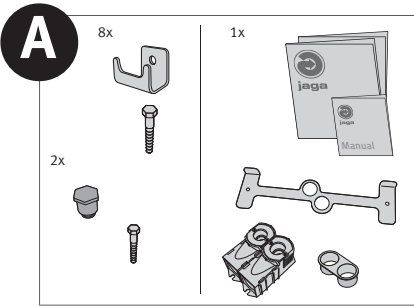
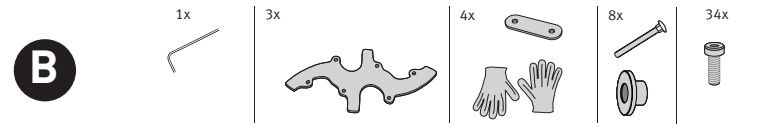

Neem het ophangjabloon, de onderdelen voor de muurbevestiging en de aansluiting uit de verpakking.

Prenez l'outil de montage, les pièces pour la fixation murale et le raccordement dans l'emballage.

Nehmen Sie die Montageschablone, die Einzelteile für die Wandbefestigung und den Ventilanschluss aus der Verpackung.

Remove the stencil, the fixings and the valve connections from the packaging.

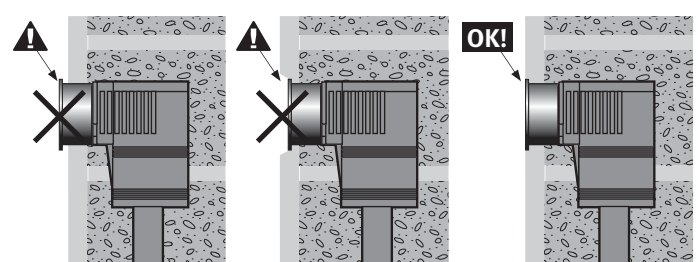
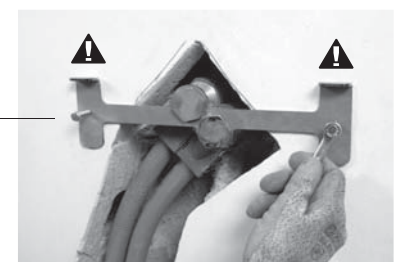
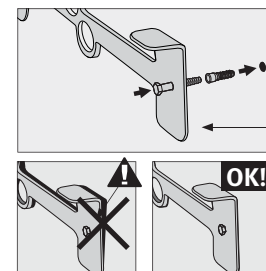
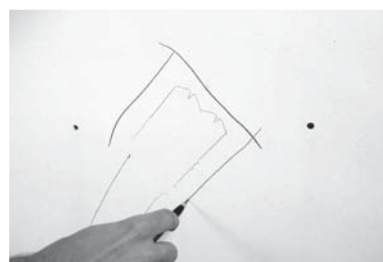
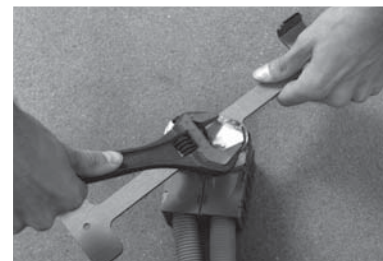
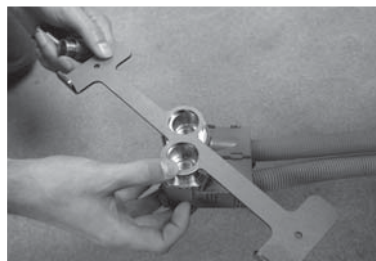
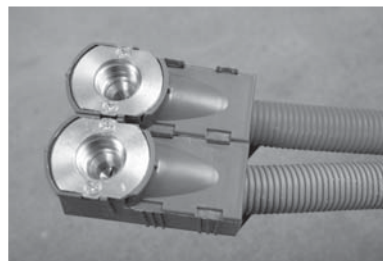
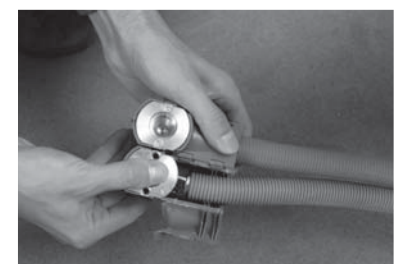
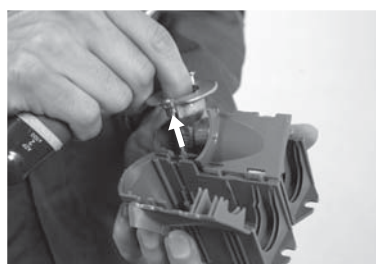
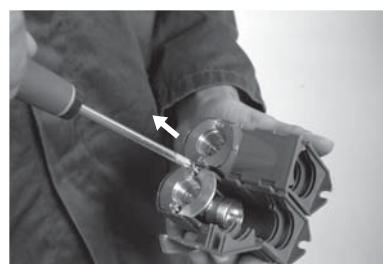
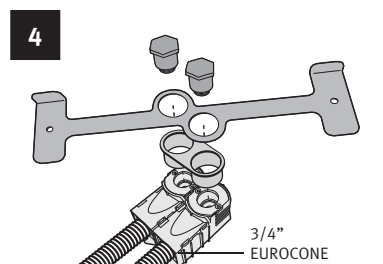
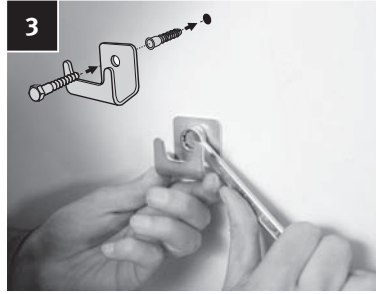
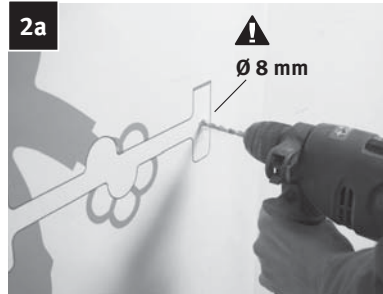
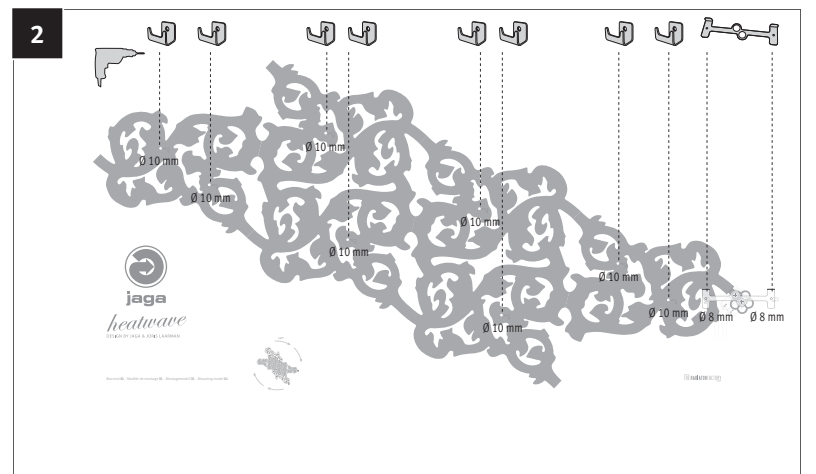
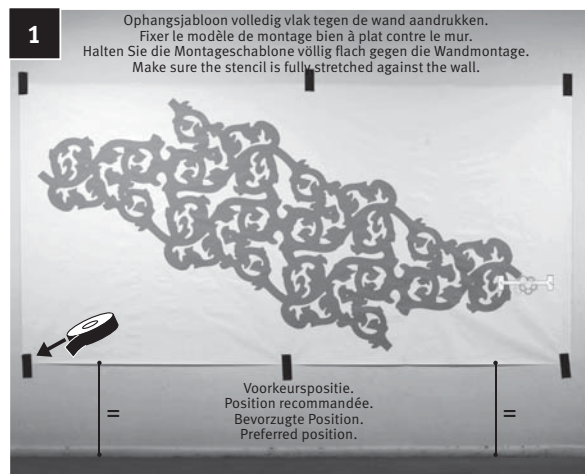

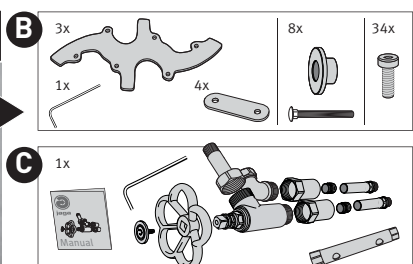
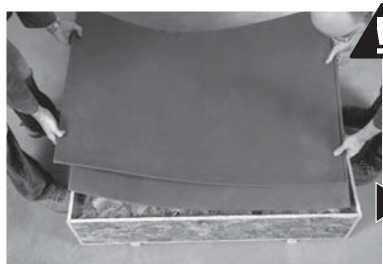
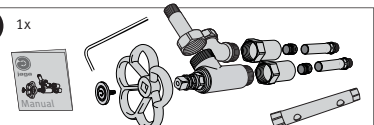
B**1****C**

Gebruik het schuimrubber als bescherming op de vloer tijdens de montage van de Heatwave.
 Utilisez la mousse de caoutchouc comme protection sur le sol pendant le montage du Heatwave.
 Benutzen Sie den Schaumgummi als Fußbodenschutz, wenn Sie den Heatwave montieren.
 A foam rubber mat is supplied for protection of the Heatwave during assembly. Please place this on the floor and assemble the radiator on it before mounting.

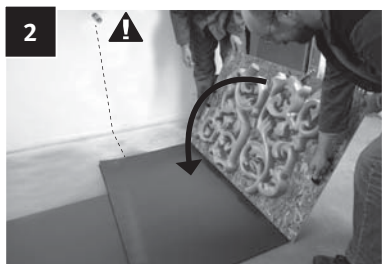
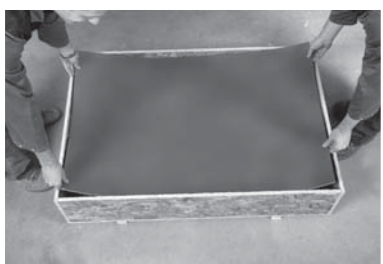
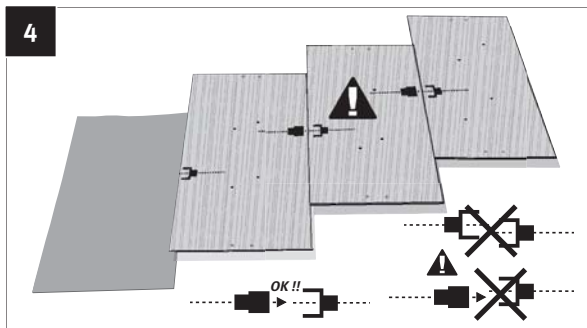
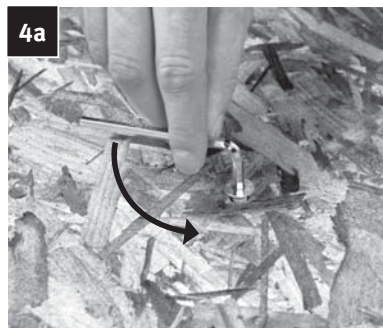
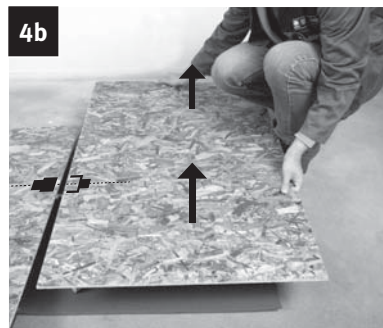
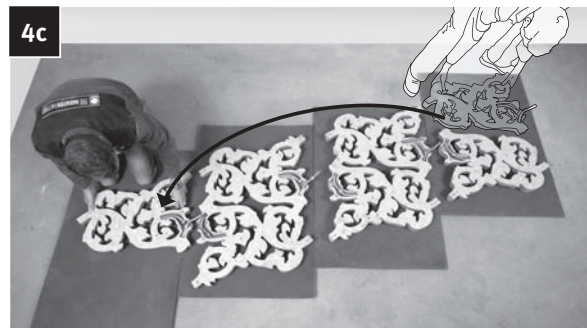
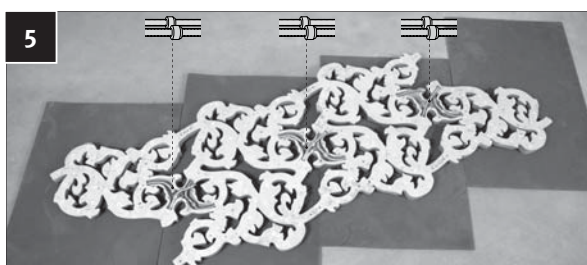
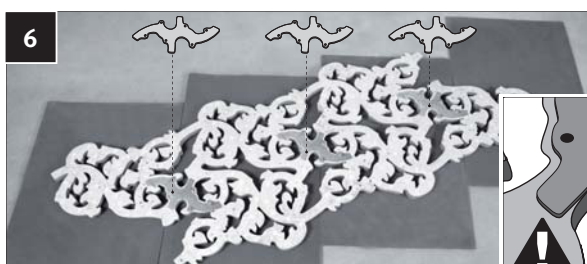
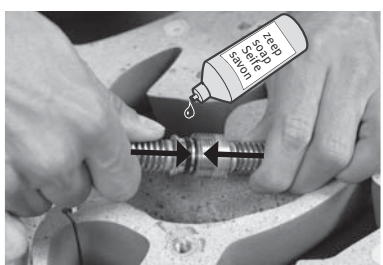
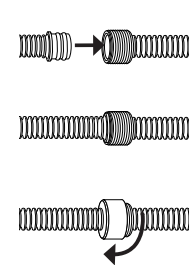
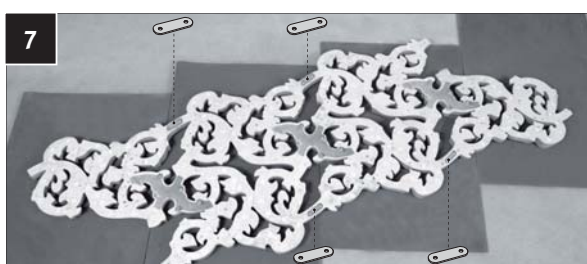
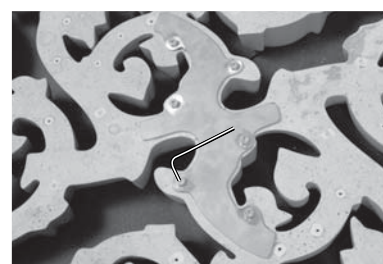
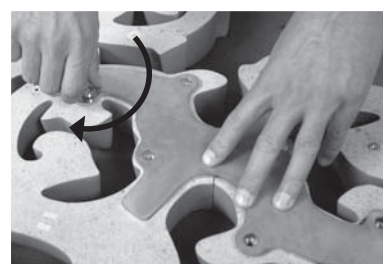
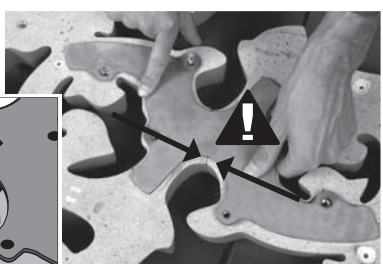
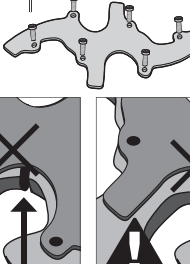
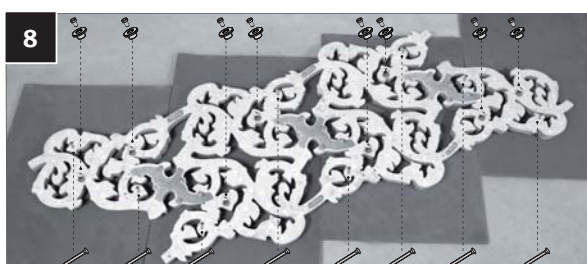
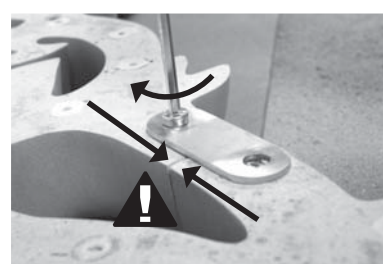
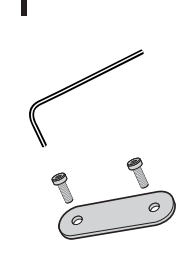
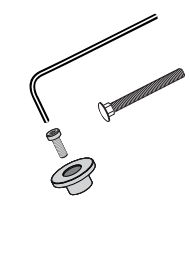
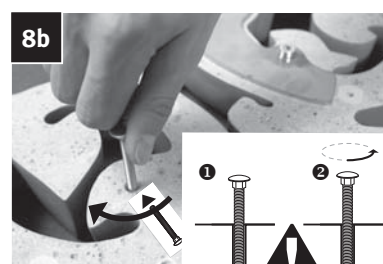
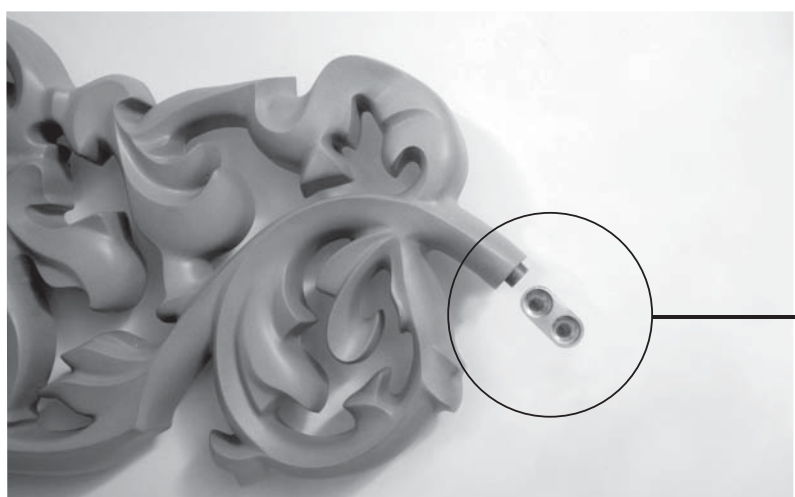
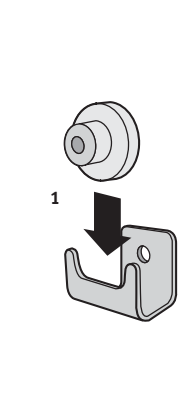
**2****3a****3b****4****4a****4b****4c****5****6****7****8****8a****9**

aansluiting - raccordement
 Anschluß - connection

C