



**jaga**  
CLIMATE DESIGNERS



## STRADA HYBRID





# STRADA HYBRID

<b>INHOUDSOPGAVE</b>	<b>3</b>
<b>TECHNISCHE INFORMATIE</b>	<b>5</b>
Afmetingen	5
Optie handdoekhouder	5
<b>STURINGEN</b>	<b>6</b>
Welke Jaga sturing kiezen?	7
Waterzijdige aansluiting	8
Aansluiting links of rechts.	8
Bediening beneden (Standaard)	8
Bediening bovenaan	8
Met bediening op afstand	8
Meest gebruikte aansluitsets	9
Technische tabel	10
Hoogte 035	10
Hoogte 050	12
Hoogte 065	14
Hoogte 095	16
Onderdelen	17
Correctiefactoren	20
Richtlijn voor het beperken van stromingsgeluiden	20
Drukverliezen	21
Type 11	21
Type 16	22
Type 21	23



# STRADA HYBRID



AFMETINGEN (in mm)

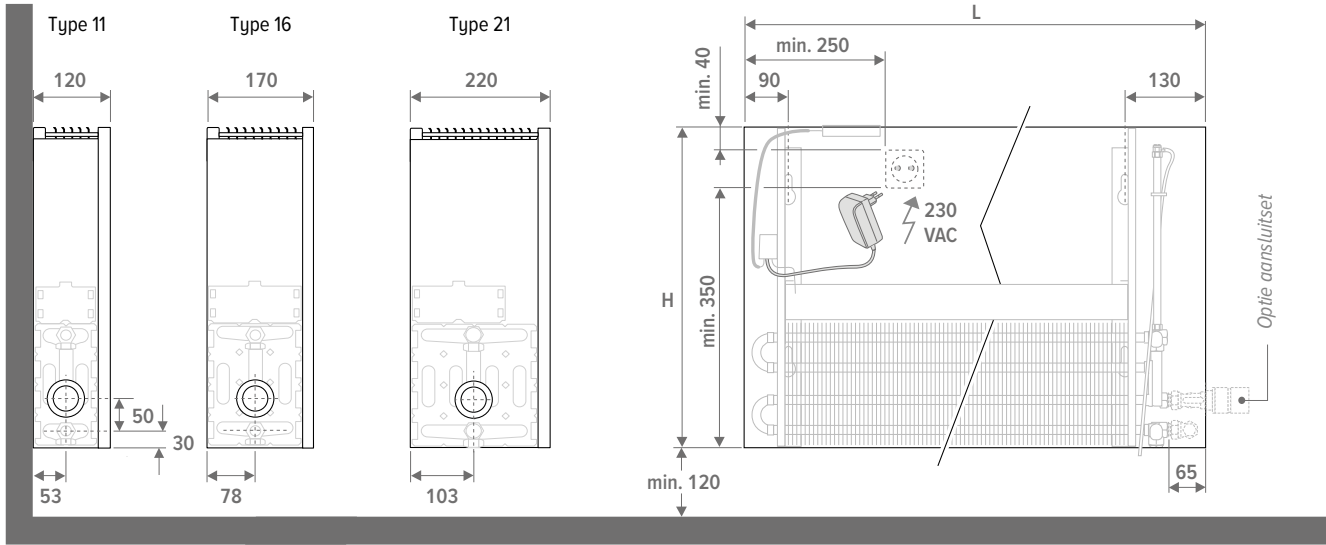

## STANDAARD LEVERING

- Low-H<sub>2</sub>O warmtewisselaar met wandconsoles, bevestigingsset, verlengde ontlufter 1/8" en aftapstop 1/2"
- deels voorgemonteerde bekleding voor aansluiting links of rechts beneden
- afdekplaatje in RVS-look voor niet gebruikte aansluitzijde
- eenvoudig te plaatsen ventilator-unit met bediening, sturing en voeding 24 VDC

**!** De convector is niet voorzien van een condensbewaking. Deze dient in de installatie geïntegreerd te worden (enkel voor koeling).

## KLEUREN

Milieuvriendelijk gelakt met krasvaste poedercoating met hoge UV-bestendigheid

### Standaard kleuren

- verkeerswit RAL 9016 (133), soft touch licht gestructureerde satijn lak
- zandstraalgrijs (001), fine texture metallic lak
- off-black (145), soft touch licht gestructureerde satijn lak

### Andere kleuren

zie Jaga kleurenkaart.

Meerprijs afhankelijk van de lengte van het toestel:

- Lengte < 100 cm
- Lengte van 100 cm tot 200 cm
- Lengte > 200 cm

## HANDDOEKHOUDER

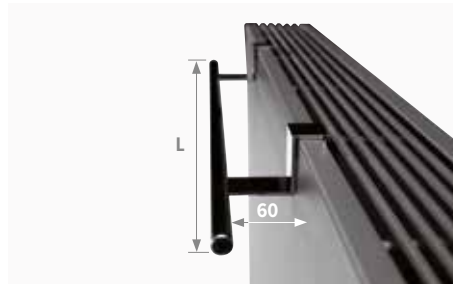

CODE	L	
5501 001	560	in verchroomd aluminium
5501 002	660	in verchroomd aluminium

## BESTELCODE

STRW 035 050 11 XXX DDD

Sturing: D01: Jaga TPT  
D03: Jaga BMS  
D09: Jaga ACO

Kleur

Type





Lengte

Hoogte

BEDIENINGSPANEEL



JDPC (Jaga Dynamic Product Controller)

TYPE	FUNCTIE	BEDIENINGSPANEEL	EXTERNE 0-10 V AANSTURING	WATERTEMP. SENSOR	LUCHTTEMP. SENSOR
Jaga ACO (D09)	  	✓	-	✓	✓
Jaga BMS 0-10V regeling (D03)	 	-	✓	✓	-
Jaga TPT (D01)	 	✓	-	✓	✓

**JAGA ACO (D09)**

- De ventilatorsnelheid wordt manueel in 3 standen gekozen via het bedieningspaneel.
- Wanneer de watertemperatuur lager is als 24°C en de lucht warmer is dan het water in de warmtewisselaar starten de ventilatoren. Het toestel koelt dan de ruimte.
- Wanneer de watertemperatuur hoger is als 28°C en de lucht kouder is dan het water starten de ventilatoren. Het toestel verwarmt dan de ruimte.
- Het toestel **schakelt automatisch** van verwarmen naar koelen en naar stand-by mode.

**JAGA BMS 0-10V REGELING (D03)**

- De ventilatorsnelheid wordt enkel **aangestuurd door een 0-10V (DC) signaal** dat van een extern regelsysteem aangelegd wordt aan de elektronica van het toestel. Het 0-10V signaal kan aangelegd worden van een Jaga thermostaat of een ander domotica- of gebouwbeheersysteem.
- Wanneer de stuurspanning 1V of hoger is en de watertemperatuur hoger is dan 28°C of lager is dan 24°C starten de ventilatoren. Het toerental loopt evenredig op met de aangelegde stuurspanning. Bij 10V stuurspanning draaien de ventilatoren op maximaal toerental.
- Wanneer een Hybrid toestel met Jaga BMS sturing uitgerust wordt met een **thermo-elektrische ventielmotor** die op de interne elektronica aangesloten is, dan opent het ventiel wanneer de stuurspanning hoger is dan 1V.

**JAGA TPT (D01)**

- De ventilatorsnelheid wordt automatisch gestuurd in functie van de ingestelde comforttemperatuur via de tiptoetsbediening. Hierdoor wordt het toestel zeer stil wanneer de comforttemperatuur bereikt is.
- Wanneer een Hybrid toestel met Jaga TPT sturing uitgerust wordt met een thermo-elektrische ventielmotor die op de interne elektronica aangesloten is, dan neemt het toestel de functie van kamerthermostaat over. Het toestel zal dan zelf op basis van kamertemperatuurmeting het waterdebiet door het toestel in- of uitschakelen. Wanneer de watertemperatuur in de warmtewisselaar lager is dan 24°C starten de ventilatoren. Het toestel koelt dan de ruimte.
- Wanneer men de **kamertemperatuur wenst in te stellen** via een ander systeem dat het waterdebiet door het toestel in- of uitschakelt, dan dient men geen thermo-elektrische ventielmotor op de interne controller aan te sluiten. De TPT sturing zal dan enkel het ventilatortoerental sturen op basis van de ingestelde comforttemperatuur. Intuïtief gebruikt men de tiptoetsbediening dan om meer of minder ventilatorondersteuning te krijgen bij het bereiken van de comforttemperatuur.
- Wanneer de watertemperatuur in de warmtewisselaar lager is dan 24°C starten de ventilatoren. Het toestel koelt dan de ruimte.
- Wanneer de watertemperatuur hoger is als 28°C starten de ventilatoren. Het toestel verwarmt dan de ruimte.





Wens je kamertemperatuurregeling op het toestel?

**Ja, kamertemperatuurregeling in het toestel**  
Ventilatoren starten automatisch wanneer de interne regeling warm/koud water door de radiator stuurt

**Nee, kamertemperatuurregeling buiten het toestel**  
Ventilatoren starten automatisch wanneer de externe regeling warm/koud water door de radiator stuurt

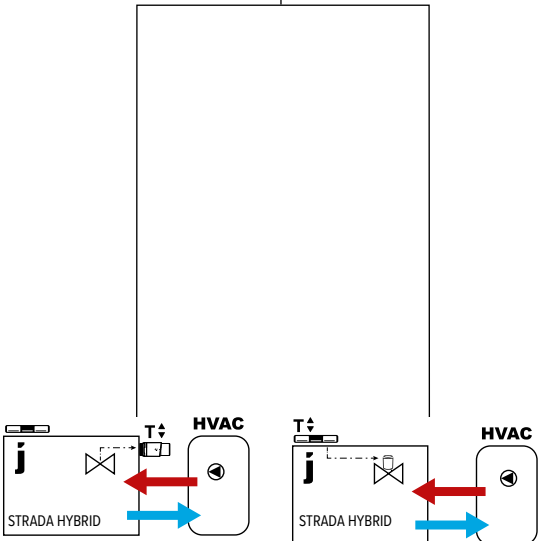
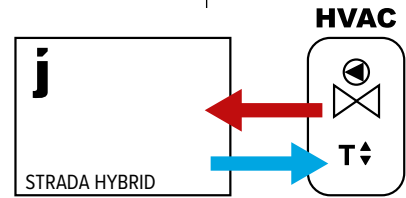
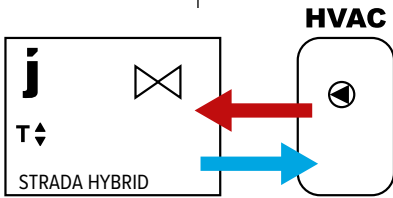

Verwarming: temperatuurregeling via thermostatisch radiatorventiel (TRV)  
Koeling: thermostaatkop / adapter staat op koelstand, geen temperatuurregeling

Temperatuurregeling via bedieningspaneel op toestel (thermo-elektrisch ventiel in de radiator aangesloten op elektronica van het toestel)

Ventilatorsnelheid wordt bepaald door 3-standenbediening

Ventilatorsnelheid past zich aan, aan de kamertemperatuur en de ingestelde gewenste kamertemperatuur (via tiptoetsbediening)

**JAGA ACO**

**JAGA TPT**

Codering: D09

D01

- Zonder 0-10V signaal:
- kamerthermostaat (Geen-Jaga)
  - zoneregeling met kamertemp. regeling
  - ketel- of warmtepompsturing met kamertemp. regeling
  - domotica met kamertemp. regeling
  - andere externe kamertemp. regelingen

- 0-10V signaal voor ventilatorsturing beschikbaar van
- Jaga kamerthermostaat met 0-10V signaal naar toestel
  - domotica beschikbaar met 0-10V signaal naar toestel

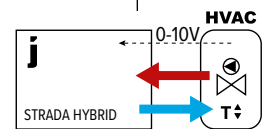
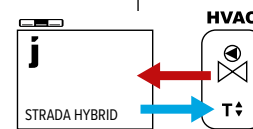
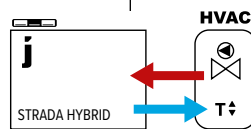

Kies 1 van de 3 ventilatorsnelheden (snelheid past zich niet aan, aan de kamertemperatuur)

Ventilatorsnelheid past zich aan, aan de kamertemperatuur. Stel het temperatuurbereik in via het bedieningspaneel.

Ventilatorsnelheid wordt gestuurd door 0-10V aansluiting op de elektronica in de radiator.

**JAGA ACO**

**JAGA TPT**

**JAGA BMS**

D09

D01

D03

## STANDAARD: AANSLUITING LINKS OF RECHTS MET BEDIENING BENEDEN

Links of rechts beneden, naar de wand of naar de vloer. Wandaansluiting via onderzijde bekleding, of volledig onzichtbaar binnen de bekleding.

De installateur kan de warmtewisselaar draaien voor een rechtse of linkse aansluiting.

Mogelijke Euroconus aansluitsets: 101, 102, 103, 104, 181, 182, 183, 184, 222, 225, 226, 282, 285

Mogelijke M24 aansluitsets: 11, 12, 13, 14, 25

### Voorbeeld aansluiting rechts (standaard)

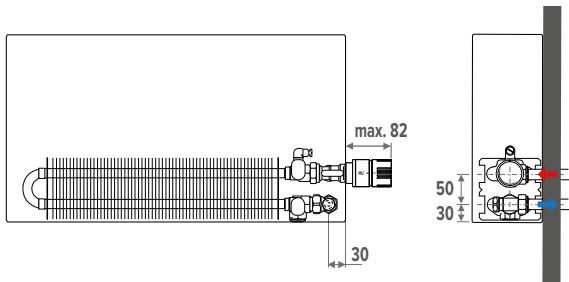

### Voorbeeld aansluiting links

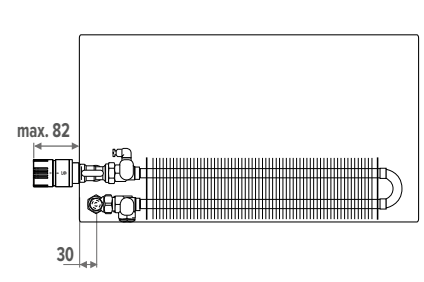

## AANSLUITING LINKS OF RECHTS MET BEDIENING BOVENAAN

De code van de radiator aanvullen met 30 (links) of 60 (rechts). VB. STRW 035 050 06 XXX D09 60

Mogelijke Euroconus aansluitsets: 115, 116, 117, 118

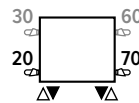

### Voorbeeld aansluiting rechts (standaard)

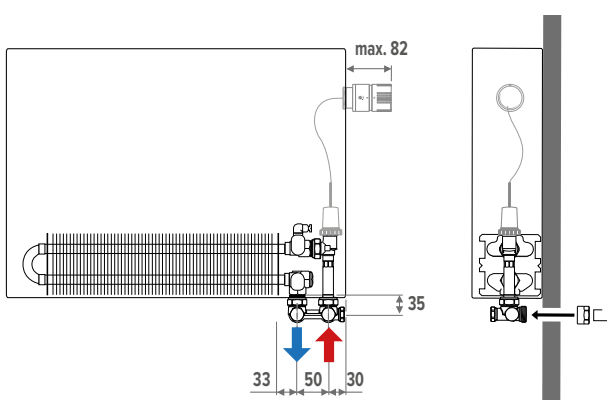

### Voorbeeld aansluiting links

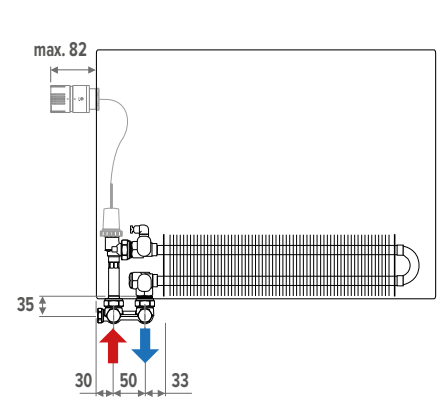

## AANSLUITING LINKS OF RECHTS MET BEDIENING OP AFSTAND

De code van de radiator aanvullen met 00 (dichte zijanten). VB. STRW.035 050 06 XXX D01 00

Mogelijke Euroconus aansluitsets: 111, 112, 113, 114

Mogelijke M24 aansluitsets: 28, 29

### Voorbeeld aansluiting rechts (standaard)

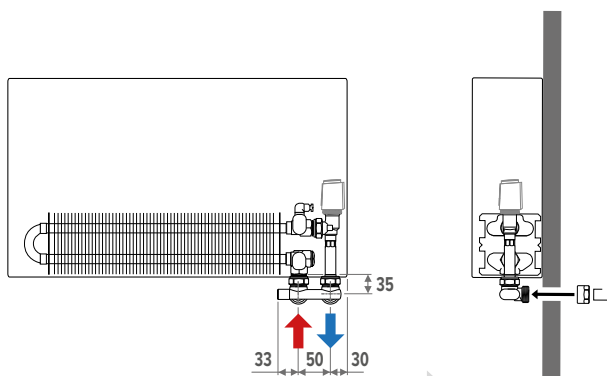

### Voorbeeld aansluiting links

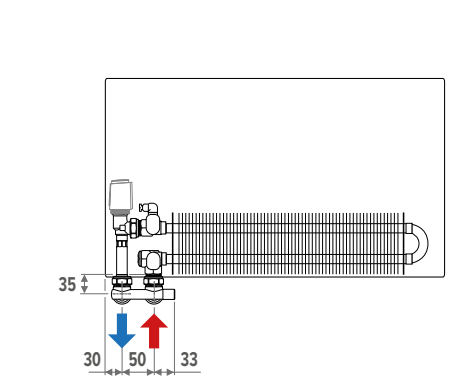

Wanneer een Hybrid toestel met Jaga TPT sturing uitgerust wordt met een thermo-elektrische ventielmotor die op de interne elektronica aangesloten is, dan neemt het toestel de functie van kamerthermostaat over. Het toestel zal dan zelf op basis van kamertemperatuurmeting het waterdebiet door het toestel in- of uitschakelen.

Wanneer men de kamertemperatuur wenst in te stellen via een kamerthermostaat, zonesturing, domotica of ander systeem dat het waterdebiet door het toestel in- of uitschakelt, dan dient men geen thermo-elektrische ventielmotor op de interne controller aan te sluiten. De Jaga TPT sturing zal dan enkel de ventilatoren modulerend in toerental sturen op basis van de gemeten kamer- en watertemperatuur.



## Naar de wand - AANVOER BUITENZIJD Met Jaga H-ventiel

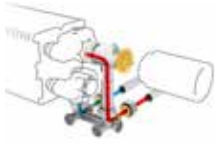

set **103** KVS: 0.8  
TWEEPIJP / EENPIJP

<b>Verwarmen *</b>		
COLO HBSW AC 4...	AC	
COLO HBSW AW 4...	AW	
COLO HBSW AS 4...	AS	
COLO HBSW AB 4...	AB	
<b>Verwarmen en koelen</b>		
COLO HBSW HC 4...	HC	

code klemkoppeling invullen

## Met Gampper Vario DP Dynamisch ventiel



set **183** automatische debietregeling (20 - 340 l/u)  
TWEEPIJP

<b>Verwarmen *</b>		
COLO GASW AC 4...	AC	
COLO GASW AW 4...	AW	
COLO GASW AS 4...	AS	
COLO GASW AB 4...	AB	
<b>Verwarmen en koelen</b>		
COLO GASW HC 4...	HC	

code klemkoppeling invullen

## Naar de vloer - AANVOER BUITENZIJD Met Jaga H-ventiel

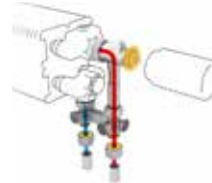

set **104** KVS: 0.8  
TWEEPIJP / EENPIJP

<b>Verwarmen *</b>		
COLO HBSF AC 4...	AC	
COLO HBSF AW 4...	AW	
COLO HBSF AS 4...	AS	
COLO HBSF AB 4...	AB	
<b>Verwarmen en koelen</b>		
COLO HBSF HC 4...	HC	

code klemkoppeling invullen

## Met Gampper Vario DP Dynamisch ventiel

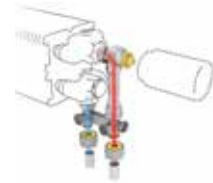

set **184** automatische debietregeling (20 - 340 l/u)  
TWEEPIJP

<b>Verwarmen *</b>		
COLO GASF AC 4...	AC	
COLO GASF AW 4...	AW	
COLO GASF AS 4...	AS	
COLO GASF AB 4...	AB	
<b>Verwarmen en koelen</b>		
COLO GASF HC 4...	HC	

code klemkoppeling invullen

## Naar de wand - AANVOER BINNENZIJD Met Jaga Crossflow ventiel



set **101** KVS: 0.8  
TWEEPIJP

<b>Verwarmen *</b>		
COLO HBCW AC 4...	AC	
COLO HBCW AW 4...	AW	
COLO HBCW AS 4...	AS	
COLO HBCW AB 4...	AB	
<b>Verwarmen en koelen</b>		
COLO HBCW HC 4...	HC	

code klemkoppeling invullen

## Met Gampper Vario DP Dynamisch ventiel



set **181** automatische debietregeling (20 - 340 l/u)  
TWEEPIJP

<b>Verwarmen *</b>		
COLO GACW AC 4...	AC	
COLO GACW AW 4...	AW	
COLO GACW AS 4...	AS	
COLO GACW AB 4...	AB	
<b>Verwarmen en koelen</b>		
COLO GACW HC 4...	HC	

code klemkoppeling invullen

## Naar de vloer - AANVOER BINNENZIJD Met Jaga Crossflow ventiel

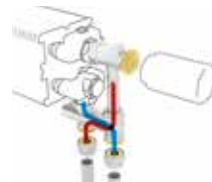

set **102** KVS: 0.8  
TWEEPIJP

<b>Verwarmen *</b>		
COLO HBCF AC 4...	AC	
COLO HBCF AW 4...	AW	
COLO HBCF AS 4...	AS	
COLO HBCF AB 4...	AB	
<b>Verwarmen en koelen</b>		
COLO HBCF HC 4...	HC	

code klemkoppeling invullen

## Met Gampper Vario DP Dynamisch ventiel



set **182** automatische debietregeling (20 - 340 l/u)  
TWEEPIJP

<b>Verwarmen *</b>		
COLO GACF AC 4...	AC	
COLO GACF AW 4...	AW	
COLO GACF AS 4...	AS	
COLO GACF AB 4...	AB	
<b>Verwarmen en koelen</b>		
COLO GACF HC 4...	HC	

code klemkoppeling invullen

## Naar de wand - BINNEN DE BEKLEDING Met Jaga ventiel



set **225** KVS: 0.8  
TWEEPIJP

<b>Verwarmen *</b>		
COLO SW2 AC 4...	AC	
COLO SW2 AW 4...	AW	
COLO SW2 AS 4...	AS	
COLO SW2 AB 4...	AB	
<b>Verwarmen en koelen</b>		
COLO SW2 HC 4...	HC	

code klemkoppeling invullen

## Met Gampper Vario DP Dynamisch ventiel



set **285** automatische debietregeling (20 - 340 l/u)  
TWEEPIJP

<b>Verwarmen *</b>		
COLO GW2 AC 4...	AC	
COLO GW2 AW 4...	AW	
COLO GW2 AS 4...	AS	
COLO GW2 AB 4...	AB	
<b>Verwarmen en koelen</b>		
COLO GW2 HC 4...	HC	

code klemkoppeling invullen

## Met 2 retourventielen



set **226** TWEEPIJP

COLO LOA 00 4...		
code klemkoppeling invullen		

\* Ook geschikt voor Light Cooling in combinatie met adapter 5090 1114.



## Klemkoppelingen 3/4" Euroconus

DUNWANDIG METAAL		KUNSTSTOF OF VPE/ALU	
CODE	Buis Ø	CODE	Buis Ø
112	12/1	612	12/2
114	14/1	614	14/2
115	15/1	616	16/2
116	16/1	618	18/2
118	18/1	619	16/1.5
		620	20/2

Uitgebreide informatie van de ventielen, zie brochure "Aansluitsets & ventielen"

# STRADA HYBRID

# HOOGTE 035

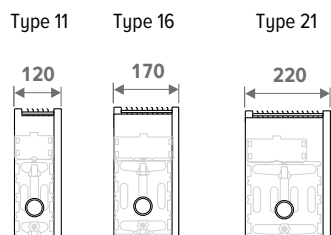

HOOGTE H cm	LENGTE L cm	TYPE T	STAND	KOELLEN (niet condenserend) Kamertemperatuur 27°C					GELUIDSDRUKNIVEAU		GEWICHT kg	WATERHOUD L	BESTELCODE
				16/18 Watt	35/30 Watt	45/40 Watt	50/45 Watt	55/45 Watt	dB(A)	ENERGIEVERBRUIK Watt			
STRW 035 050	110	11	1	148	190	366	457	499	26.0	3.6	0.7	STRW 035 050 11 XXX DDD	
			2	158	203	391	489	534	30.0	4.1			
			3	185	237	457	571	624	38.8	5.1			
	160	11	1	---	---	---	---	---	---	---	---	---	
			2	---	---	---	---	---	---	---			
			3	---	---	---	---	---	---	---			
	210	11	1	---	---	---	---	---	---	---	---	---	
			2	---	---	---	---	---	---	---			
			3	---	---	---	---	---	---	---			
	060	110	11	1	191	246	474	592	647	26.0	4.8	0.8	STRW 035 060 11 XXX DDD
				2	205	263	508	634	693	30.0	5.4		
				3	242	311	601	750	820	40.0	6.8		
		160	11	1	214	301	581	726	793	26.0	4.8	1.2	STRW 035 060 16 XXX DDD
				2	230	323	624	779	851	30.0	5.5		
				3	305	428	826	1031	1126	41.1	7.2		
		210	11	1	234	416	779	963	1048	26.0	4.8	1.6	STRW 035 060 21 XXX DDD
				2	251	447	836	1034	1125	30.0	5.5		
				3	332	591	1106	1368	1488	41.1	7.2		
070		110	11	1	234	301	580	724	791	26.0	5.5	0.9	STRW 035 070 11 XXX DDD
				2	251	322	622	777	849	30.0	5.9		
				3	300	385	743	928	1014	41.0	7.9		
		160	11	1	220	350	676	844	922	26.0	5.1	1.4	STRW 035 070 16 XXX DDD
				2	236	376	725	906	990	30.0	5.6		
				3	312	498	960	1199	1310	41.1	7.2		
		210	11	1	240	456	854	1056	1149	26.0	5.1	1.9	STRW 035 070 21 XXX DDD
				2	258	490	917	1134	1234	30.0	5.6		
				3	341	648	1214	1501	1633	41.1	7.2		
	080	110	11	1	276	355	684	854	933	26.0	6.3	1.1	STRW 035 080 11 XXX DDD
				2	296	381	735	917	1002	30.0	6.8		
				3	358	460	887	1107	1210	41.8	9.1		
		160	11	1	312	439	847	1058	1156	26.0	6.0	1.6	STRW 035 080 16 XXX DDD
				2	335	471	908	1134	1239	30.0	6.7		
				3	450	632	1219	1522	1663	42.4	9.0		
		210	11	1	341	606	1135	1404	1527	26.0	6.0	2.1	STRW 035 080 21 XXX DDD
				2	366	650	1217	1505	1638	30.0	6.7		
				3	490	873	1634	2020	2197	42.4	9.0		
090		110	11	1	317	408	786	982	1072	26.0	6.7	1.2	STRW 035 090 11 XXX DDD
				2	341	438	846	1056	1154	30.0	7.4		
				3	415	534	1029	1286	1405	42.4	10.3		
		160	11	1	358	503	970	1211	1323	26.0	7.0	1.8	STRW 035 090 16 XXX DDD
				2	383	539	1039	1298	1418	30.0	7.7		
				3	522	734	1415	1767	1931	43.3	10.7		
		210	11	1	390	694	1300	1607	1749	26.0	7.0	2.4	STRW 035 090 21 XXX DDD
				2	418	744	1393	1722	1874	30.0	7.7		
				3	570	1013	1897	2345	2552	43.3	10.7		
	100	110	11	1	358	460	887	1107	1210	26.0	7.8	1.3	STRW 035 100 11 XXX DDD
				2	385	495	955	1193	1303	30.0	8.7		
				3	473	608	1173	1465	1600	43.0	12.2		
		160	11	1	403	566	1092	1364	1490	26.0	7.0	2.0	STRW 035 100 16 XXX DDD
				2	431	606	1169	1460	1595	30.0	7.7		
				3	595	836	1612	2013	2199	44.1	10.7		
		210	11	1	439	782	1464	1809	1969	26.0	7.0	2.7	STRW 035 100 21 XXX DDD
				2	471	837	1567	1937	2108	30.0	7.7		
				3	649	1154	2160	2671	2906	44.1	10.7		
110		110	11	1	401	516	995	1242	1357	26.0	8.4	1.5	STRW 035 110 11 XXX DDD
				2	432	556	1072	1339	1462	30.0	9.3		
				3	531	682	1315	1643	1795	43.5	14.0		
		160	11	1	408	613	1183	1477	1614	26.0	7.9	2.2	STRW 035 110 16 XXX DDD
				2	437	657	1267	1582	1728	30.0	8.8		
				3	602	905	1746	2181	2383	44.1	12.5		
		210	11	1	446	821	1536	1899	2067	26.0	7.9	2.9	STRW 035 110 21 XXX DDD
				2	477	879	1645	2034	2213	30.0	8.8		
				3	658	1211	2268	2804	3051	44.1	12.5		
	120	110	11	1	437	562	1084	1354	1479	26.0	8.9	1.6	STRW 035 120 11 XXX DDD
				2	473	607	1171	1463	1598	30.0	9.9		
				3	589	756	1459	1822	1990	44.0	14.8		
		160	11	1	496	698	1346	1681	1836	26.0	8.7	2.4	STRW 035 120 16 XXX DDD
				2	532	747	1441	1800	1966	30.0	9.8		
				3	740	1039	2005	2504	2735	44.8	14.3		
		210	11	1	542	963	1804	2230	2426	26.0	8.7	3.2	STRW 035 120 21 XXX DDD
				2	580	1032	1932	2388	2598	30.0	9.8		
				3	807	1435	2687	3322	3615	44.8	14.3		

Afgiftes gemeten volgens EN 16430  
 \*Geluidsmeting volgens ISO 3741:2010, op 2 m van het  
 toestel en met een aangenomen ruimtedemping van  
 8 dB(A) / inhoud lokaal 100 m³ / nagalmtijd 0.5 sec.

kleurcode invullen |  
 code sturing invullen |

# STRADA HYBRID

# HOOGTE 035

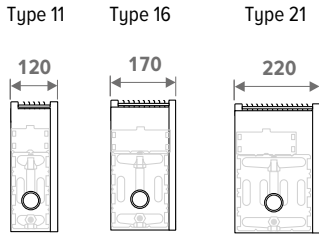

HOOGTE H cm	LENGTE L cm	TYPE T	STAND	KOELEN (niet condenserend) Kamertemperatuur 27°C					VERWARMEN Kamertemperatuur 20°C					GELUIDSDRUKNIVEAU		GEWICHT kg	WATERINHOUD L	BESTELCODE
				16/18 Watt	35/30 Watt	45/40 Watt	50/45 Watt	55/45 Watt	dB(A)	Watt								
STRW 035	140	11	1	515	662	1277	1595	1743	26.0	10.1	1.6	STRW 035 140 11 XXX DDD						
			2	558	717	1383	1728	1887	30.0	11.2								
			3	704	905	1745	2179	2380	44.8	17.5								
		16	1	589	827	1596	1993	2177	26.0	9.6	2.4	STRW 035 140 16 XXX DDD						
			2	630	886	1709	2134	2332	30.0	10.5								
			3	885	1243	2398	2995	3272	45.4	16.1								
	21	1	642	1143	2139	2645	2877	26.0	9.6	3.2	STRW 035 140 21 XXX DDD							
		2	688	1224	2291	2832	3082	30.0	10.5									
		3	965	1717	3214	3974	4324	45.4	16.1									
	160	11	1	592	760	1467	1832	2001	26.0	11.0	2.1	STRW 035 060 11 XXX DDD						
			2	642	825	1592	1988	2172	30.0	12.4								
			3	819	1053	2031	2536	2771	45.5	19.2								
		16	1	676	951	1834	2290	2502	26.0	11.5	3.2	STRW 035 060 16 XXX DDD						
			2	722	1015	1958	2445	2671	30.0	12.8								
			3	1030	1447	2791	3486	3808	46.4	19.6								
		21	1	738	1313	2458	3039	3307	26.0	11.5	4.3	STRW 035 060 21 XXX DDD						
			2	788	1402	2624	3245	3530	30.0	12.8								
			3	1123	1998	3741	4625	5032	46.4	19.6								
		180	11	1	675	867	1673	2090	2283	26.0	12.2	2.4	STRW 035 070 11 XXX DDD					
				2	733	942	1816	2268	2478	30.0	13.7							
				3	935	1201	2317	2893	3161	46.0	22.0							
	16		1	686	1042	2011	2511	2743	26.0	11.5	3.6	STRW 035 070 16 XXX DDD						
			2	733	1113	2147	2681	2929	30.0	12.8								
			3	1045	1586	3060	3821	4175	46.4	19.6								
21	1		750	1388	2599	3214	3497	26.0	11.5	4.8	STRW 035 070 21 XXX DDD							
	2		801	1482	2775	3431	3733	30.0	12.8									
	3		1142	2113	3956	4891	5322	46.4	19.6									
200	11		1	741	952	1836	2293	2505	26.0	13.4	2.7	STRW 035 080 11 XXX DDD						
			2	807	1037	2001	2499	2730	30.0	14.8								
			3	1050	1349	2603	3250	3551	46.5	24.0								
	16	1	868	1220	2352	2938	3210	26.0	13.2	4.0	STRW 035 080 16 XXX DDD							
		2	914	1285	2479	3096	3382	30.0	14.7									
		3	1320	1855	3577	4468	4881	47.1	23.5									
	21	1	947	1684	3153	3898	4242	26.0	13.2	5.3	STRW 035 080 21 XXX DDD							
		2	998	1775	3322	4108	4469	30.0	14.7									
		3	1440	2561	4795	5928	6450	47.1	23.5									
	220	11	1	809	1040	2005	2505	2736	26.0	13.4	2.9	STRW 035 090 11 XXX DDD						
			2	884	1136	2191	2737	2990	30.0	14.8								
			3	1166	1498	2889	3608	3941	46.9	24.0								
16		1	963	1354	2612	3262	3563	26.0	15.5	4.4	STRW 035 090 16 XXX DDD							
		2	1003	1003	2721	3398	3712	30.0	16.8									
		3	1465	2058	3970	4959	5417	47.8	27.5									
21		1	1051	1870	3501	4328	4709	26.0	15.5	5.9	STRW 035 090 21 XXX DDD							
		2	1095	1948	3646	4508	4905	30.0	16.8									
		3	1598	2843	5322	6579	7159	47.8	27.5									
240		11	1	877	1127	2174	2715	2967	26.0	14.8	3.2	STRW 035 100 11 XXX DDD						
			2	961	1235	2382	2975	3250	30.0	16.6								
			3	1281	1646	3175	3965	4331	47.2	28.0								
	16	1	1059	1488	2871	3586	3917	26.0	16.4	4.8	STRW 035 100 16 XXX DDD							
		2	1098	1543	2975	3716	3250	30.0	17.7									
		3	1610	2262	4364	5450	5954	48.1	29.7									
	21	1	1155	2056	3848	4758	5177	26.0	16.4	6.4	STRW 035 100 21 XXX DDD							
		2	1197	2130	3988	4931	5365	30.0	17.7									
		3	1756	3124	5849	7231	7868	48.1	29.7									
	260	11	1	950	1220	2353	2939	3211	26.0	16.2	3.5	STRW 035 120 11 XXX DDD						
			2	1047	1346	2596	3241	3541	30.0	18.6								
			3	1396	1794	3461	4322	4722	47.8	31.4								
16		1	1069	1580	3048	3806	4158	26.0	16.4	5.1	STRW 035 120 16 XXX DDD							
		2	1108	1638	3159	3945	4310	30.0	17.7									
		3	1625	2401	4632	5785	6320	48.1	29.7									
21		1	1168	2131	3990	4933	5367	26.0	16.4	6.9	STRW 035 120 21 XXX DDD							
		2	1210	2209	4135	5112	5562	30.0	17.7									
		3	1774	3239	6064	7497	8157	48.1	29.7									
280		11	1	956	1286	2481	3098	3385	26.0	16.2	3.7	STRW 035 140 11 XXX DDD						
			2	1056	1420	2739	3421	3737	30.0	18.6								
			3	1406	1892	3649	4557	4978	47.8	31.4								
	16	1	1250	1757	3390	4233	4625	26.0	19.3	5.5	STRW 035 140 16 XXX DDD							
		2	1278	1797	3465	4328	4728	30.0	20.4									
		3	1900	2670	5150	6431	7026	48.9	34.5									
	21	1	1364	2427	4543	5617	6112	26.0	19.3	7.4	STRW 035 140 21 XXX DDD							
		2	1395	2481	4645	5743	6249	30.0	20.4									
		3	2072	3687	6903	8534	9286	48.9	34.5									

Afmetingen gemeten volgens EN 16430  
 \*Geluidsmeting volgens ISO 3741:2010, op 2 m van het toestel en met een aangenomen ruimtedemping van 8 dB(A) / inhoud lokaal 100 m³ / nagalmtijd 0.5 sec.

kleurcode invullen |  
 code sturing invullen |

# STRADA HYBRID

# HOOGTE 050

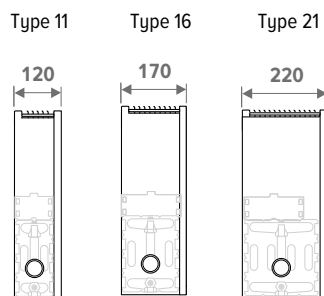

HOOGTE H cm	LENGTE L cm	TYPE T	STAND	KOELEN (niet condenserend) Kamertemperatuur 27°C					VERWARMEN Kamertemperatuur 20°C		GELUIDSDRUKNIVEAU		GEWICHT kg	WATERHOUD L	BESTELCODE
				16/18 Watt	35/30 Watt	45/40 Watt	50/45 Watt	55/45 Watt	dB(A)	ENERGIEVERBRUIK Watt					
STRW 050 050	11	11	1	148	190	366	457	499	26.0	3.6	0.7	STRW 050 050 11 XXX DDD			
			2	158	203	391	489	534	30.0	4.1					
			3	185	237	457	571	624	38.8	5.1					
	16	11	1	---	---	---	---	---	---	---	---	---			
			2	---	---	---	---	---	---	---					
			3	---	---	---	---	---	---	---					
	21	11	1	---	---	---	---	---	---	---	---	---			
			2	---	---	---	---	---	---	---					
			3	---	---	---	---	---	---	---					
	060	11	11	1	191	246	474	592	647	26.0	4.8	0.8	STRW 050 060 11 XXX DDD		
				2	205	263	508	634	693	30.0	5.4				
				3	242	311	601	750	820	40.0	6.8				
		16	11	1	214	301	581	726	793	26.0	4.8	1.2	STRW 050 060 16 XXX DDD		
				2	230	323	624	779	851	30.0	5.5				
				3	305	428	826	1031	1126	41.1	7.2				
		21	11	1	234	416	779	963	1048	26.0	4.8	1.6	STRW 050 060 21 XXX DDD		
				2	251	447	836	1034	1125	30.0	5.5				
				3	332	591	1106	1368	1488	41.1	7.2				
070		11	11	1	234	301	580	724	791	26.0	5.5	0.9	STRW 050 070 11 XXX DDD		
				2	251	322	622	777	849	30.0	5.9				
				3	300	385	743	928	1014	41.0	7.9				
		16	11	1	220	350	676	844	922	26.0	5.1	1.4	STRW 050 070 16 XXX DDD		
				2	236	376	725	906	990	30.0	5.6				
				3	312	498	960	1199	1310	41.1	7.2				
		21	11	1	240	456	854	1056	1149	26.0	5.1	1.9	STRW 050 070 21 XXX DDD		
				2	258	490	917	1134	1234	30.0	5.6				
				3	341	648	1214	1501	1633	41.1	7.2				
	080	11	11	1	276	355	684	854	933	26.0	6.3	1.1	STRW 050 080 11 XXX DDD		
				2	296	381	735	917	1002	30.0	6.8				
				3	358	460	887	1107	1210	41.8	9.1				
		16	11	1	312	439	847	1058	1156	26.0	6.0	1.6	STRW 050 080 16 XXX DDD		
				2	335	471	908	1134	1239	30.0	6.7				
				3	450	632	1219	1522	1663	42.4	9.0				
		21	11	1	341	456	854	1056	1149	26.0	6.0	2.1	STRW 050 080 21 XXX DDD		
				2	366	490	917	1134	1234	30.0	6.7				
				3	490	873	1634	2020	2197	42.4	9.0				
090		11	11	1	317	355	684	854	933	26.0	6.7	1.2	STRW 050 090 11 XXX DDD		
				2	341	381	735	917	1002	30.0	7.4				
				3	415	534	1029	1286	1405	42.4	10.3				
		16	11	1	358	503	970	1211	1323	26.0	7.0	1.8	STRW 050 090 16 XXX DDD		
				2	383	539	1039	1298	1418	30.0	7.7				
				3	522	734	1415	1767	1931	43.3	10.7				
		21	11	1	390	694	1300	1607	1749	26.0	7.0	2.4	STRW 050 090 21 XXX DDD		
				2	418	744	1393	1722	1874	30.0	7.7				
				3	570	1013	1897	2345	2552	43.3	10.7				
	100	11	11	1	358	460	887	1107	1210	26.0	7.8	1.3	STRW 050 100 11 XXX DDD		
				2	385	495	955	1193	1303	30.0	8.7				
				3	473	608	1173	1465	1600	43.0	12.2				
		16	11	1	403	566	1092	1364	1490	26.0	7.0	2.0	STRW 050 100 16 XXX DDD		
				2	431	606	1169	1460	1595	30.0	7.7				
				3	595	836	1612	2013	2199	44.1	10.7				
		21	11	1	439	782	1464	1809	1969	26.0	7.0	2.7	STRW 050 100 21 XXX DDD		
				2	471	837	1567	1937	2108	30.0	7.7				
				3	649	1154	2160	2671	2906	44.1	10.7				
110		11	11	1	358	516	995	1242	1357	26.0	8.4	1.5	STRW 050 110 11 XXX DDD		
				2	385	556	1072	1339	1462	30.0	9.3				
				3	531	682	1315	1643	1795	43.5	14.0				
		16	11	1	403	613	1183	1477	1614	26.0	7.9	2.2	STRW 050 110 16 XXX DDD		
				2	431	657	1267	1582	1728	30.0	8.8				
				3	602	905	1746	2181	2383	44.1	12.5				
		21	11	1	437	821	1536	1899	2067	26.0	7.9	2.9	STRW 050 110 21 XXX DDD		
				2	473	879	1645	2034	2213	30.0	8.8				
				3	658	1211	2268	2804	3051	44.1	12.5				
	120	11	11	1	437	562	1084	1354	1479	26.0	8.9	1.6	STRW 050 120 11 XXX DDD		
				2	473	607	1171	1463	1598	30.0	9.9				
				3	589	756	1459	1822	1990	44.0	14.8				
		16	11	1	496	698	1346	1681	1836	26.0	8.7	2.4	STRW 050 120 16 XXX DDD		
				2	532	747	1441	1800	1966	30.0	9.8				
				3	740	1039	2005	2504	2735	44.8	14.3				
		21	11	1	542	963	1804	2230	2426	26.0	8.7	3.2	STRW 050 120 21 XXX DDD		
				2	580	1032	1932	2388	2598	30.0	9.8				
				3	807	1435	2687	3322	3615	44.8	14.3				

Afgiftes gemeten volgens EN 16430  
 \*Geluidsmeting volgens ISO 3741:2010, op 2 m van het  
 toestel en met een aangenomen ruimtedemping van  
 8 dB(A) / inhoud lokaal 100 m<sup>3</sup> / nagalmtijd 0.5 sec.

kleurcode invullen |  
 code sturing invullen |

# STRADA HYBRID

# HOOGTE 050

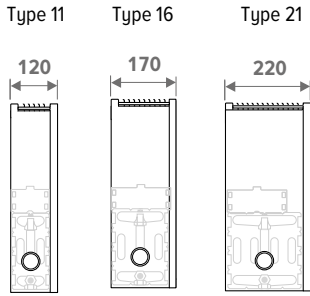

HOOGTE H cm	LENGTE L cm	TYPE T	STAND	KOELEN (niet condenserend) Kamertemperatuur 27°C					VERWARMEN Kamertemperatuur 20°C					GELUIDSDRUKNIVEAU		GEWICHT kg	WATERINHOUD L	BESTELCODE
				16/18 Watt	35/30 Watt	45/40 Watt	50/45 Watt	55/45 Watt	dB(A)	Watt								
STRW 050	140	11	1	515	662	1277	1595	1743	26.0	10.1	1.6	STRW 050 140 11 XXX DDD						
			2	558	717	1383	1728	1887	30.0	11.2								
			3	704	905	1745	2179	2380	44.8	17.5								
		16	1	589	827	1596	1993	2177	26.0	9.6	2.4	STRW 050 140 16 XXX DDD						
			2	630	886	1709	2134	2332	30.0	10.5								
			3	885	1243	2398	2995	3272	45.4	16.1								
	21	1	688	1143	2139	2645	2877	26.0	9.6	3.2	STRW 050 140 21 XXX DDD							
		2	965	1224	2291	2832	3082	30.0	10.5									
		3	965	1717	3214	3974	4324	45.4	16.1									
	160	11	1	592	760	1467	1832	2001	26.0	11.0	2.1	STRW 050 060 11 XXX DDD						
			2	642	825	1592	1988	2172	30.0	12.4								
			3	819	1053	2031	2536	2771	45.5	19.2								
		16	1	676	951	1834	2290	2502	26.0	11.5	3.2	STRW 050 060 16 XXX DDD						
			2	722	1015	1958	2445	2671	30.0	12.8								
			3	1030	1447	2791	3486	3808	46.4	19.6								
		21	1	738	1313	2458	3039	3307	26.0	11.5	4.3	STRW 050 060 21 XXX DDD						
			2	788	1402	2624	3245	3530	30.0	12.8								
			3	1123	1998	3741	4625	5032	46.4	19.6								
		180	11	1	675	867	1673	2090	2283	26.0	12.2	2.4	STRW 050 070 11 XXX DDD					
				2	733	942	1816	2268	2478	30.0	13.7							
				3	935	1201	2317	2893	3161	46.0	22.0							
	16		1	686	1220	2352	2938	3210	26.0	11.5	3.6	STRW 050 070 16 XXX DDD						
			2	733	1285	2479	3096	3382	30.0	12.8								
			3	1045	1586	3060	3821	4175	46.4	19.6								
21	1		750	1388	2599	3214	3497	26.0	11.5	4.8	STRW 050 070 21 XXX DDD							
	2		801	1482	2775	3431	3733	30.0	12.8									
	3		1142	2113	3956	4891	5322	46.4	19.6									
200	11		1	741	952	1836	2293	2505	26.0	13.4	2.7	STRW 050 080 11 XXX DDD						
			2	807	1037	2001	2499	2730	30.0	14.8								
			3	1050	1349	2603	3250	3551	46.5	24.0								
	16	1	686	1220	2352	2938	3210	26.0	13.2	4.0	STRW 050 080 16 XXX DDD							
		2	733	1285	2479	3096	3382	30.0	14.7									
		3	1320	1855	3577	4468	4881	47.1	23.5									
	21	1	750	1684	3153	3898	4242	26.0	13.2	5.3	STRW 050 080 21 XXX DDD							
		2	801	1775	3322	4108	4469	30.0	14.7									
		3	1440	2561	4795	5928	6450	47.1	23.5									
	220	11	1	809	1127	2174	2715	2967	26.0	13.4	2.9	STRW 050 090 11 XXX DDD						
			2	884	1235	2382	2975	3250	30.0	14.8								
			3	1166	1498	2889	3608	3941	46.9	24.0								
16		1	963	1354	2612	3262	3563	26.0	15.5	4.4	STRW 050 090 16 XXX DDD							
		2	1003	1003	2721	3398	3712	30.0	16.8									
		3	1465	2058	3970	4959	5417	47.8	27.5									
21		1	1051	1870	3501	4328	4709	26.0	15.5	5.9	STRW 050 090 21 XXX DDD							
		2	1095	1948	3646	4508	4905	30.0	16.8									
		3	1598	2843	5322	6579	7159	47.8	27.5									
240		11	1	877	1127	2174	2715	2967	26.0	14.8	3.2	STRW 050 100 11 XXX DDD						
			2	961	1235	2382	2975	3250	30.0	16.6								
			3	1281	1646	3175	3965	4331	47.2	28.0								
	16	1	1059	1488	2871	3586	3917	26.0	16.4	4.8	STRW 050 100 16 XXX DDD							
		2	1098	1543	2975	3716	3250	30.0	17.7									
		3	1610	2262	4364	5450	5954	48.1	29.7									
	21	1	1155	2056	3848	4758	5177	26.0	16.4	6.4	STRW 050 100 21 XXX DDD							
		2	1197	2130	3988	4931	5365	30.0	17.7									
		3	1756	3124	5849	7231	7868	48.1	29.7									
	260	11	1	950	1220	2353	2939	3211	26.0	16.2	3.5	STRW 050 120 11 XXX DDD						
			2	1047	1346	2596	3241	3541	30.0	18.6								
			3	1396	1794	3461	4322	4722	47.8	31.4								
16		1	1069	1488	2871	3586	3917	26.0	16.4	5.1	STRW 050 120 16 XXX DDD							
		2	1108	1543	2975	3716	3250	30.0	17.7									
		3	1625	2401	4632	5785	6320	48.1	29.7									
21		1	1168	2131	3990	4933	5367	26.0	16.4	6.9	STRW 050 120 21 XXX DDD							
		2	1210	2209	4135	5112	5562	30.0	17.7									
		3	1774	3239	6064	7497	8157	48.1	29.7									
280		11	1	956	1286	2481	3098	3385	26.0	16.2	3.7	STRW 050 140 11 XXX DDD						
			2	1056	1420	2739	3421	3737	30.0	18.6								
			3	1406	1892	3649	4557	4978	47.8	31.4								
	16	1	1250	1757	3390	4233	4625	26.0	19.3	5.5	STRW 050 140 16 XXX DDD							
		2	1278	1797	3465	4328	4728	30.0	20.4									
		3	1900	2670	5150	6431	7026	48.9	34.5									
	21	1	1364	2427	4543	5617	6112	26.0	19.3	7.4	STRW 050 140 21 XXX DDD							
		2	1395	2481	4645	5743	6249	30.0	20.4									
		3	2072	3687	6903	8534	9286	48.9	34.5									

Afgiftes gemeten volgens EN 16430  
 \*Geluidsmeting volgens ISO 3741:2010, op 2 m van het  
 toestel en met een aangenomen ruimtedemping van  
 8 dB(A) / inhoud lokaal 100 m³ / nagalmtijd 0.5 sec.

kleurcode invullen |  
 code sturing invullen |

# STRADA HYBRID

# HOOGTE 065

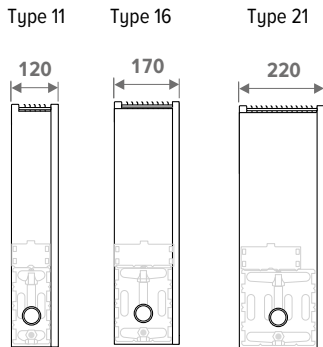

HOOGTE H cm	LENGTE L cm	TYPE T	STAND	KOELLEN (niet condensierend) Kamertemperatuur 27°C					GELUIDSDRUKNIVEAU		ENERGIEVERBRUIK Watt	GEWICHT kg	WATERINHOUD L	BESTELCODE
				16/18 Watt	35/30 Watt	45/40 Watt	50/45 Watt	55/45 Watt	dB(A)					
STRW 065	050	11	1	136	190	366	457	499	26.0	3.6	0.7	STRW 065 050 11 XXX DDD		
			2	146	203	391	489	534	30.0	4.1				
			3	171	237	457	571	624	38.8	5.1				
	16	1	---	---	---	---	---	---	---	---	---	---		
		2	---	---	---	---	---	---	---	---	---	---		
		3	---	---	---	---	---	---	---	---	---	---		
	21	1	---	---	---	---	---	---	---	---	---	---		
		2	---	---	---	---	---	---	---	---	---	---		
		3	---	---	---	---	---	---	---	---	---	---		
	060	11	11	1	177	246	474	592	647	26.0	4.8	0.8	STRW 065 060 11 XXX DDD	
				2	190	263	508	634	693	30.0	5.4			
				3	224	1447	1447	1447	1447	40.0	6.8			
		16	1	198	301	581	726	793	26.0	4.8	1.2	STRW 065 060 16 XXX DDD		
			2	213	323	624	779	851	30.0	5.5				
			3	282	1989	1989	1989	1989	41.1	7.2				
		21	1	216	416	779	963	1048	26.0	4.8	1.6	STRW 065 060 21 XXX DDD		
			2	232	447	836	1034	1125	30.0	5.5				
			3	307	591	1106	1368	1488	41.1	7.2				
070		11	11	1	216	301	580	724	791	26.0	5.5	0.9	STRW 065 070 11 XXX DDD	
				2	232	322	622	777	849	30.0	5.9			
				3	278	385	743	928	1014	41.0	7.9			
		16	1	203	350	676	844	922	26.0	5.1	1.4	STRW 065 070 16 XXX DDD		
			2	218	376	725	906	990	30.0	5.6				
			3	289	498	960	1199	1310	41.1	7.2				
		21	1	222	456	854	1056	1149	26.0	5.1	1.9	STRW 065 070 21 XXX DDD		
			2	239	490	917	1134	1234	30.0	5.6				
			3	316	648	1214	1501	1633	41.1	7.2				
	080	11	11	1	255	355	684	854	933	26.0	6.3	1.1	STRW 065 080 11 XXX DDD	
				2	274	381	735	917	1002	30.0	6.8			
				3	331	460	887	1107	1210	41.8	9.1			
		16	1	289	439	847	1058	1156	26.0	6.0	1.6	STRW 065 080 16 XXX DDD		
			2	310	471	908	1134	1239	30.0	6.7				
			3	416	632	1219	1522	1663	42.4	9.0				
		21	1	315	456	854	1056	1149	26.0	6.0	2.1	STRW 065 080 21 XXX DDD		
			2	338	490	917	1134	1234	30.0	6.7				
			3	454	873	1634	2020	2197	42.4	9.0				
090		11	11	1	293	355	684	854	933	26.0	6.7	1.2	STRW 065 090 11 XXX DDD	
				2	316	381	735	917	1002	30.0	7.4			
				3	384	534	1029	1286	1405	42.4	10.3			
		16	1	331	503	970	1211	1323	26.0	7.0	1.8	STRW 065 090 16 XXX DDD		
			2	355	539	1039	1298	1418	30.0	7.7				
			3	483	734	1415	1767	1931	43.3	10.7				
		21	1	361	694	1300	1607	1749	26.0	7.0	2.4	STRW 065 090 21 XXX DDD		
			2	387	744	1393	1722	1874	30.0	7.7				
			3	527	1013	1897	2345	2552	43.3	10.7				
	100	11	11	1	331	460	887	1107	1210	26.0	7.8	1.3	STRW 065 100 11 XXX DDD	
				2	356	495	955	1193	1303	30.0	8.7			
				3	438	608	1173	1465	1600	43.0	12.2			
		16	1	373	566	1092	1364	1490	26.0	7.0	2.0	STRW 065 100 16 XXX DDD		
			2	399	606	1169	1460	1595	30.0	7.7				
			3	550	836	1612	2013	2199	44.1	10.7				
		21	1	406	782	1464	1809	1969	26.0	7.0	2.7	STRW 065 100 21 XXX DDD		
			2	435	837	1567	1937	2108	30.0	7.7				
			3	600	1154	2160	2671	2906	44.1	10.7				
110		11	11	1	371	516	995	1242	1357	26.0	8.4	1.5	STRW 065 110 11 XXX DDD	
				2	400	556	1072	1339	1462	30.0	9.3			
				3	491	682	1315	1643	1795	43.5	14.0			
		16	1	377	613	1183	1477	1614	26.0	7.9	2.2	STRW 065 110 16 XXX DDD		
			2	404	657	1267	1582	1728	30.0	8.8				
			3	557	905	1746	2181	2383	44.1	12.5				
		21	1	412	821	1536	1899	2067	26.0	7.9	2.9	STRW 065 110 21 XXX DDD		
			2	441	879	1645	2034	2213	30.0	8.8				
			3	608	1211	2268	2804	3051	44.1	12.5				
	120	11	11	1	404	562	1084	1354	1479	26.0	8.9	1.6	STRW 065 120 11 XXX DDD	
				2	438	607	1171	1463	1598	30.0	9.9			
				3	545	756	1459	1822	1990	44.0	14.8			
		16	1	459	698	1346	1681	1836	26.0	8.7	2.4	STRW 065 120 16 XXX DDD		
			2	492	747	1441	1800	1966	30.0	9.8				
			3	685	1039	2005	2504	2735	44.8	14.3				
		21	1	501	963	1804	2230	2426	26.0	8.7	3.2	STRW 065 120 21 XXX DDD		
			2	536	1032	1932	2388	2598	30.0	9.8				
			3	746	1435	2687	3322	3615	44.8	14.3				

Afgiftes gemeten volgens EN 16430  
 \*Geluidsmeting volgens ISO 3741:2010, op 2 m van het toestel en met een aangenomen ruimtedemping van 8 dB(A) / inhoud lokaal 100 m³ / nagalmtijd 0.5 sec.

kleurcode invullen |  
 code sturing invullen |



# STRADA HYBRID

# HOOGTE 065

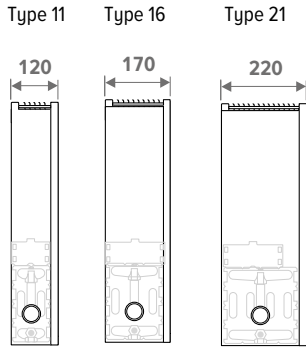

HOOGTE H cm	LENGTE L cm	TYPE T	STAND	KOELEN (niet condensend) Kamertemperatuur 27°C					VERWARMEN Kamertemperatuur 20°C					GELUIDSDRUKNIVEAU		ENERGIEVERBRUIK Watt	GEWICHT kg	WATERINHOUD L	BESTELCODE
				16/18 Watt	35/30 Watt	45/40 Watt	50/45 Watt	55/45 Watt	dB(A)										
STRW 065	140	11	1	476	662	1277	1595	1743	26.0	10.1	1.6	STRW 065 140 11 XXX DDD							
			2	516	717	1383	1728	1887	30.0	11.2									
			3	651	905	1745	2179	2380	44.8	17.5									
		16	1	545	827	1596	1993	2177	26.0	9.6	2.4	STRW 065 140 16 XXX DDD							
			2	583	886	1709	2134	2332	30.0	10.5									
			3	819	1243	2398	2995	3272	45.4	16.1									
		21	1	594	1143	2139	2645	2877	26.0	9.6	3.2	STRW 065 140 21 XXX DDD							
			2	636	1224	2291	2832	3082	30.0	10.5									
			3	893	1717	3214	3974	4324	45.4	16.1									
	160	11	1	548	760	1467	1832	2001	26.0	11.0	2.1	STRW 065 060 11 XXX DDD							
			2	594	825	1592	1988	2172	30.0	12.4									
			3	758	1053	2031	2536	2771	45.5	19.2									
		16	1	625	951	1834	2290	2502	26.0	11.5	3.2	STRW 065 060 16 XXX DDD							
			2	668	1015	1958	2445	2671	30.0	12.8									
			3	953	1447	2791	3486	3808	46.4	19.6									
		21	1	683	1313	2458	3039	3307	26.0	11.5	4.3	STRW 065 060 21 XXX DDD							
			2	729	1402	2624	3245	3530	30.0	12.8									
			3	1039	1998	3741	4625	5032	46.4	19.6									
	180	11	1	624	867	1673	2090	2283	26.0	12.2	2.4	STRW 065 070 11 XXX DDD							
			2	678	942	1816	2268	2478	30.0	13.7									
			3	865	1201	2317	2893	3161	46.0	22.0									
		16	1	635	1220	2352	2938	3210	26.0	11.5	3.6	STRW 065 070 16 XXX DDD							
			2	678	1285	2479	3096	3382	30.0	12.8									
			3	966	1586	3060	3821	4175	46.4	19.6									
21		1	694	1388	2599	3214	3497	26.0	11.5	4.8	STRW 065 070 21 XXX DDD								
		2	741	1482	2775	3431	3733	30.0	12.8										
		3	1056	2113	3956	4891	5322	46.4	19.6										
200	11	1	685	952	1836	2293	2505	26.0	13.4	2.7	STRW 065 080 11 XXX DDD								
		2	746	1037	2001	2499	2730	30.0	14.8										
		3	971	1349	2603	3250	3551	46.5	24.0										
	16	1	803	1220	2352	2938	3210	26.0	13.2	4.0	STRW 065 080 16 XXX DDD								
		2	845	1285	2479	3096	3382	30.0	14.7										
		3	1221	1855	3577	4468	4881	47.1	23.5										
	21	1	876	1684	3153	3898	4242	26.0	13.2	5.3	STRW 065 080 21 XXX DDD								
		2	923	1775	3322	4108	4469	30.0	14.7										
		3	1332	2561	4795	5928	6450	47.1	23.5										
220	11	1	748	1127	2174	2715	2967	26.0	13.4	2.9	STRW 065 090 11 XXX DDD								
		2	818	1235	2382	2975	3250	30.0	14.8										
		3	1078	1498	2889	3608	3941	46.9	24.0										
	16	1	891	1354	2612	3262	3563	26.0	15.5	4.4	STRW 065 090 16 XXX DDD								
		2	928	1003	2721	3398	3712	30.0	16.8										
		3	1355	2058	3970	4959	5417	47.8	27.5										
	21	1	972	1870	3501	4328	4709	26.0	15.5	5.9	STRW 065 090 21 XXX DDD								
		2	1013	1948	3646	4508	4905	30.0	16.8										
		3	1478	2843	5322	6579	7159	47.8	27.5										
240	11	1	811	1127	2174	2715	2967	26.0	14.8	3.2	STRW 065 100 11 XXX DDD								
		2	889	1235	2382	2975	3250	30.0	16.6										
		3	1185	1646	3175	3965	4331	47.2	28.0										
	16	1	980	1488	2871	3586	3917	26.0	16.4	4.8	STRW 065 100 16 XXX DDD								
		2	1016	1543	2975	3716	3250	30.0	17.7										
		3	1489	2262	4364	5450	5954	48.1	29.7										
	21	1	1069	2056	3848	4758	5177	26.0	16.4	6.4	STRW 065 100 21 XXX DDD								
		2	1108	2130	3988	4931	5365	30.0	17.7										
		3	1624	3124	5849	7231	7868	48.1	29.7										
260	11	1	878	1220	2353	2939	3211	26.0	16.2	3.5	STRW 065 120 11 XXX DDD								
		2	969	1346	2596	3241	3541	30.0	18.6										
		3	1292	1794	3461	4322	4722	47.8	31.4										
	16	1	989	1488	2871	3586	3917	26.0	16.4	5.1	STRW 065 120 16 XXX DDD								
		2	1025	1543	2975	3716	3250	30.0	17.7										
		3	1503	2401	4632	5785	6320	48.1	29.7										
	21	1	1080	2131	3990	4933	5367	26.0	16.4	6.9	STRW 065 120 21 XXX DDD								
		2	1119	2209	4135	5112	5562	30.0	17.7										
		3	1641	3239	6064	7497	8157	48.1	29.7										
280	11	1	884	1286	2481	3098	3385	26.0	16.2	3.7	STRW 065 140 11 XXX DDD								
		2	977	1420	2739	3421	3737	30.0	18.6										
		3	1301	1892	3649	4557	4978	47.8	31.4										
	16	1	1156	1757	3390	4233	4625	26.0	19.3	5.5	STRW 065 140 16 XXX DDD								
		2	1182	1797	3465	4328	4728	30.0	20.4										
		3	1758	2670	5150	6431	7026	48.9	34.5										
	21	1	1262	2427	4543	5617	6112	26.0	19.3	7.4	STRW 065 140 21 XXX DDD								
		2	1290	2481	4645	5743	6249	30.0	20.4										
		3	1917	3687	6903	8534	9286	48.9	34.5										

Afmetingen gemeten volgens EN 16430  
 \*Geluidsmeting volgens ISO 3741:2010, op 2 m van het  
 toestel en met een aangenomen ruimtedemping van  
 8 dB(A) / inhoud lokaal 100 m<sup>3</sup> / nagalmtijd 0.5 sec.

kleurcode invullen  
 code sturing invullen

# STRADA HYBRID

# HOOGTE 095

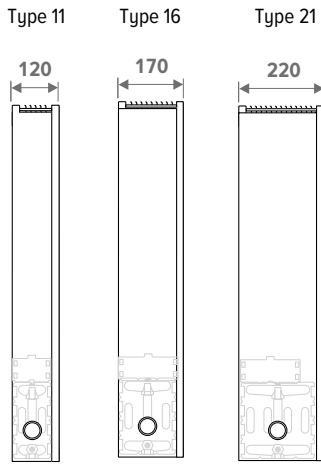

HOOGTE H cm	LENGTE L cm	TYPE T	STAND	KOELLEN (niet condensierend) Kamertemperatuur 27°C					GELUIDSDRUKNIVEAU		GEWICHT kg	WATERINHOUD L	BESTELCODE
				16/18 Watt	35/30 Watt	45/40 Watt	50/45 Watt	55/45 Watt	dB(A)	ENERGIEVERBRUIK Watt			
STRW 095	060	11	1	148	246	474	592	647	26.0	4.8	0.8	STRW 065 060 11 XXX DDD	
			2	159	263	508	634	693	30.0	5.4			
			3	188	311	601	750	820	40.0	6.8			
	16	11	1	166	301	581	726	793	26.0	4.8	1.2	STRW 065 060 16 XXX DDD	
			2	178	323	624	779	851	30.0	5.5			
			3	236	428	826	1031	1126	41.1	7.2			
	21	11	1	181	416	779	963	1048	26.0	4.8	1.6	STRW 065 060 21 XXX DDD	
			2	195	447	836	1034	1125	30.0	5.5			
			3	257	591	1106	1368	1488	41.1	7.2			
	070	11	11	1	181	301	580	724	791	26.0	5.5	0.9	STRW 065 070 11 XXX DDD
				2	194	322	622	777	849	30.0	5.9		
				3	233	385	743	928	1014	41.0	7.9		
		16	11	1	170	350	676	844	922	26.0	5.1	1.4	STRW 065 070 16 XXX DDD
				2	183	376	725	906	990	30.0	5.6		
				3	242	498	960	1199	1310	41.1	7.2		
		21	11	1	186	456	854	1056	1149	26.0	5.1	1.9	STRW 065 070 21 XXX DDD
				2	200	490	917	1134	1234	30.0	5.6		
				3	265	648	1214	1501	1633	41.1	7.2		
080	11	11	1	214	355	684	854	933	26.0	6.3	1.1	STRW 065 080 11 XXX DDD	
			2	229	381	735	917	1002	30.0	6.8			
			3	277	460	887	1107	1210	41.8	9.1			
	16	11	1	242	439	847	1058	1156	26.0	6.0	1.6	STRW 065 080 16 XXX DDD	
			2	260	471	908	1134	1239	30.0	6.7			
			3	349	632	1219	1522	1663	42.4	9.0			
	21	11	1	264	456	854	1056	1149	26.0	6.0	2.1	STRW 065 080 21 XXX DDD	
			2	283	490	917	1134	1234	30.0	6.7			
			3	380	873	1634	2020	2197	42.4	9.0			
090	11	11	1	246	355	684	854	933	26.0	6.7	1.2	STRW 065 090 11 XXX DDD	
			2	264	381	735	917	1002	30.0	7.4			
			3	322	534	1029	1286	1405	42.4	10.3			
	16	11	1	277	503	970	1211	1323	26.0	7.0	1.8	STRW 065 090 16 XXX DDD	
			2	297	539	1039	1298	1418	30.0	7.7			
			3	405	734	1415	1767	1931	43.3	10.7			
	21	11	1	303	694	1300	1607	1749	26.0	7.0	2.4	STRW 065 090 21 XXX DDD	
			2	324	744	1393	1722	1874	30.0	7.7			
			3	441	1013	1897	2345	2552	43.3	10.7			
100	11	11	1	277	460	887	1107	1210	26.0	7.8	1.3	STRW 065 100 11 XXX DDD	
			2	298	495	955	1193	1303	30.0	8.7			
			3	367	608	1173	1465	1600	43.0	12.2			
	16	11	1	312	566	1092	1364	1490	26.0	7.0	2.0	STRW 065 100 16 XXX DDD	
			2	334	606	1169	1460	1595	30.0	7.7			
			3	461	836	1612	2013	2199	44.1	10.7			
	21	11	1	341	782	1464	1809	1969	26.0	7.0	2.7	STRW 065 100 21 XXX DDD	
			2	365	837	1567	1937	2108	30.0	7.7			
			3	503	1154	2160	2671	2906	44.1	10.7			
110	11	11	1	311	516	995	1242	1357	26.0	8.4	1.5	STRW 065 110 11 XXX DDD	
			2	335	556	1072	1339	1462	30.0	9.3			
			3	411	682	1315	1643	1795	43.5	14.0			
	16	11	1	316	613	1183	1477	1614	26.0	7.9	2.2	STRW 065 110 16 XXX DDD	
			2	338	657	1267	1582	1728	30.0	8.8			
			3	467	905	1746	2181	2383	44.1	12.5			
	21	11	1	345	821	1536	1899	2067	26.0	7.9	2.9	STRW 065 110 21 XXX DDD	
			2	370	879	1645	2034	2213	30.0	8.8			
			3	510	1211	2268	2804	3051	44.1	12.5			
120	11	11	1	339	562	1084	1354	1479	26.0	8.9	1.6	STRW 065 120 11 XXX DDD	
			2	367	607	1171	1463	1598	30.0	9.9			
			3	456	756	1459	1822	1990	44.0	14.8			
	16	11	1	384	698	1346	1681	1836	26.0	8.7	2.4	STRW 065 120 16 XXX DDD	
			2	412	747	1441	1800	1966	30.0	9.8			
			3	574	1039	2005	2504	2735	44.8	14.3			
	21	11	1	420	963	1804	2230	2426	26.0	8.7	3.2	STRW 065 120 21 XXX DDD	
			2	449	1032	1932	2388	2598	30.0	9.8			
			3	625	1435	2687	3322	3615	44.8	14.3			
140	11	11	1	399	662	1277	1595	1743	26.0	10.1	1.6	STRW 065 120 11 XXX DDD	
			2	432	717	1383	1728	1887	30.0	11.2			
			3	546	905	1745	2179	2380	44.8	17.5			
	16	11	1	456	827	1596	1993	2177	26.0	9.6	2.4	STRW 065 120 16 XXX DDD	
			2	488	886	1709	2134	2332	30.0	10.5			
			3	686	1243	2398	2995	3272	45.4	16.1			
	21	11	1	498	1143	2139	2645	2877	26.0	9.6	3.2	STRW 065 120 21 XXX DDD	
			2	533	1224	2291	2832	3082	30.0	10.5			
			3	748	1717	3214	3974	4324	45.4	16.1			

Afgiftes gemeten volgens EN 16430  
 \*Geluidsmeting volgens ISO 3741:2010, op 2 m van het  
 toestel en met een aangenomen ruimtedemping van  
 8 dB(A) / inhoud lokaal 100 m<sup>3</sup> / nagalmtijd 0.5 sec.

kleurcode invullen |  
 code sturing invullen |

# STRADA HYBRID

# ONDERDELEN

## BEKLEDING



### STANDAARD LEVERING:

- rooster
- voorpaneel
- 2 zijkanten
- achterlat
- afdekplaatjes
- kleur 133, 001 of 145

### BESTELCODE

CSTW 020 050 11 XXX  
Kleur  
Type  
Lengte  
Hoogte

## VERWARMINGSSET



### STANDAARD LEVERING:

- warmtewisselaar
- wandconsole
- haakse ontluchter 1/8" (HOOGTE 020) of verlengde ontluchter 1/8"
- bevestigingsset
- aftapstop 1/2"

### BESTELCODE

HSTW 020 050 11  
Type  
Lengte  
Hoogte

## ROOSTER



### STANDAARD LEVERING:

- kleur 133, 001 of 145

### BESTELCODE

5621 000 050 11 XXX  
Kleur  
Type  
Lengte

## ACHTERLAT

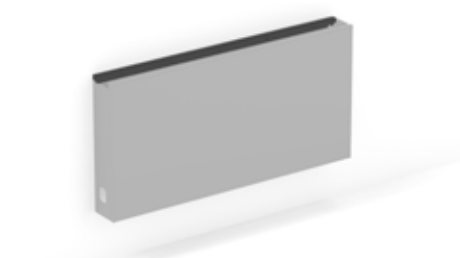

### STANDAARD LEVERING:

- kleur 133, 001 of 145

### BESTELCODE

5521 000 050 00 XXX  
Kleur  
Lengte

## VOORPANEEL

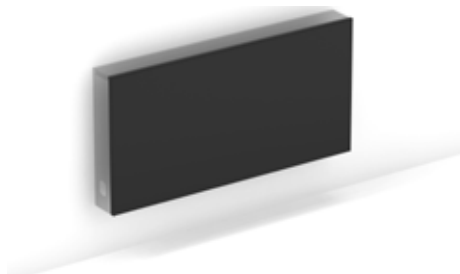

### STANDAARD LEVERING:

- kleur 133, 001 of 145

### BESTELCODE

5503 020 050 00 XXX  
Kleur  
Lengte  
Hoogte

## ZIJKANTEN (per paar)



### STANDAARD LEVERING:

- kleur 133, 001 of 145

### BESTELCODE

5721 020 000 11 XXX  
Kleur  
Type  
Hoogte

# STRADA HYBRID

# ONDERDELEN

AFDEKPLAATJE (zilver)



BESTELCODE

22165 000 400 11

AFDEKPLAATJE (wit)



BESTELCODE

22165 000 400 12

BEVESTIGINGSSET VOOR ACHTERLAT (per paar)



BESTELCODE

5521 011

CONSOLES (per stuk)



Aantal consoles voor warmtewisselaar

- van lengte 050 tot 120 cm: 2 stuks
- van lengte 140 tot 220 cm: 3 stuks
- van lengte 240 tot 280 cm: 4 stuks

BESTELCODE

5121 020 000 11

Type warmtewisselaar  
Hoogte

WARMTEWISSELAAR



STANDAARD LEVERING:

- warmtewisselaar
- incl. haakse ontluchter en aftapstop

BESTELCODE

5003 000 050 11

Type warmtewisselaar  
Lengte

Overzicht type warmtewisselaars

Strada Hybrid Type 10    Strada Hybrid Type 11    Strada Hybrid Type 15    Strada Hybrid Type 16    Strada Hybrid Type 20    Strada Hybrid Type 21

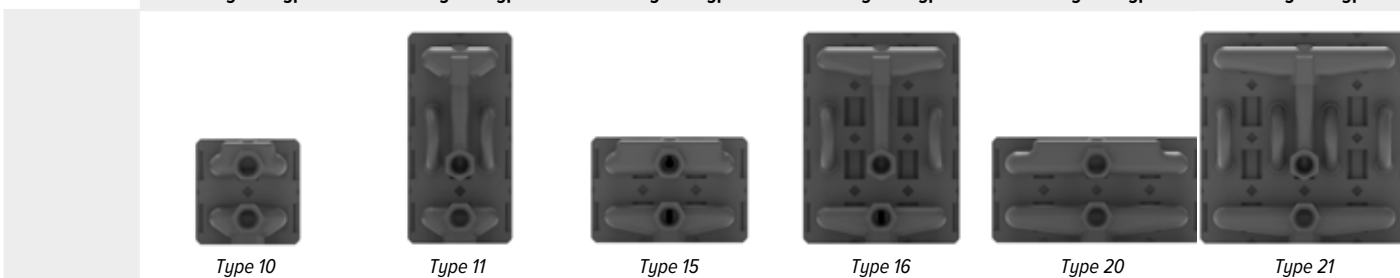

VERLENGDE ONTLUCHTER 1/8"



Bestelcode	H35						H50						H65						H95						
	Type	10	11	15	16	20	21	10	11	15	16	20	21	10	11	15	16	20	21	10	11	15	16	20	21
50900 114 078	-	✓	-	✓	-	✓	-	-	-	-	-	-	-	-	-	-	-	-	-	-	-	-	-	-	-
50900 114 178	✓	-	✓	-	✓	-	-	-	-	-	-	-	-	-	-	-	-	-	-	-	-	-	-	-	-
50900 114 278	-	-	-	-	-	-	✓	-	✓	-	✓	-	-	-	-	-	-	-	-	-	-	-	-	-	-
50900 114 378	-	-	-	-	-	-	✓	-	✓	-	✓	-	-	✓	-	✓	-	✓	-	-	-	-	-	-	-
50900 114 528	-	-	-	-	-	-	-	-	-	-	-	-	✓	-	✓	-	✓	-	-	-	-	-	-	-	-
50900 114 728	-	-	-	-	-	-	-	-	-	-	-	-	-	-	-	-	-	-	✓	✓	✓	✓	✓	✓	✓

# STRADA HYBRID

# ONDERDELEN

## DBH UPGRADE SET



### STANDAARD LEVERING:

- ventilator-unit(s)
- stuurprint met microcontroller en bediening
- netadapter 230 V/ 24VDC

### BESTELCODE

DBHS 060 10 DDD EU

Sturing: D01: Jaga TPT  
D03: Jaga BMS  
D09: Jaga ACO  
DBH Upgrade set  
Lengte

Welke type ventilator-unit is geschikt voor een type warmtewisselaar?

	Strada Hybrid Type 10	Strada Hybrid Type 11	Strada Hybrid Type 15	Strada Hybrid Type 16	Strada Hybrid Type 20	Strada Hybrid Type 21
DBH unit 10						
DBH unit 15						

De opgegeven vermogens bij  $\Delta T$  50 zijn exacte waarden, gemeten volgens EN442. Voor alle andere  $\Delta T$  geeft deze tabel een berekende waarde aan de hand van een gemiddelde correctiefactor geldig voor alle afmetingen..

Op [www.jaga.com/selection-tools/](http://www.jaga.com/selection-tools/) kunt u berekeningstools downloaden met de exacte afgiftes. De online berekeningstools worden steeds up to date gehouden met de meest recente gegevens. Minieme afgifteverschillen tussen reeds gedrukte tabellen en de verschillende online berekeningstools zijn daarom volstrekt normaal en vallen binnen de door de norm vastgelegde tolerantie marges.

## GEMIDDELDE CORRECTIEFACTOREN HYBRID PRODUCTEN - 75/65/20°C

Kamertemperatuur: 20°C

Gemiddelde N-waarde: 1.10

	TR	65	60	55	50	45	40	35	30	25
TA										
75	1.00	0.94	0.88	0.81	0.74	0.67	0.59	0.50	0.38	
70	0.95	0.89	0.83	0.77	0.70	0.63	0.55	0.47	0.36	
65		0.84	0.78	0.72	0.66	0.59	0.52	0.43	0.33	
60			0.73	0.67	0.61	0.55	0.48	0.40	0.30	
55				0.62	0.57	0.51	0.44	0.37	0.28	
50					0.52	0.46	0.40	0.33	0.25	
45						0.42	0.36	0.29	0.22	
40							0.31	0.26	0.19	
35								0.22	0.15	
30									0.12	

Kamertemperatuur: 24°C

Gemiddelde N-waarde: 1.10

	TR	65	60	55	50	45	40	35	30	25
TA										
75	0.91	0.85	0.79	0.72	0.65	0.58	0.49	0.39	0.22	
70	0.86	0.80	0.74	0.68	0.61	0.54	0.46	0.36	0.20	
65		0.75	0.69	0.63	0.57	0.50	0.42	0.33	0.19	
60			0.64	0.59	0.53	0.46	0.39	0.30	0.17	
55				0.54	0.48	0.42	0.35	0.27	0.15	
50					0.44	0.38	0.32	0.24	0.13	
45						0.33	0.28	0.21	0.11	
40							0.23	0.17	0.09	
35								0.14	0.07	
30									0.04	

## RICHTLIJN VOOR HET BEPERKEN VAN STROMINGSGELUIDEN

Buis	Buiten Ø mm	Wand- dikte mm	Max. watersnelheid (EN10255) m/s	waterinhoud per meter l	max. waterdebiet kg/u	Maximaal vermogen bij $\Delta T$ (°C) (T aanvoer - T retour)						
						$\Delta T$ 30	$\Delta T$ 20	$\Delta T$ 10	$\Delta T$ 5	$\Delta T$ 4	$\Delta T$ 3	$\Delta T$ 2
						Watt	Watt	Watt	Watt	Watt	Watt	Watt
<b>GALVA BUIS DIN 2440</b>												
3/8 DN10 OD	17.2	2.35	0.40	0.12	173	6028	4019	2009	1005	804	603	402
1/2 DN15 OD	21.3	2.65	0.40	0.20	288	10046	6698	3349	1674	1340	1005	670
3/4 DN20 OD	26.9	2.65	0.42	0.37	559	19515	13010	6505	3253	2602	1952	1301
1 DN25 OD	33.7	3.25	0.49	0.58	1023	35690	23793	11897	5948	4759	3569	2379
1 1/4 DN32 OD	42.4	3.25	0.60	1.01	2182	76101	50734	25367	12684	10147	7610	5073
1 1/2 DN40 OD	48.3	3.25	0.66	1.37	3255	113549	75700	37850	18925	15140	11355	7570
2 DN50 OD	60.3	3.65	0.80	2.21	6365	222025	148017	74008	37004	29603	22203	14802
<b>DUNWANDIG METAAL</b>												
10/1	10	1.00	0.40	0.05	72	2512	1674	837	419	335	251	167
12/1	12	1.00	0.40	0.08	115	4019	2679	1340	670	536	402	268
14/1	14	1.00	0.40	0.11	158	5526	3684	1842	921	737	553	368
15/1	15	1.00	0.40	0.13	187	6530	4353	2177	1088	871	653	435
16/1	16	1.00	0.40	0.15	216	7535	5023	2512	1256	1005	753	502
18/1	18	1.00	0.40	0.20	288	10046	6698	3349	1674	1340	1005	670
22/1	22	1.00	0.40	0.31	446	15572	10381	5191	2595	2076	1557	1038
28/1	28	1.00	0.47	0.53	904	31522	21014	10507	5254	4203	3152	2101
<b>VPE/ALU</b>												
12/2	12	2.00	0.40	0.05	72	2512	1674	837	419	335	251	167
14/2	14	2.00	0.40	0.08	115	4019	2679	1340	670	536	402	268
16/1.5	16	1.50	0.40	0.13	187	6530	4353	2177	1088	871	653	435
16/2	16	2.00	0.40	0.11	158	5526	3684	1842	921	737	553	368
17/2	17	2.00	0.40	0.13	187	6530	4353	2177	1088	871	653	435
18/2	18	2.00	0.40	0.15	216	7535	5023	2512	1256	1005	753	502
20/2	20	2.00	0.40	0.20	288	10046	6698	3349	1674	1340	1005	670
26/3	26	3.00	0.40	0.31	446	15572	10381	5191	2595	2076	1557	1038
32/3	32	3.00	0.47	0.53	904	31522	21014	10507	5254	4203	3152	2101
40/3.5	40	3.50	0.56	0.86	1726	60220	40147	20073	10037	8029	6022	4015
50/4.25	50	4.25	0.66	1.35	3206	111824	74549	37275	18637	14910	11182	7455
63/5	63	5.00	0.80	2.21	6346	221359	147573	73786	36893	29515	22136	14757



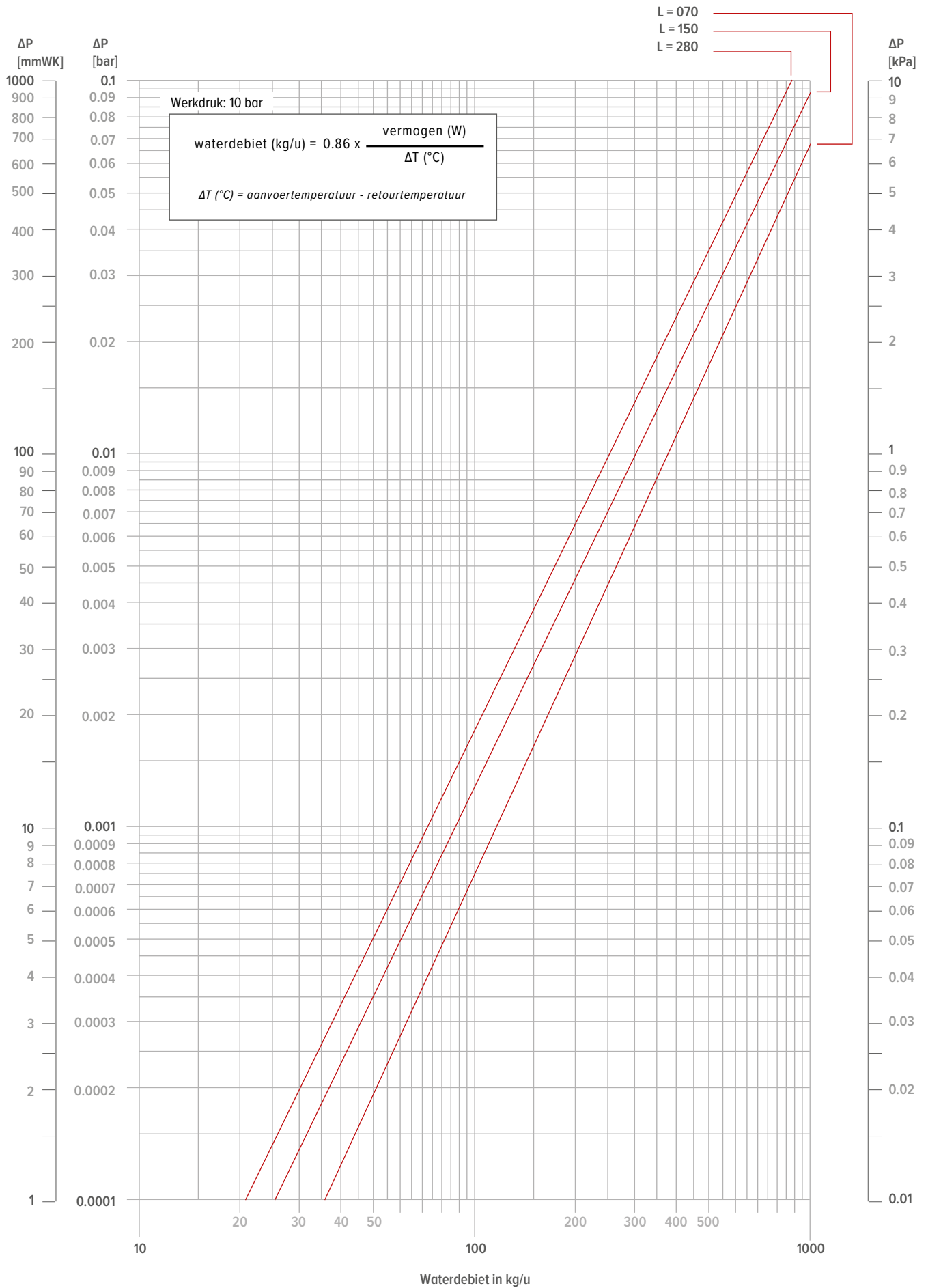

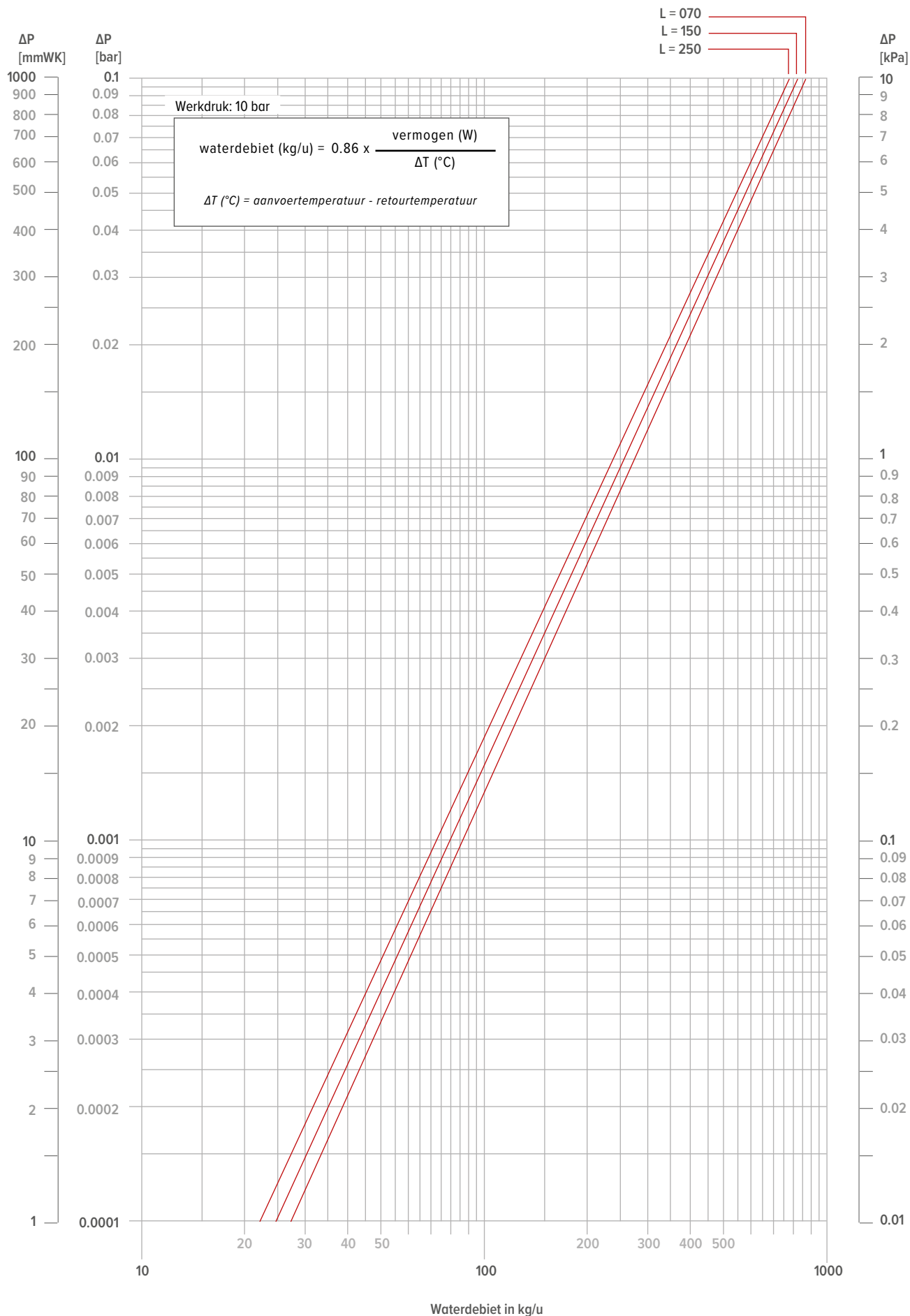

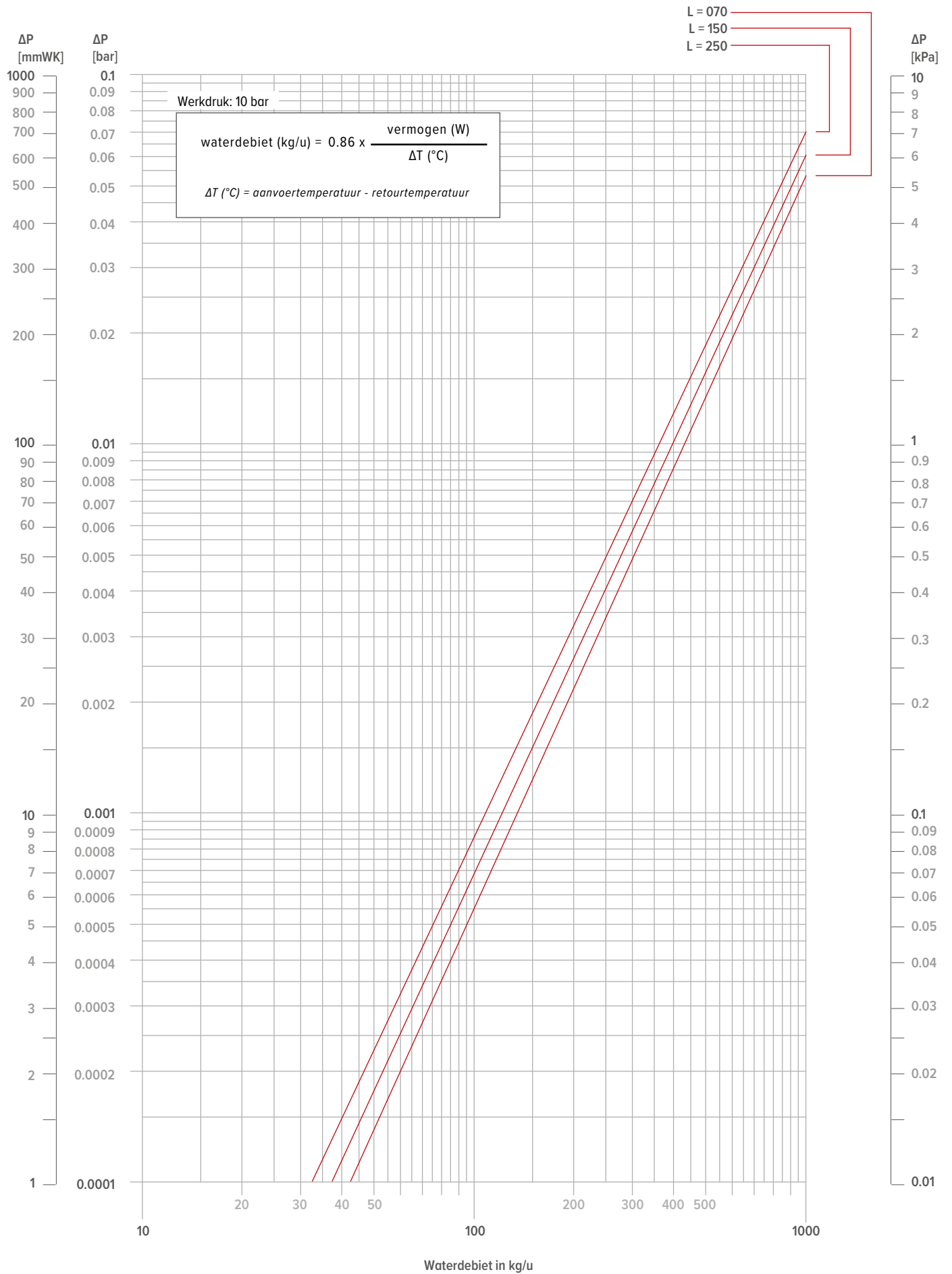



**jaga** CLIMATE  
DESIGNERS

**BELGIË JAGA NV**

Nood aan advies? Maak een afspraak in het Jaga Advies Centrum!

Verbindingslaan 16  
3590 Diepenbeek

+32 (0) 11 29 41 11

info@jaga.be  
jaga.com