

**jaga**  
CLIMATE DESIGNERS



## MINI WAND





# MINI

|   |           |
|---|-----------|
| <b>INHOUDSOPGAVE</b>  | <b>3</b>  |
| <b>TECHNISCHE INFORMATIE</b>  | <b>5</b>  |
| <b>Afmetingen</b>   | <b>5</b>  |
| <b>Standaard levering</b>   | <b>5</b>  |
| <b>Kleuren</b>  | <b>5</b>  |
| <b>Waterzijdige aansluiting</b>   | <b>6</b>  |
| Hoogte 008 Standaard: aanvoer links of rechts                                       | 6         |
| Hoogte 013 - 023 - 028 Standaard: Aansluiting links of rechts met bediening beneden | 6         |
| Hoogte 013 - 023 - 028 afstandsbediend  | 6         |
| <b>Meest gebruikte aansluitsets</b>   | <b>7</b>  |
| Hoogte 008  | 7         |
| Hoogte 013- 023 - 028   | 7         |
| <b>Technische tabel</b>   | <b>8</b>  |
| Hoogte 020  | 8         |
| Hoogte 013  | 9         |
| Hoogte 023  | 10        |
| Hoogte 028  | 11        |
| <b>Onderdelen</b>   | <b>12</b> |
| <b>Correctiefactoren</b>  | <b>13</b> |
| <b>Drukverliezen</b>  | <b>14</b> |
| Type 05   | 14        |
| Type 06   | 15        |
| Type 09 dubbelzijdig  | 16        |
| Type 10   | 17        |
| Type 11   | 18        |
| Type 14 dubbelzijdig  | 19        |
| Type 15   | 20        |
| Type 16   | 21        |
| Type 19 dubbelzijdig  | 22        |
| Type 20   | 23        |
| Type 21   | 24        |



# MINI

AFMETINGEN (in mm)

HOOGTE 008 (dubbelzijdige aansluiting)

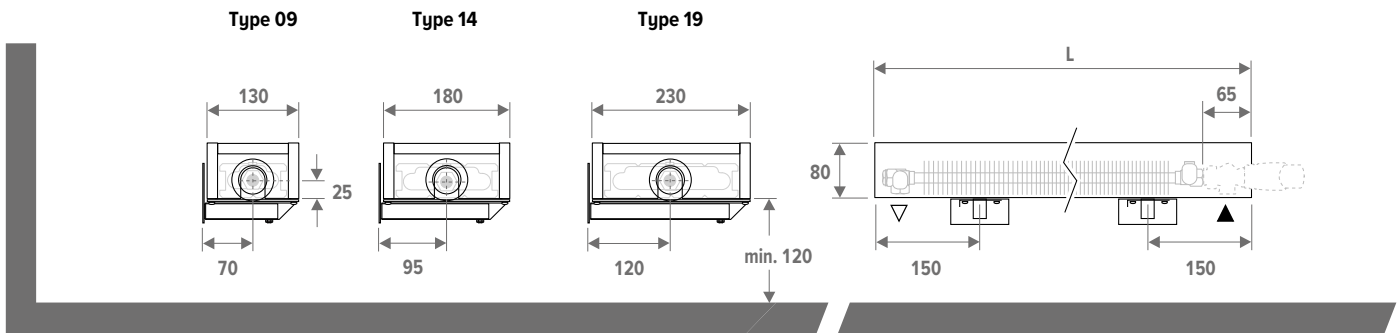

HOOGTE 013

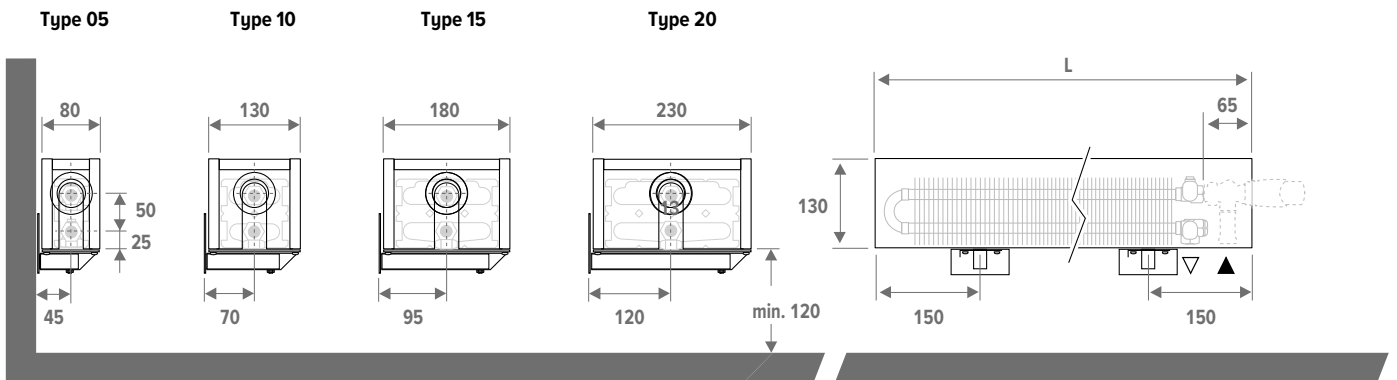

HOOGTE 023 / 028

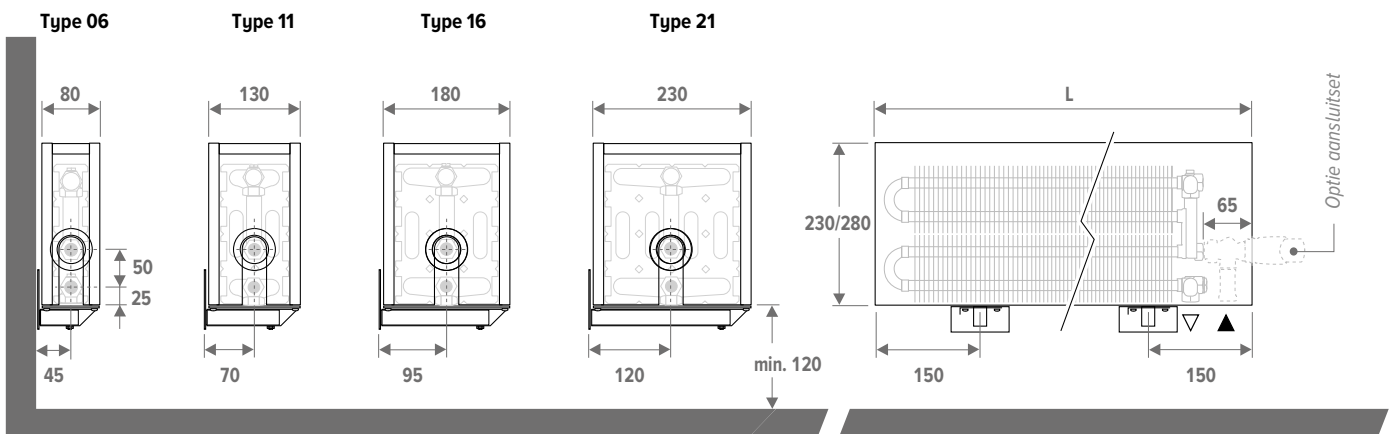

## STANDAARD LEVERING

- Low-H<sub>2</sub>O warmtewisselaar, met vuilafstotende en stofwerende laklaag in grafietgrijs (RAL 7024)
- wandconsoles, bevestigingsset, ontlufter 1/8" en aftapstop 1/2"
- bekleding uit één stuk voor aansluiting links of rechts
- wandbevestigingen in de kleur van de bekleding

## KLEUREN

Milieuvriendelijk gelakt met krasvaste poedercoating met hoge UV-bestendigheid

### Standaard kleuren

- verkeerswit RAL 9016 (133), soft touch licht gestructureerde satijn lak
- zandstraalgrijs (001), fine texture metallic lak
- off-black (145), soft touch licht gestructureerde satijn lak

### Andere kleuren

Zie Jaga kleurenkaart.

Meerprijs afhankelijk van de lengte van het toestel:

- Lengte < 100 cm
- Lengte van 100 cm tot 200 cm
- Lengte > 200 cm

## BESTELCODE

MINW 008 060 10 XXX

— Kleur  
 — Type  
 — Lengte  
 — Hoogte

## MINI HOOGTE 008

## WATERZIJDIGE AANSLUITING

### STANDAARD: DUBBELZIJDIGE AANSLUITING, AANVOER LINKS OF RECHTS

Links of rechts beneden, naar de wand of naar de vloer. Wandaansluiting via onderzijde bekleding. Aansluiting naar de wand binnen de bekleding is niet mogelijk vanwege de dichte achterwand. De installateur kan de warmtewisselaar draaien voor een rechtse of linkse aansluiting.

Aansluiting naar de wand: set 225 of 285 en 1 bocht

Aansluiting naar de vloer: set 222 of 282

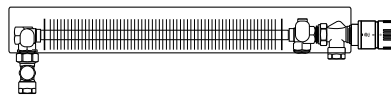
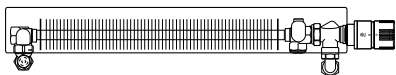

## MINI HOOGTE 013 - 023 - 028

## WATERZIJDIGE AANSLUITING

### STANDAARD: AANSLUITING LINKS OF RECHTS MET BEDIENING BENEDEN

Links of rechts beneden, naar de wand of naar de vloer. Wandaansluiting via onderzijde bekleding. Aansluiting naar de wand binnen de bekleding is niet mogelijk vanwege de dichte achterwand.

Mogelijke Euroconus aansluitsets: 101, 102, 103, 104, 181, 182, 183, 184, 222, 225, 226, 282, 285

Mogelijke M24 aansluitsets: 11, 12, 13, 14

#### Voorbeeld aansluiting rechts (standaard)

#### Voorbeeld aansluiting links

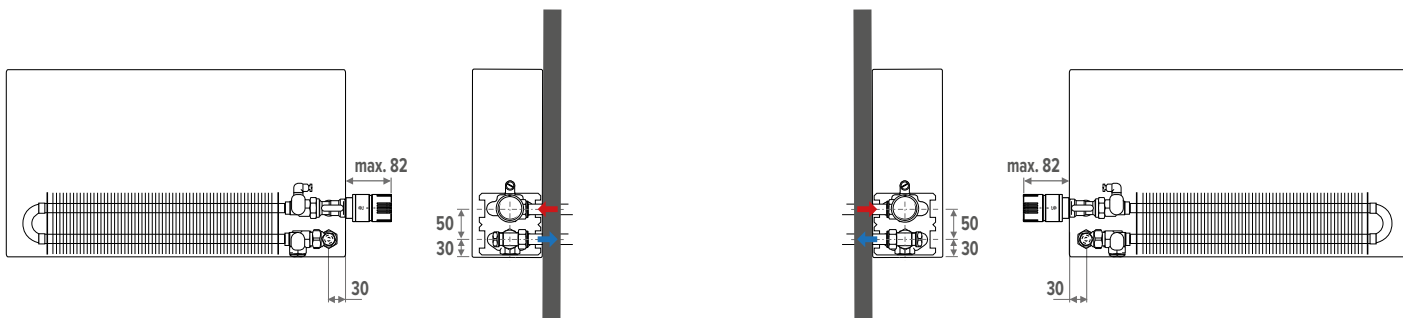

### AANSLUITING LINKS OF RECHTS MET BEDIENING OP AFSTAND

De code van de radiator aanvullen met **00** (dichte zijanten). Vb. MINW.013 060 05 xxx **00**

Mogelijke Euroconus aansluitsets: 111, 112, 113, 114

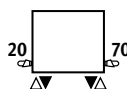

#### Voorbeeld aansluiting rechts (standaard)

#### Voorbeeld aansluiting links

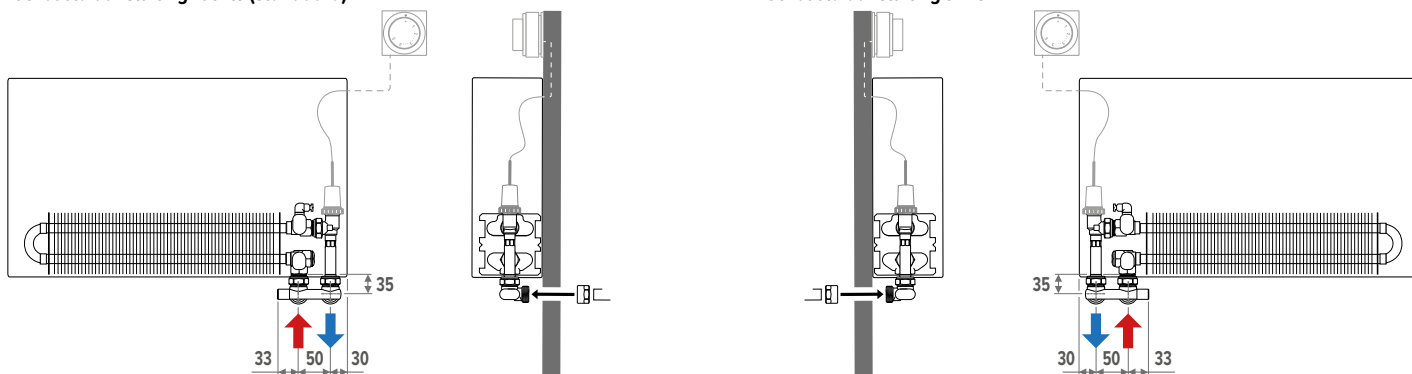

## MINI HOOGTE 008

### NAAR DE WAND

Met Jaga ventiel



set **KVS: 0.8**  
**225** TWEEPIJP

|                  |    |  |
|------------------|----|--|
| COLO SW2 AC 4... | AC |  |
| COLO SW2 AW 4... | AW |  |
| COLO SW2 AS 4... | AS |  |
| COLO SW2 AB 4... | AB |  |
| COLO SW2 JH 4... | JH |  |

code klemkoppeling invullen

Met Gampper Vario DP  
Dynamisch ventiel



set automatische debietregeling (20 - 340 l/u)  
**285** TWEEPIJP

|                  |    |  |
|------------------|----|--|
| COLO GW2 AC 4... | AC |  |
| COLO GW2 AW 4... | AW |  |
| COLO GW2 AS 4... | AS |  |
| COLO GW2 AB 4... | AB |  |
| COLO.GW2.JH.4... | JH |  |

code klemkoppeling invullen

### NAAR DE VLOER

Met Jaga ventiel



set **KVS: 0.8**  
**222** TWEEPIJP

|                  |    |  |
|------------------|----|--|
| COLO JF2 AC 4... | AC |  |
| COLO JF2 AW 4... | AW |  |
| COLO JF2 AS 4... | AS |  |
| COLO JF2 AB 4... | AB |  |
| COLO JF2 JH 4... | JH |  |

code klemkoppeling invullen

Met Gampper Vario DP  
Dynamisch ventiel



set automatische debietregeling (20 - 340 l/u)  
**282** TWEEPIJP

|                  |    |  |
|------------------|----|--|
| COLO GF2 AC 4... | AC |  |
| COLO GF2 AW 4... | AW |  |
| COLO GF2 AS 4... | AS |  |
| COLO GF2 AB 4... | AB |  |
| COLO GF2 JH 4... | JH |  |

code klemkoppeling invullen

### Bocht



5095 4020

Uitgebreide informatie van de ventielen,  
zie brochure "Aansluitsets & ventielen"

### Klemkoppelingen 3/4" Euroconus

| DUNWANDIG METAAL |        | KUNSTSTOF OF VPE/ALU |        |
|------------------|--------|----------------------|--------|
| CODE             | Buis Ø | CODE                 | Buis Ø |
| 112              | 12/1   | 612                  | 12/2   |
| 114              | 14/1   | 614                  | 14/2   |
| 115              | 15/1   | 616                  | 16/2   |
| 116              | 16/1   | 618                  | 18/2   |
| 118              | 18/1   | 619                  | 16/1.5 |
|                  |        | 620                  | 20/2   |

## MINI HOOGTE 013- 023 - 028

### NAAR DE WAND - AANVOER BUITENZIJD

Met Jaga H-ventiel



set **KVS: 0.8**  
**103** TWEEPIJP / EENPIJP

|                   |    |  |
|-------------------|----|--|
| COLO HBSW AC 4... | AC |  |
| COLO HBSW AW 4... | AW |  |
| COLO HBSW AS 4... | AS |  |
| COLO HBSW AB 4... | AB |  |
| COLO HBSW JH 4... | JH |  |

code klemkoppeling invullen

Met Gampper Vario DP  
Dynamisch ventiel



set automatische debietregeling (20 - 340 l/u)  
**183** TWEEPIJP

|                   |    |  |
|-------------------|----|--|
| COLO GASW AC 4... | AC |  |
| COLO GASW AW 4... | AW |  |
| COLO GASW AS 4... | AS |  |
| COLO GASW AB 4... | AB |  |
| COLO GASW JH 4... | JH |  |

code klemkoppeling invullen

### NAAR DE VLOER - AANVOER BUITENZIJD

Met Jaga H-ventiel



set **KVS: 0.8**  
**104** TWEEPIJP / EENPIJP

|                   |    |  |
|-------------------|----|--|
| COLO HBSF AC 4... | AC |  |
| COLO HBSF AW 4... | AW |  |
| COLO HBSF AS 4... | AS |  |
| COLO HBSF AB 4... | AB |  |
| COLO HBSF JH 4... | JH |  |

code klemkoppeling invullen

Met Gampper Vario DP  
Dynamisch ventiel

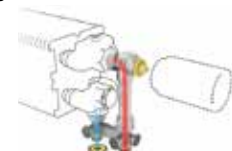

set automatische debietregeling (20 - 340 l/u)  
**184** TWEEPIJP

|                   |    |  |
|-------------------|----|--|
| COLO GASF AC 4... | AC |  |
| COLO GASF AW 4... | AW |  |
| COLO GASF AS 4... | AS |  |
| COLO GASF AB 4... | AB |  |
| COLO GASF JH 4... | JH |  |

code klemkoppeling invullen

### NAAR DE WAND - AANVOER BINNENZIJD

Met Jaga Crossflow ventiel



set **KVS: 0.8**  
**101** TWEEPIJP

|                   |    |  |
|-------------------|----|--|
| COLO HBCW AC 4... | AC |  |
| COLO HBCW AW 4... | AW |  |
| COLO HBCW AS 4... | AS |  |
| COLO HBCW AB 4... | AB |  |
| COLO HBCW JH 4... | JH |  |

code klemkoppeling invullen

Met Gampper Vario DP  
Dynamisch ventiel



set automatische debietregeling (20 - 340 l/u)  
**181** TWEEPIJP

|                   |    |  |
|-------------------|----|--|
| COLO GACW AC 4... | AC |  |
| COLO GACW AW 4... | AW |  |
| COLO GACW AS 4... | AS |  |
| COLO GACW AB 4... | AB |  |
| COLO GACW JH 4... | JH |  |

code klemkoppeling invullen

### NAAR DE VLOER - AANVOER BINNENZIJD

Met Jaga Crossflow ventiel

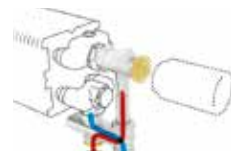

set **KVS: 0.8**  
**102** TWEEPIJP

|                   |    |  |
|-------------------|----|--|
| COLO HBCF AC 4... | AC |  |
| COLO HBCF AW 4... | AW |  |
| COLO HBCF AS 4... | AS |  |
| COLO HBCF AB 4... | AB |  |
| COLO HBCF JH 4... | JH |  |

code klemkoppeling invullen

Met Gampper Vario DP  
Dynamisch ventiel

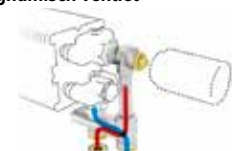

set automatische debietregeling (20 - 340 l/u)  
**182** TWEEPIJP

|                   |    |  |
|-------------------|----|--|
| COLO GACF AC 4... | AC |  |
| COLO GACF AW 4... | AW |  |
| COLO GACF AS 4... | AS |  |
| COLO GACF AB 4... | AB |  |
| COLO GACF JH 4... | JH |  |

code klemkoppeling invullen

# MINI WAND HOOGTE 008 (STANDAARD)

# TECHNISCHE TABEL

Type 09



Type 14



Type 19



| HOOGTE<br>H<br>cm | LENGTE<br>L<br>cm | TYPE<br>T | VERWARMEN<br>kamer temperatuur 20°C |               |               |                 |                 | BESTELCODE |
|-------------------|-------------------|-----------|-------------------------------------|---------------|---------------|-----------------|-----------------|------------|
|                   |                   |           | 35/30<br>Watt                       | 45/40<br>Watt | 50/45<br>Watt | 55/45<br>Watt   | 75/65<br>Watt   |            |
| MINW 008 060      | ---               | ---       | ---                                 | ---           | ---           | ---             | ---             |            |
|                   | 09                | 35        | 82                                  | 109           | 123           | 255             | MINW 008 060 09 |            |
|                   | 14                | 57        | 134                                 | 178           | 200           | 416             | MINW 008 060 14 |            |
| 19                | 79                | 184       | 245                                 | 275           | 572           | MINW 008 060 19 |                 |            |
| 070               | ---               | ---       | ---                                 | ---           | ---           | ---             | ---             |            |
|                   | 09                | 41        | 96                                  | 128           | 143           | 298             | MINW 008 070 09 |            |
|                   | 14                | 67        | 156                                 | 208           | 234           | 486             | MINW 008 070 14 |            |
| 19                | 92                | 215       | 286                                 | 321           | 667           | MINW 008 070 19 |                 |            |
| 080               | ---               | ---       | ---                                 | ---           | ---           | ---             | ---             |            |
|                   | 09                | 47        | 109                                 | 146           | 163           | 340             | MINW 008 080 09 |            |
|                   | 14                | 77        | 179                                 | 238           | 267           | 555             | MINW 008 080 14 |            |
| 19                | 105               | 245       | 327                                 | 366           | 762           | MINW 008 080 19 |                 |            |
| 090               | ---               | ---       | ---                                 | ---           | ---           | ---             | ---             |            |
|                   | 09                | 53        | 123                                 | 164           | 184           | 383             | MINW 008 090 09 |            |
|                   | 14                | 86        | 201                                 | 268           | 300           | 625             | MINW 008 090 14 |            |
| 19                | 118               | 276       | 368                                 | 412           | 858           | MINW 008 090 19 |                 |            |
| 100               | ---               | ---       | ---                                 | ---           | ---           | ---             | ---             |            |
|                   | 09                | 59        | 137                                 | 182           | 204           | 425             | MINW 008 100 09 |            |
|                   | 14                | 96        | 223                                 | 298           | 333           | 694             | MINW 008 100 14 |            |
| 19                | 132               | 307       | 409                                 | 458           | 953           | MINW 008 100 19 |                 |            |
| 110               | ---               | ---       | ---                                 | ---           | ---           | ---             | ---             |            |
|                   | 09                | 65        | 151                                 | 201           | 225           | 468             | MINW 008 110 09 |            |
|                   | 14                | 105       | 246                                 | 327           | 367           | 763             | MINW 008 110 14 |            |
| 19                | 145               | 337       | 449                                 | 504           | 1048          | MINW 008 110 19 |                 |            |
| 120               | ---               | ---       | ---                                 | ---           | ---           | ---             | ---             |            |
|                   | 09                | 70        | 164                                 | 219           | 245           | 510             | MINW 008 120 09 |            |
|                   | 14                | 115       | 268                                 | 357           | 400           | 833             | MINW 008 120 14 |            |
| 19                | 158               | 368       | 490                                 | 550           | 1144          | MINW 008 120 19 |                 |            |
| 140               | ---               | ---       | ---                                 | ---           | ---           | ---             | ---             |            |
|                   | 09                | 82        | 192                                 | 255           | 286           | 595             | MINW 008 140 09 |            |
|                   | 14                | 134       | 313                                 | 417           | 467           | 972             | MINW 008 140 14 |            |
| 19                | 184               | 429       | 572                                 | 641           | 1334          | MINW 008 140 19 |                 |            |
| 160               | ---               | ---       | ---                                 | ---           | ---           | ---             | ---             |            |
|                   | 09                | 94        | 219                                 | 292           | 327           | 680             | MINW 008 160 09 |            |
|                   | 14                | 153       | 357                                 | 476           | 533           | 1110            | MINW 008 160 14 |            |
| 19                | 211               | 491       | 654                                 | 733           | 1525          | MINW 008 160 19 |                 |            |
| 180               | ---               | ---       | ---                                 | ---           | ---           | ---             | ---             |            |
|                   | 09                | 106       | 246                                 | 328           | 368           | 765             | MINW 008 180 09 |            |
|                   | 14                | 172       | 402                                 | 535           | 600           | 1249            | MINW 008 180 14 |            |
| 19                | 237               | 552       | 735                                 | 824           | 1715          | MINW 008 180 19 |                 |            |
| 200               | ---               | ---       | ---                                 | ---           | ---           | ---             | ---             |            |
|                   | 09                | 117       | 274                                 | 364           | 408           | 850             | MINW 008 200 09 |            |
|                   | 14                | 192       | 447                                 | 595           | 667           | 1388            | MINW 008 200 14 |            |
| 19                | 263               | 614       | 817                                 | 916           | 1906          | MINW 008 200 19 |                 |            |
| 220               | ---               | ---       | ---                                 | ---           | ---           | ---             | ---             |            |
|                   | 09                | 129       | 301                                 | 401           | 449           | 935             | MINW 008 220 09 |            |
|                   | 14                | 211       | 492                                 | 655           | 734           | 1527            | MINW 008 220 14 |            |
| 19                | 289               | 675       | 899                                 | 1008          | 2097          | MINW 008 220 19 |                 |            |
| 240               | ---               | ---       | ---                                 | ---           | ---           | ---             | ---             |            |
|                   | 09                | 141       | 328                                 | 437           | 490           | 1020            | MINW 008 240 09 |            |
|                   | 14                | 230       | 536                                 | 714           | 801           | 1666            | MINW 008 240 14 |            |
| 19                | 316               | 736       | 981                                 | 1099          | 2287          | MINW 008 240 19 |                 |            |
| 260               | ---               | ---       | ---                                 | ---           | ---           | ---             | ---             |            |
|                   | 09                | 153       | 356                                 | 474           | 531           | 1105            | MINW 008 260 09 |            |
|                   | 14                | 249       | 581                                 | 773           | 867           | 1804            | MINW 008 260 14 |            |
| 19                | 342               | 798       | 1062                                | 1191          | 2478          | MINW 008 260 19 |                 |            |
| 280               | ---               | ---       | ---                                 | ---           | ---           | ---             | ---             |            |
|                   | 09                | 164       | 383                                 | 510           | 572           | 1190            | MINW 008 280 09 |            |
|                   | 14                | 268       | 626                                 | 833           | 934           | 1943            | MINW 008 280 14 |            |
| 19                | 368               | 859       | 1144                                | 1282          | 2668          | MINW 008 280 19 |                 |            |
| 300               | ---               | ---       | ---                                 | ---           | ---           | ---             | ---             |            |
|                   | 09                | 176       | 410                                 | 547           | 613           | 1275            | MINW 008 300 09 |            |
|                   | 14                | 287       | 670                                 | 893           | 1000          | 2082            | MINW 008 300 14 |            |
| 19                | 395               | 920       | 1226                                | 1374          | 2859          | MINW 008 300 19 |                 |            |



# MINI WAND HOOGTE 013 (TWIN)

# TECHNISCHE TABEL

Type 05



Type 10

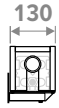

Type 15

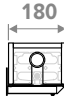

Type 20

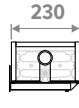

| HOOGTE<br>H<br>cm | LENGTE<br>L<br>cm | TYPE<br>T | VERWARMEN<br>kamertemperatuur 20°C |               |               |               |               | BESTELCODE      |
|-------------------|-------------------|-----------|------------------------------------|---------------|---------------|---------------|---------------|-----------------|
|                   |                   |           | 35/30<br>Watt                      | 45/40<br>Watt | 50/45<br>Watt | 55/45<br>Watt | 75/65<br>Watt |                 |
| MINW 013 060      | 05                | 05        | 27                                 | 64            | 85            | 95            | 197           | MINW 013 060 05 |
|                   | 10                | 10        | 42                                 | 97            | 130           | 146           | 303           | MINW 013 060 10 |
|                   | 15                | 15        | 70                                 | 164           | 218           | 244           | 508           | MINW 013 060 15 |
|                   | 20                | 20        | 99                                 | 231           | 308           | 345           | 717           | MINW 013 060 20 |
| 070               | 05                | 05        | 32                                 | 74            | 99            | 111           | 230           | MINW 013 070 05 |
|                   | 10                | 10        | 49                                 | 114           | 152           | 170           | 354           | MINW 013 070 10 |
|                   | 15                | 15        | 82                                 | 191           | 255           | 285           | 593           | MINW 013 070 15 |
|                   | 20                | 20        | 116                                | 270           | 359           | 403           | 837           | MINW 013 070 20 |
| 080               | 05                | 05        | 37                                 | 85            | 113           | 127           | 263           | MINW 013 080 05 |
|                   | 10                | 10        | 56                                 | 130           | 173           | 194           | 404           | MINW 013 080 10 |
|                   | 15                | 15        | 94                                 | 219           | 291           | 326           | 678           | MINW 013 080 15 |
|                   | 20                | 20        | 132                                | 308           | 410           | 460           | 956           | MINW 013 080 20 |
| 090               | 05                | 05        | 41                                 | 96            | 127           | 143           | 296           | MINW 013 090 05 |
|                   | 10                | 10        | 63                                 | 146           | 195           | 219           | 455           | MINW 013 090 10 |
|                   | 15                | 15        | 105                                | 246           | 327           | 367           | 762           | MINW 013 090 15 |
|                   | 20                | 20        | 149                                | 347           | 462           | 518           | 1076          | MINW 013 090 20 |
| 100               | 05                | 05        | 46                                 | 106           | 141           | 158           | 329           | MINW 013 100 05 |
|                   | 10                | 10        | 70                                 | 162           | 216           | 243           | 505           | MINW 013 100 10 |
|                   | 15                | 15        | 117                                | 273           | 364           | 407           | 847           | MINW 013 100 15 |
|                   | 20                | 20        | 165                                | 385           | 513           | 575           | 1195          | MINW 013 100 20 |
| 110               | 05                | 05        | 50                                 | 117           | 156           | 174           | 362           | MINW 013 110 05 |
|                   | 10                | 10        | 77                                 | 179           | 238           | 267           | 556           | MINW 013 110 10 |
|                   | 15                | 15        | 129                                | 301           | 400           | 448           | 932           | MINW 013 110 15 |
|                   | 20                | 20        | 182                                | 424           | 564           | 633           | 1315          | MINW 013 110 20 |
| 120               | 05                | 05        | 55                                 | 128           | 170           | 190           | 395           | MINW 013 120 05 |
|                   | 10                | 10        | 84                                 | 195           | 260           | 291           | 606           | MINW 013 120 10 |
|                   | 15                | 15        | 141                                | 328           | 436           | 489           | 1016          | MINW 013 120 15 |
|                   | 20                | 20        | 198                                | 462           | 616           | 690           | 1434          | MINW 013 120 20 |
| 140               | 05                | 05        | 64                                 | 149           | 198           | 222           | 461           | MINW 013 140 05 |
|                   | 10                | 10        | 97                                 | 227           | 303           | 340           | 707           | MINW 013 140 10 |
|                   | 15                | 15        | 164                                | 382           | 509           | 570           | 1186          | MINW 013 140 15 |
|                   | 20                | 20        | 232                                | 539           | 718           | 805           | 1673          | MINW 013 140 20 |
| 160               | 05                | 05        | 73                                 | 170           | 226           | 253           | 526           | MINW 013 160 05 |
|                   | 10                | 10        | 111                                | 260           | 346           | 388           | 808           | MINW 013 160 10 |
|                   | 15                | 15        | 188                                | 437           | 582           | 652           | 1355          | MINW 013 160 15 |
|                   | 20                | 20        | 265                                | 617           | 821           | 920           | 1912          | MINW 013 160 20 |
| 180               | 05                | 05        | 82                                 | 191           | 255           | 285           | 592           | MINW 013 180 05 |
|                   | 10                | 10        | 125                                | 292           | 389           | 437           | 909           | MINW 013 180 10 |
|                   | 15                | 15        | 211                                | 492           | 655           | 734           | 1525          | MINW 013 180 15 |
|                   | 20                | 20        | 298                                | 694           | 923           | 1035          | 2151          | MINW 013 180 20 |
| 200               | 05                | 05        | 91                                 | 213           | 283           | 317           | 658           | MINW 013 200 05 |
|                   | 10                | 10        | 139                                | 325           | 433           | 485           | 1010          | MINW 013 200 10 |
|                   | 15                | 15        | 234                                | 546           | 727           | 815           | 1694          | MINW 013 200 15 |
|                   | 20                | 20        | 331                                | 771           | 1026          | 1150          | 2390          | MINW 013 200 20 |
| 220               | 05                | 05        | 101                                | 234           | 311           | 349           | 724           | MINW 013 220 05 |
|                   | 10                | 10        | 153                                | 357           | 476           | 534           | 1111          | MINW 013 220 10 |
|                   | 15                | 15        | 258                                | 601           | 800           | 896           | 1863          | MINW 013 220 15 |
|                   | 20                | 20        | 364                                | 848           | 1129          | 1265          | 2629          | MINW 013 220 20 |
| 240               | 05                | 05        | 110                                | 255           | 340           | 381           | 790           | MINW 013 240 05 |
|                   | 10                | 10        | 167                                | 390           | 519           | 582           | 1212          | MINW 013 240 10 |
|                   | 15                | 15        | 281                                | 656           | 873           | 978           | 2033          | MINW 013 240 15 |
|                   | 20                | 20        | 397                                | 925           | 1231          | 1380          | 2868          | MINW 013 240 20 |
| 260               | 05                | 05        | 119                                | 276           | 368           | 412           | 855           | MINW 013 260 05 |
|                   | 10                | 10        | 181                                | 422           | 563           | 631           | 1313          | MINW 013 260 10 |
|                   | 15                | 15        | 305                                | 710           | 945           | 1059          | 2202          | MINW 013 260 15 |
|                   | 20                | 20        | 430                                | 1002          | 1334          | 1495          | 3107          | MINW 013 260 20 |
| 280               | 05                | 05        | 128                                | 298           | 396           | 444           | 921           | MINW 013 280 05 |
|                   | 10                | 10        | 195                                | 455           | 606           | 679           | 1414          | MINW 013 280 10 |
|                   | 15                | 15        | 328                                | 765           | 1018          | 1141          | 2372          | MINW 013 280 15 |
|                   | 20                | 20        | 463                                | 1079          | 1436          | 1609          | 3346          | MINW 013 280 20 |
| 300               | 05                | 05        | 137                                | 319           | 424           | 475           | 987           | MINW 013 300 05 |
|                   | 10                | 10        | 209                                | 487           | 649           | 728           | 1515          | MINW 013 300 10 |
|                   | 15                | 15        | 352                                | 819           | 1091          | 1222          | 2541          | MINW 013 300 15 |
|                   | 20                | 20        | 496                                | 1156          | 1539          | 1724          | 3585          | MINW 013 300 20 |

# MINI WAND HOOGTE 023 (TWIN)

# TECHNISCHE TABEL

Type 06



Type 11

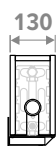

Type 16

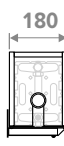

Type 21

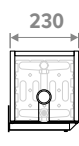

| HOOGTE<br>H<br>cm | LENGTE<br>L<br>cm | TYPE<br>T | VERWARMEN<br>Kamertemperatuur 20°C |               |               |               |               | BESTELCODE      |
|-------------------|-------------------|-----------|------------------------------------|---------------|---------------|---------------|---------------|-----------------|
|                   |                   |           | 35/30<br>Watt                      | 45/40<br>Watt | 50/45<br>Watt | 55/45<br>Watt | 75/65<br>Watt |                 |
| MINW 023 060      | 06                | 06        | 45                                 | 105           | 139           | 156           | 323           | MINW 023 060 06 |
|                   | 11                | 11        | 80                                 | 190           | 254           | 285           | 601           | MINW 023 060 11 |
|                   | 16                | 16        | 103                                | 246           | 330           | 370           | 785           | MINW 023 060 16 |
|                   | 21                | 21        | 132                                | 317           | 426           | 479           | 1021          | MINW 023 060 21 |
| 070               | 06                | 06        | 53                                 | 122           | 162           | 182           | 377           | MINW 023 070 06 |
|                   | 11                | 11        | 94                                 | 222           | 296           | 333           | 701           | MINW 023 070 11 |
|                   | 16                | 16        | 120                                | 287           | 385           | 432           | 916           | MINW 023 070 16 |
|                   | 21                | 21        | 154                                | 370           | 497           | 559           | 1191          | MINW 023 070 21 |
| 080               | 06                | 06        | 60                                 | 140           | 186           | 208           | 431           | MINW 023 080 06 |
|                   | 11                | 11        | 107                                | 253           | 339           | 381           | 802           | MINW 023 080 11 |
|                   | 16                | 16        | 137                                | 327           | 439           | 494           | 1046          | MINW 023 080 16 |
|                   | 21                | 21        | 176                                | 423           | 568           | 639           | 1361          | MINW 023 080 21 |
| 090               | 06                | 06        | 68                                 | 157           | 209           | 234           | 485           | MINW 023 090 06 |
|                   | 11                | 11        | 121                                | 285           | 381           | 428           | 902           | MINW 023 090 11 |
|                   | 16                | 16        | 155                                | 368           | 494           | 555           | 1177          | MINW 023 090 16 |
|                   | 21                | 21        | 198                                | 475           | 639           | 719           | 1531          | MINW 023 090 21 |
| 100               | 06                | 06        | 75                                 | 174           | 232           | 260           | 539           | MINW 023 100 06 |
|                   | 11                | 11        | 134                                | 317           | 424           | 476           | 1002          | MINW 023 100 11 |
|                   | 16                | 16        | 172                                | 409           | 549           | 617           | 1308          | MINW 023 100 16 |
|                   | 21                | 21        | 220                                | 528           | 710           | 799           | 1701          | MINW 023 100 21 |
| 110               | 06                | 06        | 83                                 | 192           | 255           | 286           | 593           | MINW 023 110 06 |
|                   | 11                | 11        | 147                                | 348           | 466           | 523           | 1102          | MINW 023 110 11 |
|                   | 16                | 16        | 189                                | 450           | 604           | 679           | 1439          | MINW 023 110 16 |
|                   | 21                | 21        | 243                                | 581           | 781           | 878           | 1871          | MINW 023 110 21 |
| 120               | 06                | 06        | 90                                 | 209           | 279           | 312           | 647           | MINW 023 120 06 |
|                   | 11                | 11        | 161                                | 380           | 508           | 571           | 1202          | MINW 023 120 11 |
|                   | 16                | 16        | 206                                | 491           | 659           | 741           | 1570          | MINW 023 120 16 |
|                   | 21                | 21        | 265                                | 634           | 852           | 958           | 2041          | MINW 023 120 21 |
| 140               | 06                | 06        | 105                                | 244           | 325           | 364           | 755           | MINW 023 140 06 |
|                   | 11                | 11        | 188                                | 443           | 593           | 666           | 1403          | MINW 023 140 11 |
|                   | 16                | 16        | 241                                | 573           | 769           | 864           | 1831          | MINW 023 140 16 |
|                   | 21                | 21        | 309                                | 739           | 994           | 1118          | 2381          | MINW 023 140 21 |
| 160               | 06                | 06        | 120                                | 279           | 371           | 416           | 862           | MINW 023 160 06 |
|                   | 11                | 11        | 214                                | 507           | 678           | 761           | 1603          | MINW 023 160 11 |
|                   | 16                | 16        | 275                                | 655           | 879           | 988           | 2093          | MINW 023 160 16 |
|                   | 21                | 21        | 353                                | 845           | 1136          | 1278          | 2722          | MINW 023 160 21 |
| 180               | 06                | 06        | 135                                | 314           | 418           | 468           | 970           | MINW 023 180 06 |
|                   | 11                | 11        | 241                                | 570           | 763           | 857           | 1804          | MINW 023 180 11 |
|                   | 16                | 16        | 309                                | 737           | 988           | 1111          | 2354          | MINW 023 180 16 |
|                   | 21                | 21        | 397                                | 951           | 1278          | 1438          | 3062          | MINW 023 180 21 |
| 200               | 06                | 06        | 150                                | 349           | 464           | 520           | 1078          | MINW 023 200 06 |
|                   | 11                | 11        | 268                                | 633           | 847           | 952           | 2004          | MINW 023 200 11 |
|                   | 16                | 16        | 344                                | 819           | 1098          | 1234          | 2616          | MINW 023 200 16 |
|                   | 21                | 21        | 441                                | 1057          | 1420          | 1597          | 3402          | MINW 023 200 21 |
| 220               | 06                | 06        | 165                                | 384           | 511           | 572           | 1186          | MINW 023 220 06 |
|                   | 11                | 11        | 295                                | 697           | 932           | 1047          | 2204          | MINW 023 220 11 |
|                   | 16                | 16        | 378                                | 901           | 1208          | 1358          | 2878          | MINW 023 220 16 |
|                   | 21                | 21        | 485                                | 1162          | 1562          | 1757          | 3742          | MINW 023 220 21 |
| 240               | 06                | 06        | 180                                | 419           | 557           | 624           | 1294          | MINW 023 240 06 |
|                   | 11                | 11        | 321                                | 760           | 1017          | 1142          | 2405          | MINW 023 240 11 |
|                   | 16                | 16        | 413                                | 983           | 1318          | 1481          | 3139          | MINW 023 240 16 |
|                   | 21                | 21        | 529                                | 1268          | 1704          | 1916          | 4082          | MINW 023 240 21 |
| 260               | 06                | 06        | 195                                | 454           | 603           | 676           | 1401          | MINW 023 260 06 |
|                   | 11                | 11        | 348                                | 823           | 1102          | 1237          | 2605          | MINW 023 260 11 |
|                   | 16                | 16        | 447                                | 1065          | 1428          | 1605          | 3401          | MINW 023 260 16 |
|                   | 21                | 21        | 573                                | 1374          | 1846          | 2076          | 4423          | MINW 023 260 21 |
| 280               | 06                | 06        | 210                                | 489           | 650           | 728           | 1509          | MINW 023 280 06 |
|                   | 11                | 11        | 375                                | 887           | 1187          | 1332          | 2806          | MINW 023 280 11 |
|                   | 16                | 16        | 481                                | 1146          | 1538          | 1728          | 3662          | MINW 023 280 16 |
|                   | 21                | 21        | 617                                | 1479          | 1988          | 2236          | 4763          | MINW 023 280 21 |
| 300               | 06                | 06        | 225                                | 523           | 696           | 780           | 1617          | MINW 023 300 06 |
|                   | 11                | 11        | 402                                | 950           | 1271          | 1427          | 3006          | MINW 023 300 11 |
|                   | 16                | 16        | 516                                | 1228          | 1648          | 1852          | 3924          | MINW 023 300 16 |
|                   | 21                | 21        | 661                                | 1585          | 2130          | 2396          | 5103          | MINW 023 300 21 |

# MINI WAND HOOGTE 028 (TWIN)

# TECHNISCHE TABEL

Type 06

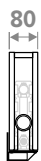

Type 11

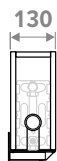

Type 16

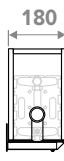

Type 21

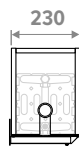

| HOOGTE<br>H  | LENGTE<br>L | TYPE<br>T | VERWARMEN<br>kamer temperatuur 20°C |               |               |               |               | BESTELCODE      |
|--------------|-------------|-----------|-------------------------------------|---------------|---------------|---------------|---------------|-----------------|
|              |             |           | 35/30<br>Watt                       | 45/40<br>Watt | 50/45<br>Watt | 55/45<br>Watt | 75/65<br>Watt |                 |
| MINW 028 060 | 06          | 06        | 48                                  | 111           | 148           | 166           | 342           | MINW 028 060 06 |
|              | 11          | 11        | 87                                  | 206           | 276           | 310           | 653           | MINW 028 060 11 |
|              | 16          | 16        | 113                                 | 269           | 361           | 405           | 860           | MINW 028 060 16 |
|              | 21          | 21        | 145                                 | 349           | 469           | 528           | 1127          | MINW 028 060 21 |
| 070          | 06          | 06        | 56                                  | 130           | 173           | 193           | 399           | MINW 028 070 06 |
|              | 11          | 11        | 102                                 | 241           | 322           | 362           | 762           | MINW 028 070 11 |
|              | 16          | 16        | 131                                 | 313           | 421           | 473           | 1003          | MINW 028 070 16 |
|              | 21          | 21        | 170                                 | 407           | 548           | 616           | 1315          | MINW 028 070 21 |
| 080          | 06          | 06        | 64                                  | 149           | 197           | 221           | 456           | MINW 028 080 06 |
|              | 11          | 11        | 116                                 | 275           | 368           | 414           | 871           | MINW 028 080 11 |
|              | 16          | 16        | 150                                 | 358           | 481           | 540           | 1146          | MINW 028 080 16 |
|              | 21          | 21        | 194                                 | 465           | 626           | 704           | 1503          | MINW 028 080 21 |
| 090          | 06          | 06        | 72                                  | 167           | 222           | 248           | 513           | MINW 028 090 06 |
|              | 11          | 11        | 131                                 | 310           | 414           | 465           | 980           | MINW 028 090 11 |
|              | 16          | 16        | 169                                 | 403           | 541           | 608           | 1290          | MINW 028 090 16 |
|              | 21          | 21        | 218                                 | 523           | 704           | 792           | 1691          | MINW 028 090 21 |
| 100          | 06          | 06        | 80                                  | 186           | 247           | 276           | 570           | MINW 028 100 06 |
|              | 11          | 11        | 146                                 | 344           | 461           | 517           | 1089          | MINW 028 100 11 |
|              | 16          | 16        | 188                                 | 448           | 601           | 676           | 1433          | MINW 028 100 16 |
|              | 21          | 21        | 242                                 | 582           | 782           | 880           | 1879          | MINW 028 100 21 |
| 110          | 06          | 06        | 88                                  | 204           | 271           | 304           | 627           | MINW 028 110 06 |
|              | 11          | 11        | 160                                 | 379           | 507           | 569           | 1198          | MINW 028 110 11 |
|              | 16          | 16        | 207                                 | 493           | 661           | 743           | 1576          | MINW 028 110 16 |
|              | 21          | 21        | 266                                 | 640           | 861           | 968           | 2067          | MINW 028 110 21 |
| 120          | 06          | 06        | 96                                  | 223           | 296           | 331           | 684           | MINW 028 120 06 |
|              | 11          | 11        | 175                                 | 413           | 553           | 621           | 1307          | MINW 028 120 11 |
|              | 16          | 16        | 225                                 | 538           | 721           | 811           | 1720          | MINW 028 120 16 |
|              | 21          | 21        | 291                                 | 698           | 939           | 1056          | 2255          | MINW 028 120 21 |
| 140          | 06          | 06        | 112                                 | 260           | 345           | 386           | 798           | MINW 028 140 06 |
|              | 11          | 11        | 204                                 | 482           | 645           | 724           | 1525          | MINW 028 140 11 |
|              | 16          | 16        | 263                                 | 627           | 841           | 946           | 2006          | MINW 028 140 16 |
|              | 21          | 21        | 339                                 | 814           | 1095          | 1233          | 2631          | MINW 028 140 21 |
| 160          | 06          | 06        | 129                                 | 297           | 395           | 442           | 912           | MINW 028 160 06 |
|              | 11          | 11        | 233                                 | 551           | 737           | 827           | 1742          | MINW 028 160 11 |
|              | 16          | 16        | 301                                 | 717           | 962           | 1081          | 2293          | MINW 028 160 16 |
|              | 21          | 21        | 387                                 | 931           | 1252          | 1408          | 3006          | MINW 028 160 21 |
| 180          | 06          | 06        | 145                                 | 334           | 444           | 497           | 1026          | MINW 028 180 06 |
|              | 11          | 11        | 262                                 | 619           | 829           | 931           | 1960          | MINW 028 180 11 |
|              | 16          | 16        | 338                                 | 806           | 1082          | 1216          | 2579          | MINW 028 180 16 |
|              | 21          | 21        | 436                                 | 1047          | 1408          | 1584          | 3382          | MINW 028 180 21 |
| 200          | 06          | 06        | 161                                 | 371           | 493           | 552           | 1140          | MINW 028 200 06 |
|              | 11          | 11        | 291                                 | 688           | 921           | 1034          | 2178          | MINW 028 200 11 |
|              | 16          | 16        | 376                                 | 896           | 1202          | 1351          | 2866          | MINW 028 200 16 |
|              | 21          | 21        | 484                                 | 1163          | 1565          | 1761          | 3758          | MINW 028 200 21 |
| 220          | 06          | 06        | 177                                 | 409           | 542           | 607           | 1254          | MINW 028 220 06 |
|              | 11          | 11        | 320                                 | 757           | 1013          | 1138          | 2396          | MINW 028 220 11 |
|              | 16          | 16        | 413                                 | 985           | 1322          | 1486          | 3153          | MINW 028 220 16 |
|              | 21          | 21        | 533                                 | 1280          | 1721          | 1937          | 4134          | MINW 028 220 21 |
| 240          | 06          | 06        | 193                                 | 446           | 592           | 662           | 1368          | MINW 028 240 06 |
|              | 11          | 11        | 349                                 | 826           | 1105          | 1241          | 2614          | MINW 028 240 11 |
|              | 16          | 16        | 451                                 | 1075          | 1442          | 1621          | 3439          | MINW 028 240 16 |
|              | 21          | 21        | 581                                 | 1396          | 1878          | 2113          | 4510          | MINW 028 240 21 |
| 260          | 06          | 06        | 209                                 | 483           | 641           | 718           | 1482          | MINW 028 260 06 |
|              | 11          | 11        | 378                                 | 895           | 1197          | 1344          | 2831          | MINW 028 260 11 |
|              | 16          | 16        | 488                                 | 1165          | 1563          | 1756          | 3726          | MINW 028 260 16 |
|              | 21          | 21        | 630                                 | 1512          | 2034          | 2289          | 4885          | MINW 028 260 21 |
| 280          | 06          | 06        | 225                                 | 520           | 690           | 773           | 1596          | MINW 028 280 06 |
|              | 11          | 11        | 408                                 | 964           | 1289          | 1448          | 3049          | MINW 028 280 11 |
|              | 16          | 16        | 526                                 | 1254          | 1683          | 1891          | 4012          | MINW 028 280 16 |
|              | 21          | 21        | 678                                 | 1629          | 2191          | 2465          | 5261          | MINW 028 280 21 |
| 300          | 06          | 06        | 241                                 | 557           | 740           | 828           | 1710          | MINW 028 300 06 |
|              | 11          | 11        | 437                                 | 1033          | 1382          | 1551          | 3267          | MINW 028 300 11 |
|              | 16          | 16        | 564                                 | 1344          | 1803          | 2027          | 4299          | MINW 028 300 16 |
|              | 21          | 21        | 727                                 | 1745          | 2347          | 2641          | 5637          | MINW 028 300 21 |

# MINI

# ONDERDELEN

## BEKLEDING

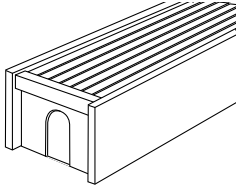

### STANDAARD LEVERING:

- voorgemonteerde bekleding
- kleur 133, 001 of 145;
- meerprijs andere kleur

### BESTELCODE

CMIN 008 060 09 XXX

| Kleur  
| Type  
| Lengte  
| Hoogte

## WANDBEVESTIGING

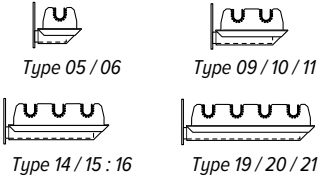

### aantal bevestigingen voor bekleding

- van 060 tot 160 cm: min. 2 stuks
- van 180 tot 300 cm: min. 3 stuks

### BESTELCODE

5205 000 000 06 XXX W

| Kleur  
| Type

## WARMTEWISSELAAR



### STANDAARD LEVERING:

- warmtewisselaar inclusief ontlufter en aftapstop

### BESTELCODE

5003 000 060 05 BS9

| Type warmtewisselaar  
| Lengte

## Overzicht type warmtewisselaars

|                          | Mini Type 05 | Mini Type 06 | Mini Type 09 | Mini Type 10 | Mini Type 11 | Mini Type 14 | Mini Type 15 | Mini Type 16 | Mini Type 19 | Mini Type 20 | Mini Type 21 |
|--------------------------|--------------|--------------|--------------|--------------|--------------|--------------|--------------|--------------|--------------|--------------|--------------|
| Hoogte 008               |              |              |              |              |              |              |              |              |              |              |              |
| Hoogte 013               |              |              |              |              |              |              |              |              |              |              |              |
| Hoogte 023<br>Hoogte 028 |              |              |              |              |              |              |              |              |              |              |              |

De opgegeven vermogens bij  $\Delta T$  50 zijn exacte waarden, gemeten volgens EN442. Voor alle andere  $\Delta T$  geeft deze tabel een berekende waarde aan de hand van een gemiddelde correctiefactor geldig voor alle afmetingen..

Op [www.jaga.com/selection-tools/](http://www.jaga.com/selection-tools/) kunt u berekeningstools downloaden met de exacte afgiftes. De online berekeningstools worden steeds up to date gehouden met de meest recente gegevens. Minieme afgifteverschillen tussen reeds gedrukte tabellen en de verschillende online berekeningstools zijn daarom volstrekt normaal en vallen binnen de door de norm vastgelegde toleranties.

#### GEMIDDELDE CORRECTIEFACTOREN STATISCHE PRODUCTEN VOLGENS EN442 - 75/65/20°C

Kamertemperatuur: 20°C

Gemiddelde N-waarde: 1.36

|    | TR | 65   | 60   | 55   | 50   | 45   | 40   | 35   | 30   | 25   |
|----|----|------|------|------|------|------|------|------|------|------|
| TA |    |      |      |      |      |      |      |      |      |      |
| 75 |    | 1.00 | 0.93 | 0.85 | 0.77 | 0.69 | 0.61 | 0.52 | 0.42 | 0.31 |
| 70 |    | 0.94 | 0.87 | 0.79 | 0.72 | 0.64 | 0.56 | 0.48 | 0.39 | 0.28 |
| 65 |    |      | 0.80 | 0.74 | 0.67 | 0.60 | 0.52 | 0.44 | 0.35 | 0.25 |
| 60 |    |      |      | 0.68 | 0.61 | 0.55 | 0.48 | 0.40 | 0.32 | 0.23 |
| 55 |    |      |      |      | 0.56 | 0.50 | 0.43 | 0.36 | 0.29 | 0.20 |
| 50 |    |      |      |      |      | 0.44 | 0.38 | 0.32 | 0.25 | 0.18 |
| 45 |    |      |      |      |      |      | 0.34 | 0.28 | 0.22 | 0.15 |
| 40 |    |      |      |      |      |      |      | 0.24 | 0.19 | 0.13 |
| 35 |    |      |      |      |      |      |      |      | 0.15 | 0.10 |
| 30 |    |      |      |      |      |      |      |      |      | 0.07 |

Kamertemperatuur: 24°C

Gemiddelde N-waarde: 1.36

|    | TR | 65   | 60   | 55   | 50   | 45   | 40   | 35   | 30   | 25   |
|----|----|------|------|------|------|------|------|------|------|------|
| TA |    |      |      |      |      |      |      |      |      |      |
| 75 |    | 0.89 | 0.82 | 0.75 | 0.67 | 0.59 | 0.51 | 0.41 | 0.31 | 0.16 |
| 70 |    | 0.83 | 0.76 | 0.69 | 0.62 | 0.54 | 0.47 | 0.38 | 0.28 | 0.14 |
| 65 |    |      | 0.70 | 0.64 | 0.57 | 0.50 | 0.43 | 0.35 | 0.25 | 0.12 |
| 60 |    |      |      | 0.58 | 0.52 | 0.45 | 0.38 | 0.31 | 0.23 | 0.11 |
| 55 |    |      |      |      | 0.47 | 0.41 | 0.34 | 0.28 | 0.20 | 0.09 |
| 50 |    |      |      |      |      | 0.36 | 0.30 | 0.24 | 0.17 | 0.08 |
| 45 |    |      |      |      |      |      | 0.26 | 0.20 | 0.14 | 0.06 |
| 40 |    |      |      |      |      |      |      | 0.17 | 0.12 | 0.05 |
| 35 |    |      |      |      |      |      |      |      | 0.09 | 0.03 |
| 30 |    |      |      |      |      |      |      |      |      | 0.02 |

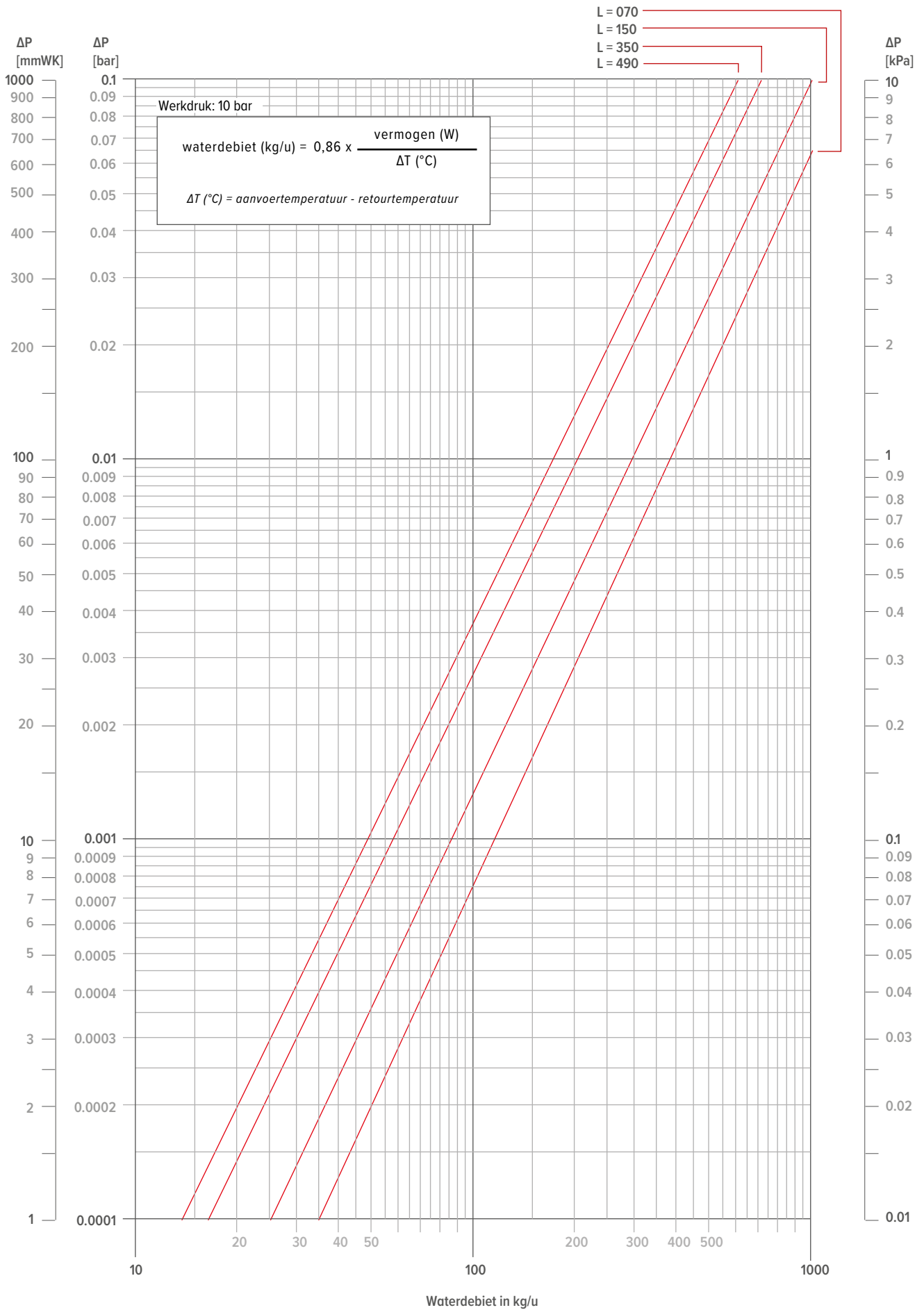

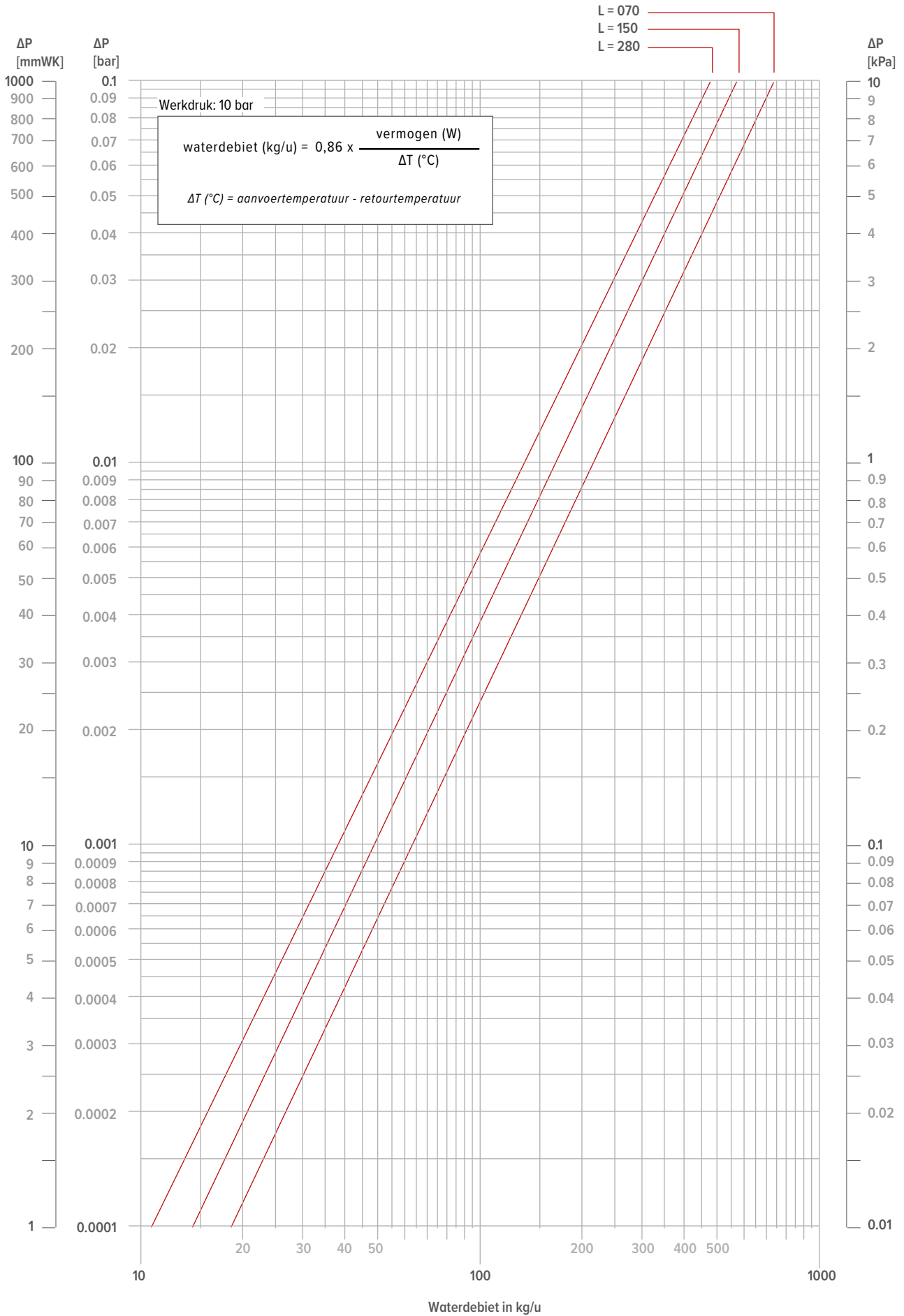

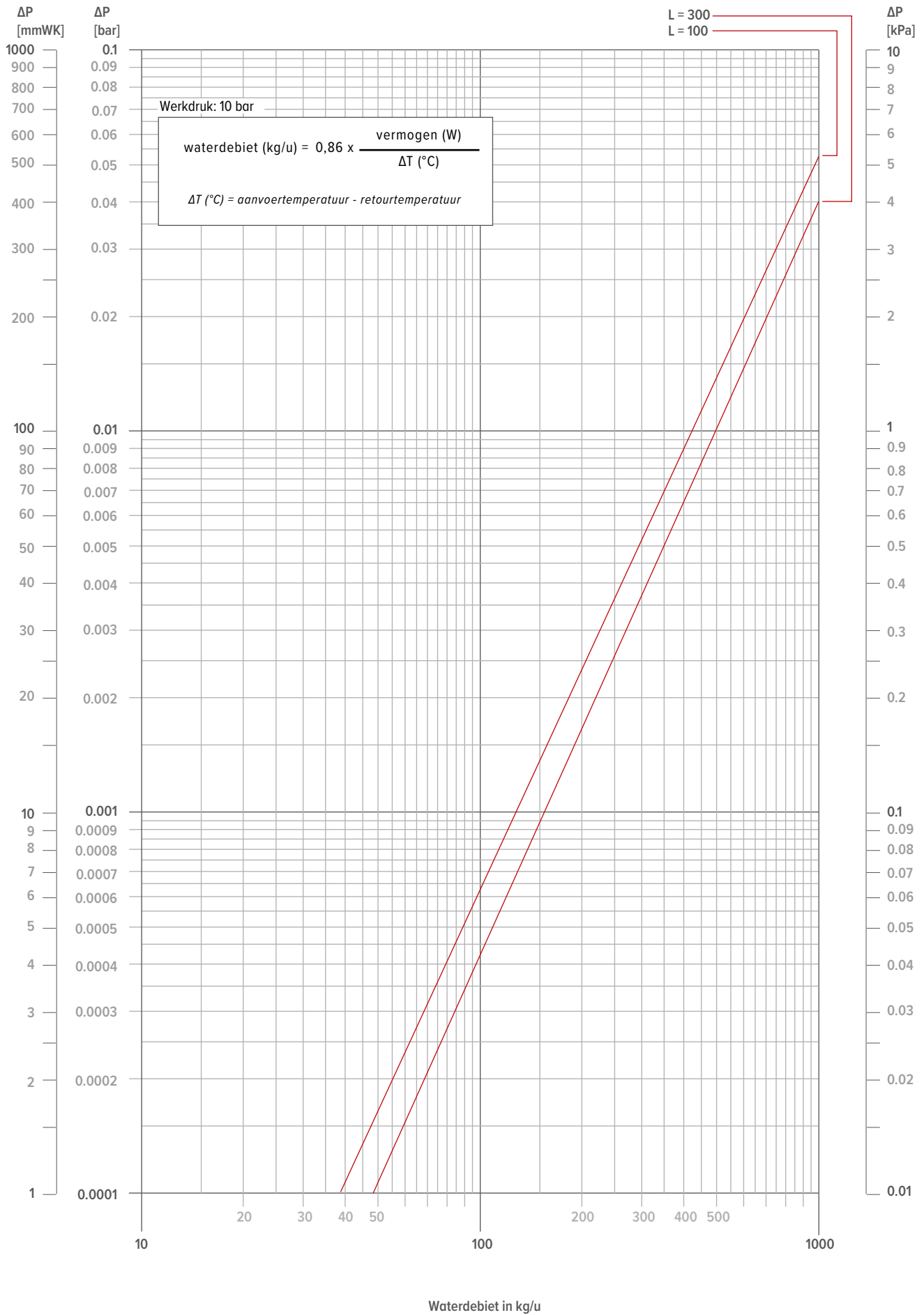



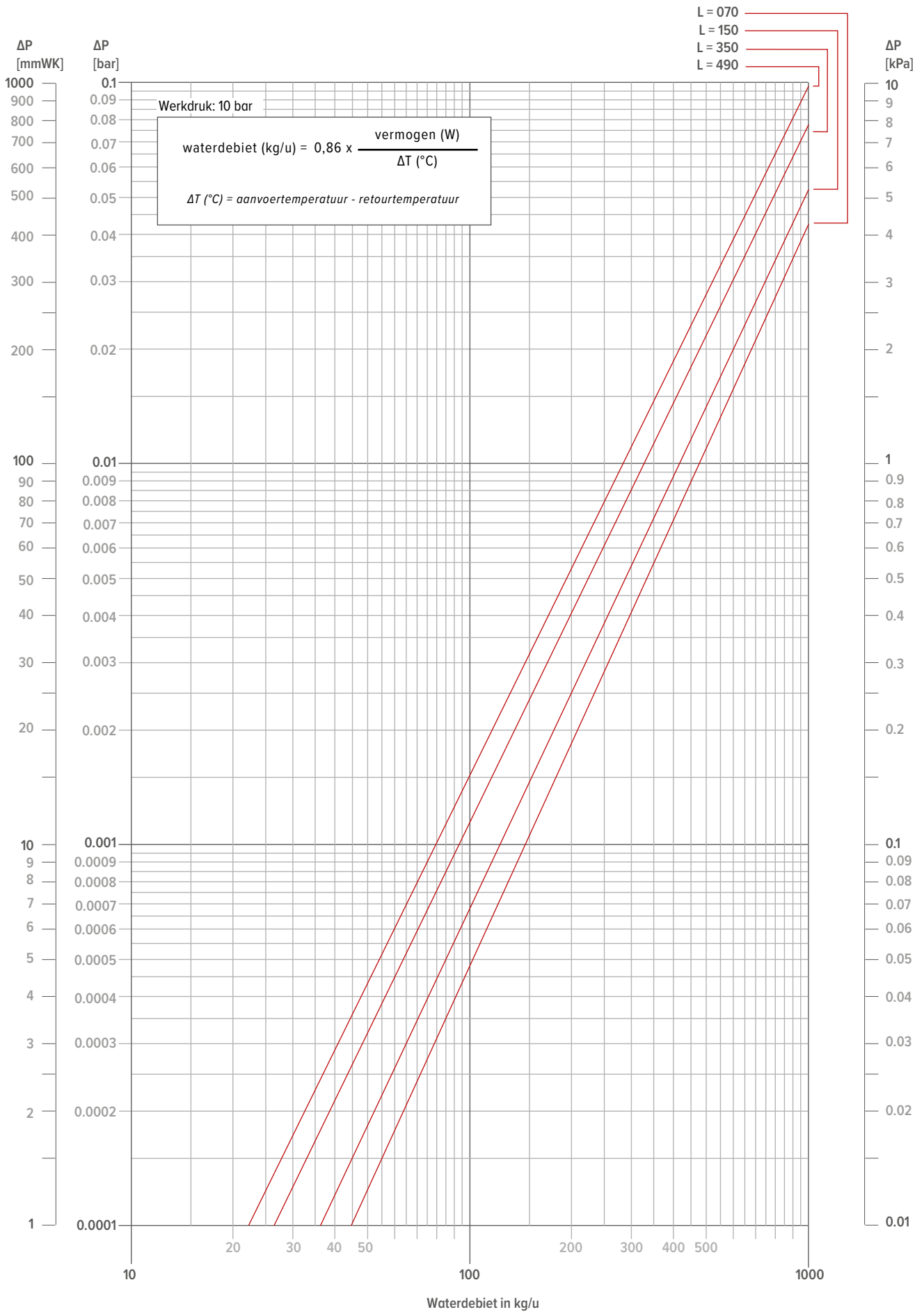

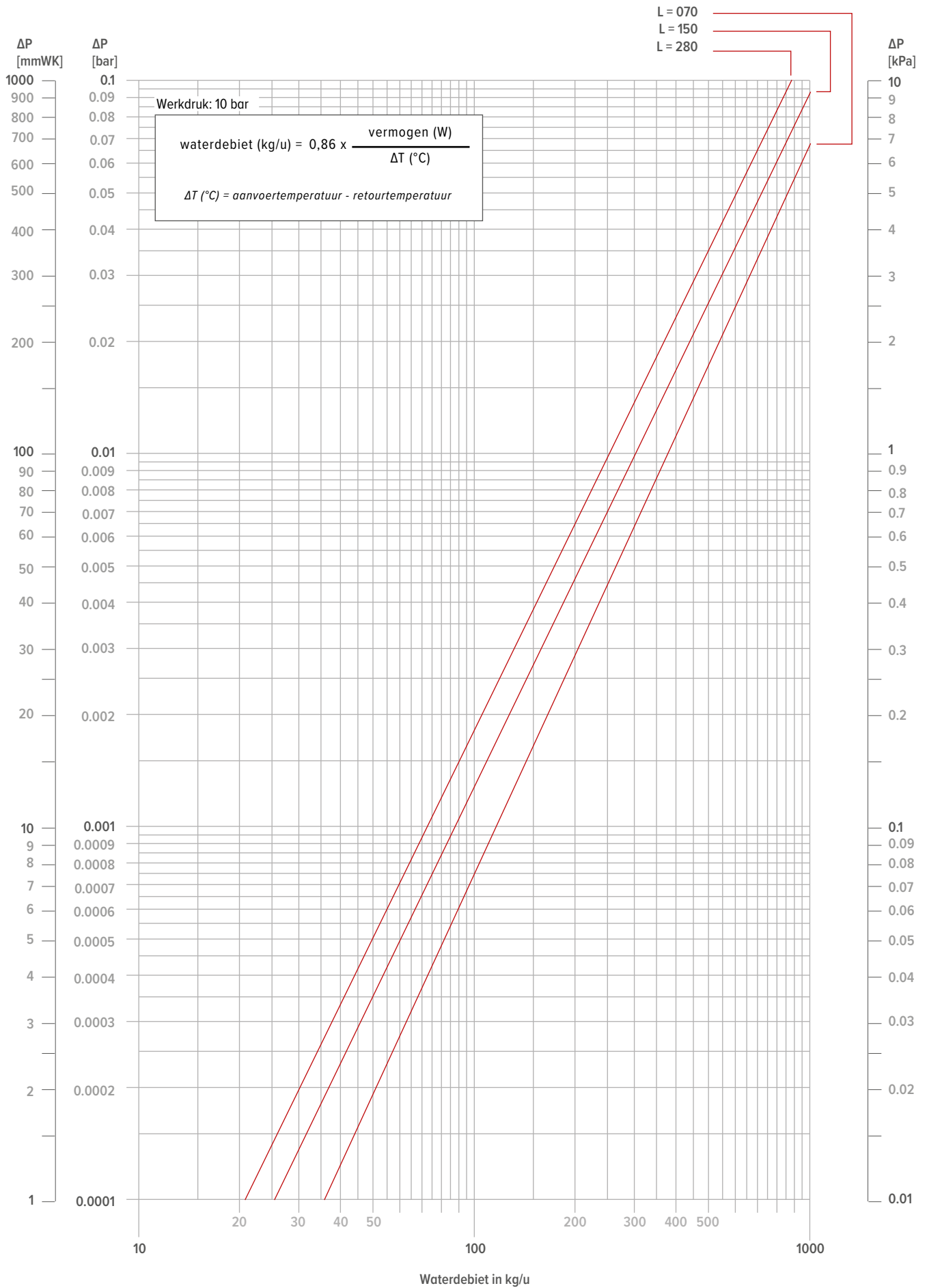

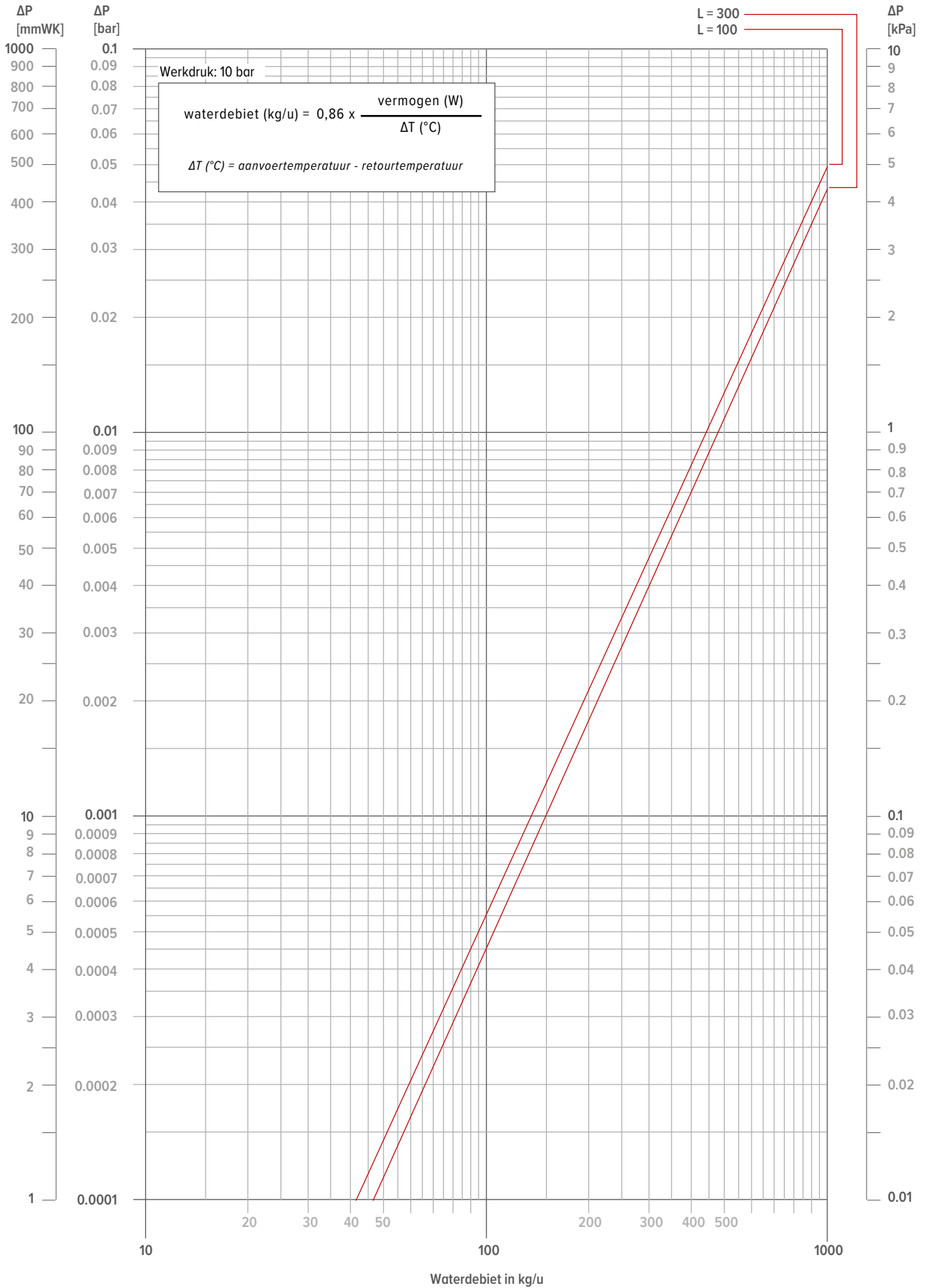

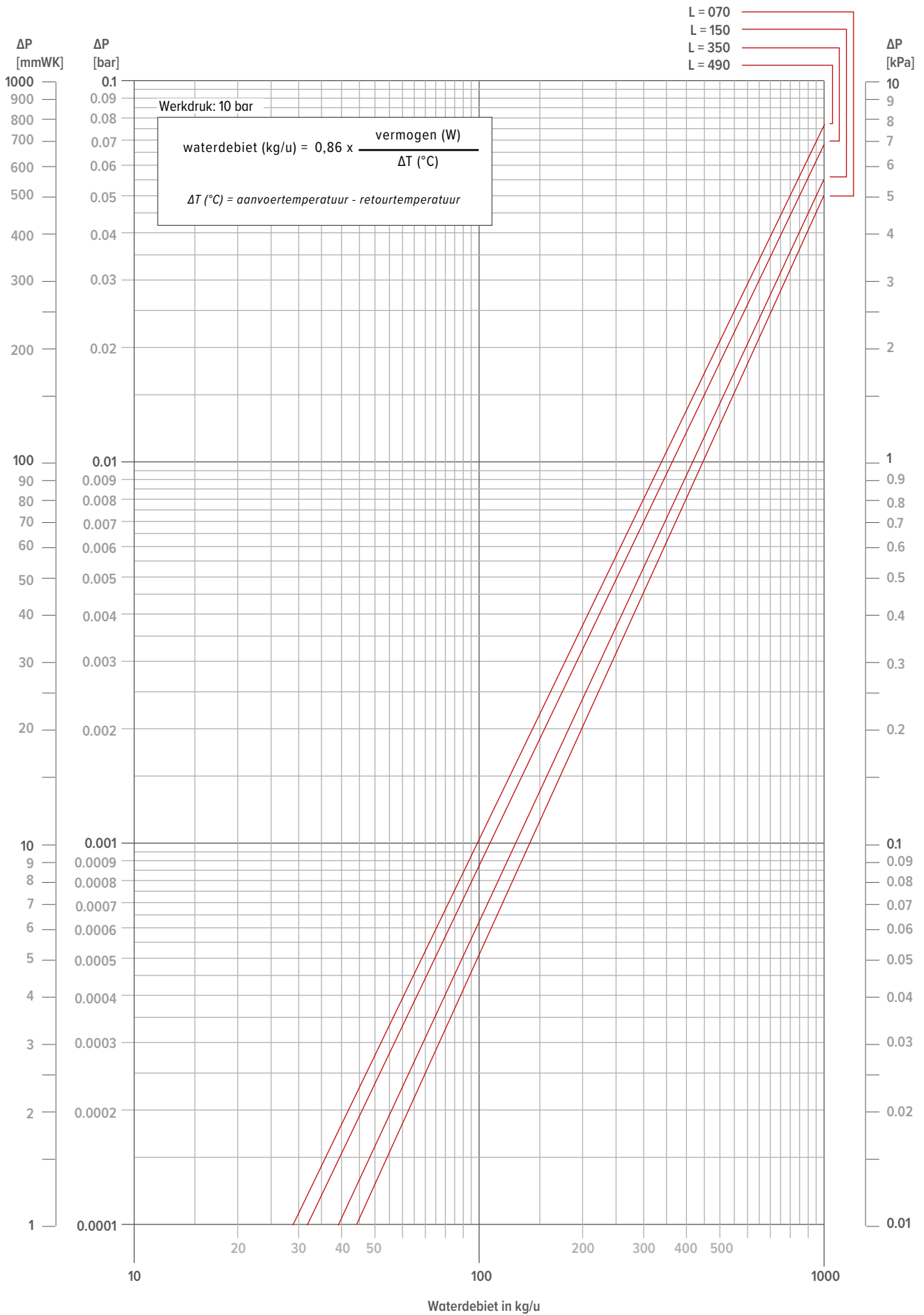

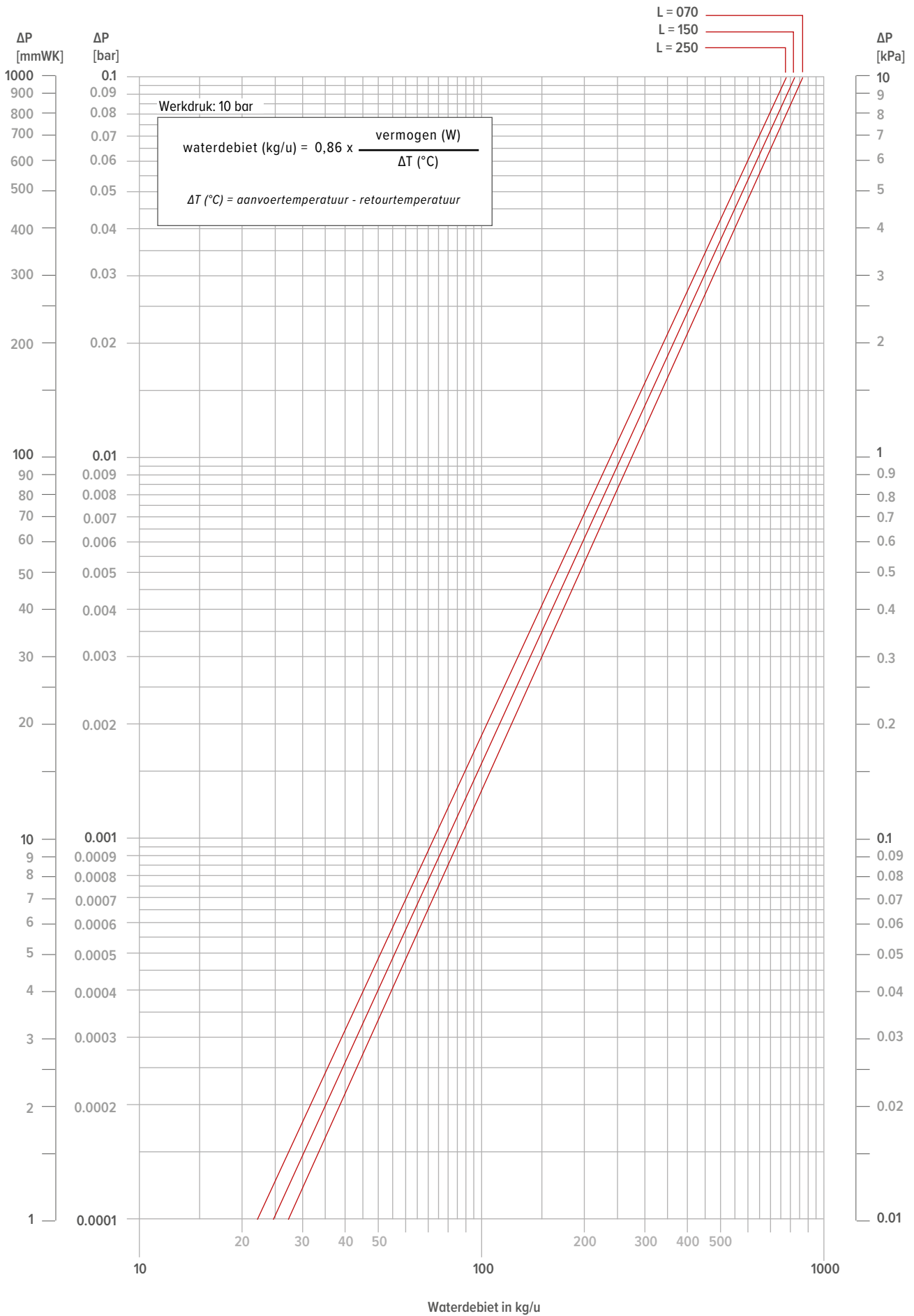

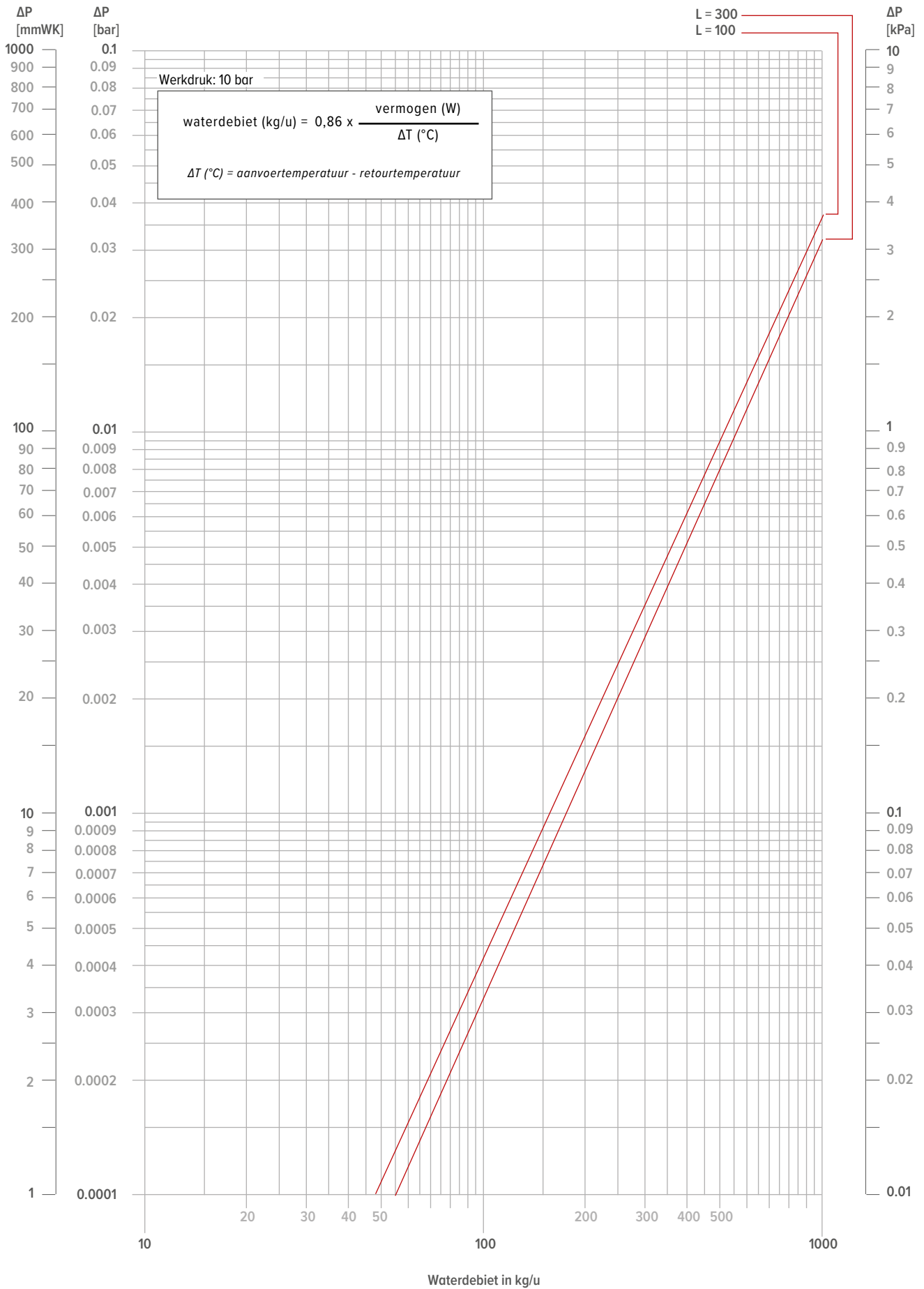

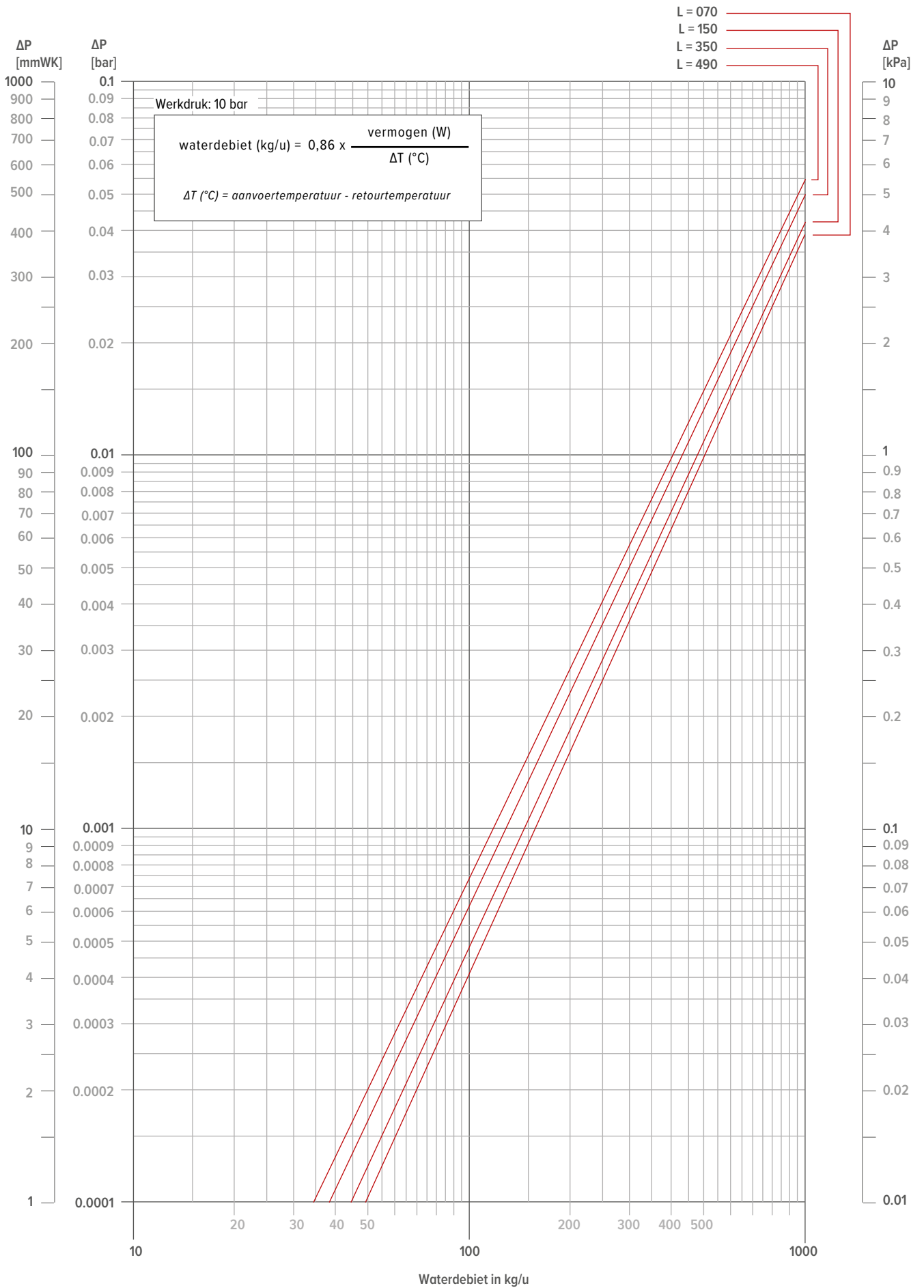

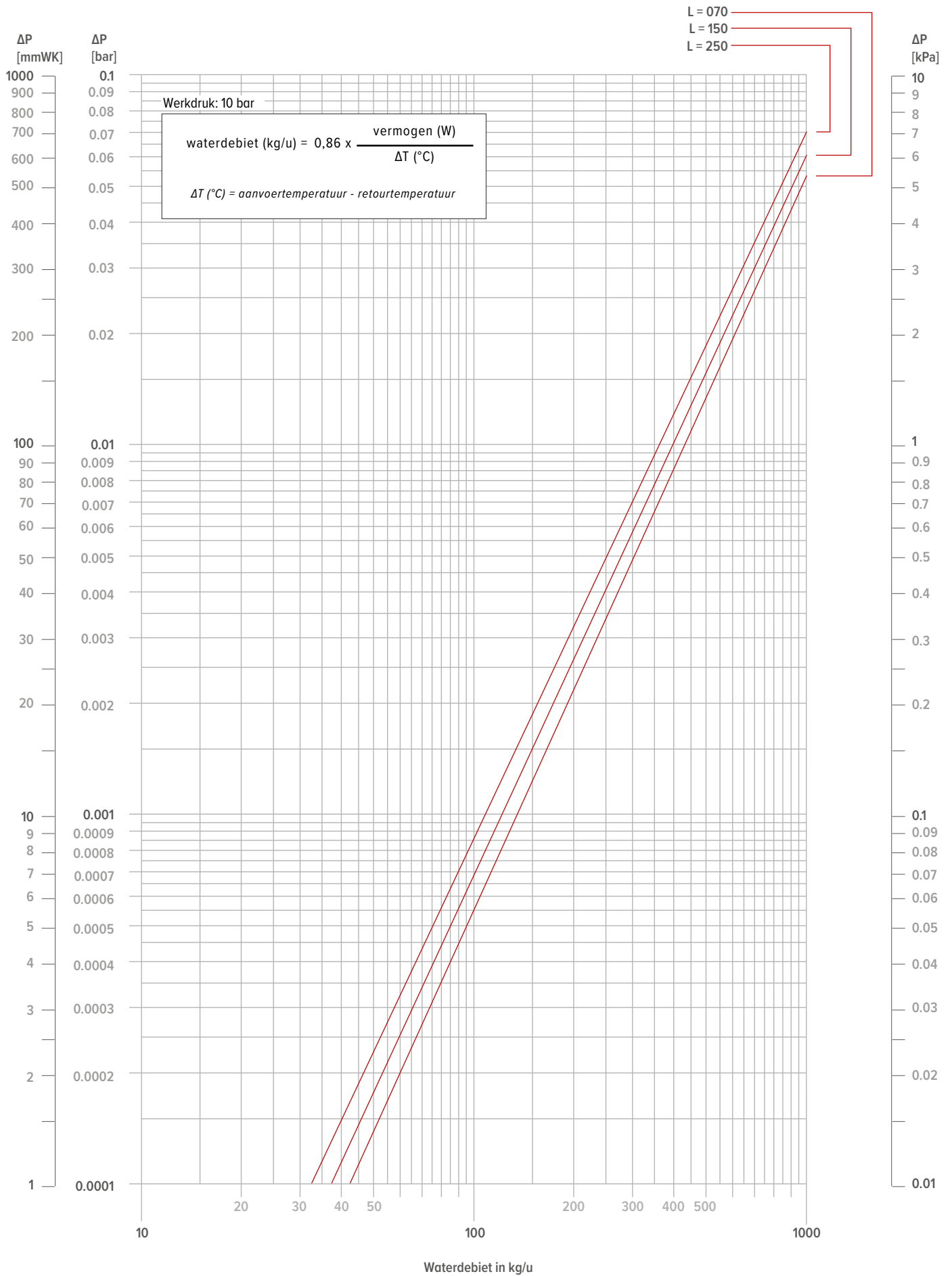







**jaga**

CLIMATE  
DESIGNERS

**BELGIË JAGA NV**

Nood aan advies? Maak een afspraak in het Jaga Advies Centrum!

Verbindingslaan 16  
3590 Diepenbeek

+32 (0) 11 29 41 11

info@jaga.be  
jaga.com