

# jaga

CLIMATE DESIGNERS



## STRADA



INFO@JAGA.BE 011 29 41 11

## STRADA HYBRID

Vous voulez plus de rendement à basse température, et/ou vous voulez du Light Cooling avec un Strada ? Optez alors pour Strada Hybrid.



## STRADA HYBRID MM

Vous voulez plus de rendement à basses températures, et/ou vous voulez du Light Cooling avec un Strada doté d'une connexion centrale ? Optez alors pour Strada Hybrid MM.



## DBH UPGRADE SET

Vous avez déjà un Strada, et vous souhaitez le mettre à niveau pour plus de rendement à basse température, et/ou vous voulez du Light Cooling ? Jetez alors un coup d'œil à la brochure du DBH Upgrade Set.

### AVANT

Seulement pour chauffer 

Strada H50 L100 Type 11



### APRÈS

Chauffer 

+

Breeze 

+

Refroidir 

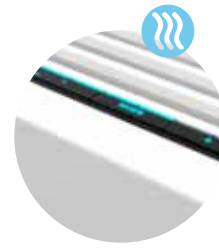
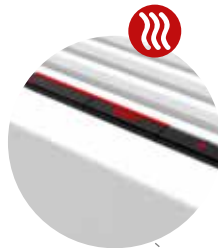

Light cooling avec toutes les pompes à chaleur dotées d'une fonction refroidissement.

Strada H50 L100 Type 11  
+ Kit DBH type 10

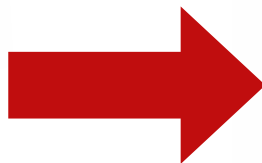

Unités de ventilateurs à clipser

# STRADA

|   |           |
|---|-----------|
| <b>TABLE DES MATIÈRES</b>   | <b>3</b>  |
| <b>DONNÉES TECHNIQUES</b>   | <b>5</b>  |
| <b>Dimensions</b>   | <b>5</b>  |
| <b>Option porte-serviette</b>                                     | <b>5</b>  |
| <b>Raccordement hydronique</b>                                    | <b>6</b>  |
| Connexion à gauche ou à droite<br>Avec commande en bas (Standard) | 6         |
| Connexion à gauche ou à droite avec commande au-dessus            | 6         |
| Connexion à gauche ou à droite avec commande à distance           | 6         |
| <b>Les raccords les plus utilisés</b>                             | <b>7</b>  |
| <b>Tableau technique</b>  | <b>8</b>  |
| Hauteur 020   | 8         |
| Hauteur 035   | 10        |
| Hauteur 050   | 12        |
| Hauteur 065   | 14        |
| Hauteur 095   | 16        |
| <b>Pièces détachées</b>   | <b>18</b> |
| <b>Coefficients de correction</b>                                 | <b>20</b> |
| <b>Pertes de charge</b>   | <b>21</b> |
| Type 06   | 21        |
| Type 10   | 22        |
| Type 11   | 23        |
| Type 15   | 24        |
| Type 16   | 25        |
| Type 20   | 26        |
| Type 21   | 27        |



## DIMENSIONS (en mm)

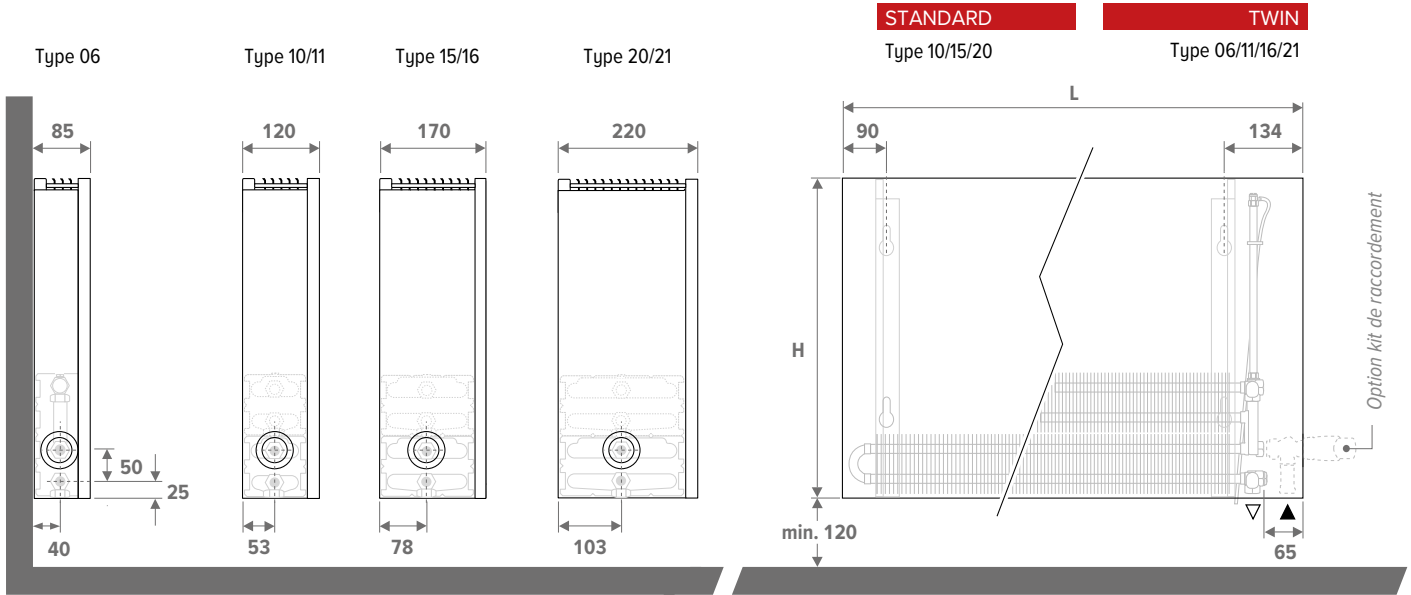

### LIVRAISON STANDARD

- échangeur de chaleur Low-H<sub>2</sub>O, avec revêtement anti-salissures et anti-poussière gris graphite (RAL 7024)
- consoles murales, set de fixation, purgeur incliné (hauteur 020) ou purgeur allongé 1/8" et bouchon de vidange 1/2"
- habillage partiellement prémonté pour raccordement en bas à gauche ou à droite
- plaque de recouvrement en look acier inoxydable pour le côté latéral de raccordement non utilisé

### COULEURS

Peinture écologique avec habillage en poudre anti-rayure et haute résistance UV

#### Couleurs standards

- couleur blanc signalisation RAL 9016 (133), laque soft touch, aspect satin, finement structurée
- gris sablé (001), laque métallique fine structure
- off-black (145), laque satinée soft touch légèrement structurée

#### Autres couleurs

voir carte de couleurs Jaga.  
 Supplément de prix en fonction de la longueur de l'appareil :

- Longueur < 100 cm
- Longueur de 100 cm à 200 cm
- Longueur > 200 cm

### PORTE-SERVIETTE

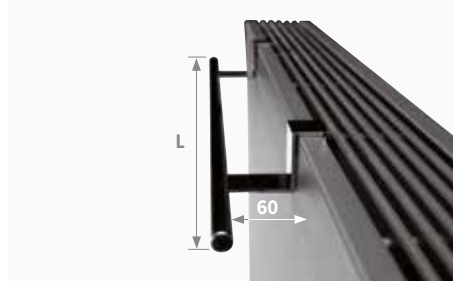

| CODE     | L   |                     |
|----------|-----|---------------------|
| 5501 001 | 560 | en aluminium chromé |
| 5501 002 | 660 | en aluminium chromé |

### CODE DE COMMANDE

STRW 020 050 06 XXX  
 Couleur  
 Type  
 Longueur  
 Hauteur



## STANDARD: CONNEXION À GAUCHE OU À DROITE AVEC COMMANDE EN BAS

Gauche ou droite vers le bas, vers le mur ou vers le sol. Raccordement mural par la face inférieure de l'habillage ou complètement invisible dans l'habillage.

L'installateur peut faire pivoter l'échangeur de chaleur pour une connexion à droite ou à gauche.

Jeux de raccords Eurocône possibles.: 101, 102, 103, 104, 181, 182, 183, 184, 222, 225, 226, 282, 285

Jeux de raccords M24 possibles: 11, 12, 13, 14, 25

### Exemple de raccord à droite (standard)

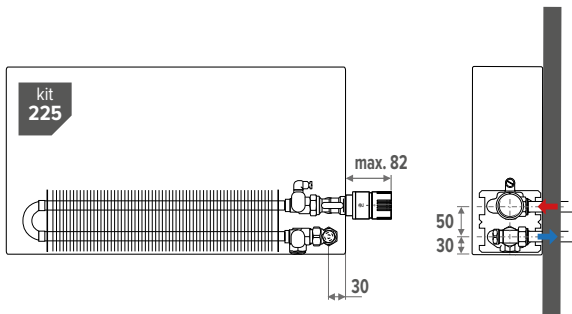

### Exemple de raccord à gauche

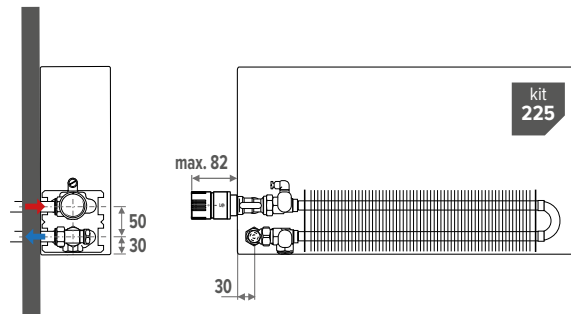

## CONNEXION À GAUCHE OU À DROITE AVEC COMMANDE AU-DESSUS

Ajoutez 30 (gauche) ou 60 (droite) au code du radiateur. EX. STRW.035 050 06 xxx 60

Jeux de raccords Eurocône possibles.: 115, 116, 117, 118

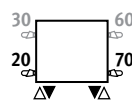

### Exemple de raccord à droite (standard)

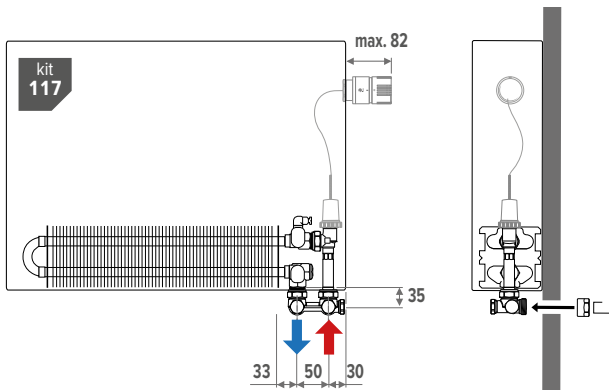

### Exemple de raccord à gauche

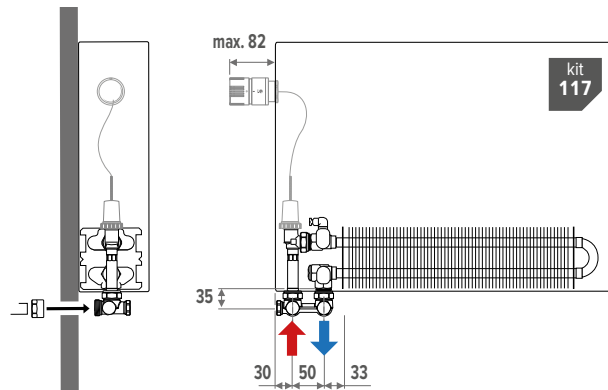

## CONNEXION À GAUCHE OU À DROITE AVEC COMMANDE À DISTANCE

Ajoutez 00 (côtés fermés) au code du radiateur. EX. STRW.035 050 06 xxx 00

Jeux de raccords Eurocône possibles.: 111, 112, 113, 114

Jeux de raccords M24 possibles: 28, 29

### Exemple de raccord à droite (standard)

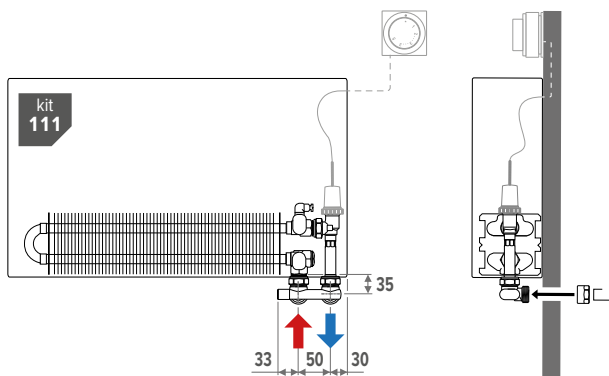

### Exemple de raccord à gauche

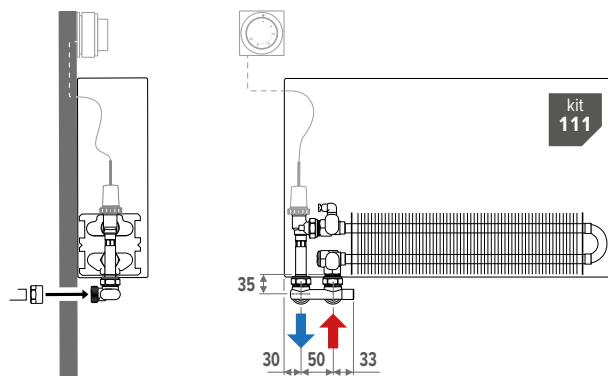

# STRADA

Informations détaillées sur les vannes, voir la brochure « Kits de raccordement & vannes »

# LES RACCORDEMENTS LES PLUS UTILISÉS

Vers le mur - DÉPART À L'EXTÉRIEUR  
Avec vanne H Jaga

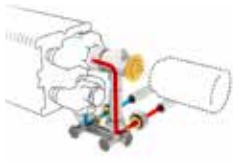

**kit 103 KVS: 0.8**  
**BITUBE / MONOTUBE**

|                   |    |  |
|-------------------|----|--|
| COLO HBSW AC 4... | AC |  |
| COLO HBSW AW 4... | AW |  |
| COLO HBSW AS 4... | AS |  |
| COLO HBSW AB 4... | AB |  |
| COLO HBSW JH 4... | JH |  |

indiquer code raccords de serrage

Avec vanne Gampper  
Vario DP Dynamique



**kit 183** contrôle automatique de débit (20 - 340 l/h)  
**BITUBE**

|                   |    |  |
|-------------------|----|--|
| COLO GASW AC 4... | AC |  |
| COLO GASW AW 4... | AW |  |
| COLO GASW AS 4... | AS |  |
| COLO GASW AB 4... | AB |  |
| COLO GASW JH 4... | JH |  |

indiquer code raccords de serrage

Vers le sol - DÉPART À L'EXTÉRIEUR  
Avec vanne H Jaga

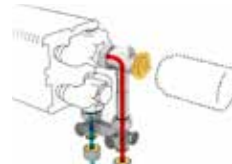

**kit 104 KVS: 0.8**  
**BITUBE / MONOTUBE**

|                   |    |  |
|-------------------|----|--|
| COLO HBSF AC 4... | AC |  |
| COLO HBSF AW 4... | AW |  |
| COLO HBSF AS 4... | AS |  |
| COLO HBSF AB 4... | AB |  |
| COLO HBSF JH 4... | JH |  |

indiquer code raccords de serrage

Avec vanne Gampper  
Vario DP Dynamique

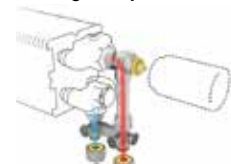

**kit 184** contrôle automatique de débit (20 - 340 l/h)  
**BITUBE**

|                   |    |  |
|-------------------|----|--|
| COLO GASF AC 4... | AC |  |
| COLO GASF AW 4... | AW |  |
| COLO GASF AS 4... | AS |  |
| COLO GASF AB 4... | AB |  |
| COLO GASF JH 4... | JH |  |

indiquer code raccords de serrage

Vers le mur - DÉPART À L'INTÉRIEUR  
Avec vanne Jaga Crossflow

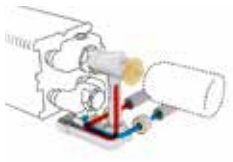

**kit 101 KVS: 0.8**  
**BITUBE**

|                   |    |  |
|-------------------|----|--|
| COLO HBCW AC 4... | AC |  |
| COLO HBCW AW 4... | AW |  |
| COLO HBCW AS 4... | AS |  |
| COLO HBCW AB 4... | AB |  |
| COLO HBCW JH 4... | JH |  |

indiquer code raccords de serrage

Avec vanne Gampper  
Vario DP Dynamique

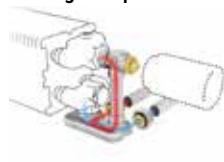

**kit 181** contrôle automatique de débit (20 - 340 l/h)  
**BITUBE**

|                   |    |  |
|-------------------|----|--|
| COLO GACW AC 4... | AC |  |
| COLO GACW AW 4... | AW |  |
| COLO GACW AS 4... | AS |  |
| COLO GACW AB 4... | AB |  |
| COLO GACW JH 4... | JH |  |

indiquer code raccords de serrage

Vers le sol - DÉPART À L'INTÉRIEUR  
Avec vanne Jaga Crossflow

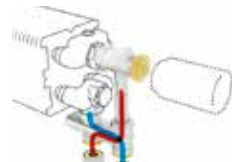

**kit 102 KVS: 0.8**  
**BITUBE**

|                   |    |  |
|-------------------|----|--|
| COLO HBCF AC 4... | AC |  |
| COLO HBCF AW 4... | AW |  |
| COLO HBCF AS 4... | AS |  |
| COLO HBCF AB 4... | AB |  |
| COLO HBCF JH 4... | JH |  |

indiquer code raccords de serrage

Avec vanne Gampper  
Vario DP Dynamique

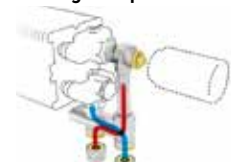

**kit 182** contrôle automatique de débit (20 - 340 l/h)  
**BITUBE**

|                   |    |  |
|-------------------|----|--|
| COLO GACF AC 4... | AC |  |
| COLO GACF AW 4... | AW |  |
| COLO GACF AS 4... | AS |  |
| COLO GACF AB 4... | AB |  |
| COLO GACF JH 4... | JH |  |

indiquer code raccords de serrage

Vers le mur - AU SEIN DE L'HABILLAGE  
Avec vanne Jaga



**kit 225 KVS: 0.8**  
**BITUBE**

|                  |    |  |
|------------------|----|--|
| COLO SW2 AC 4... | AC |  |
| COLO SW2 AW 4... | AW |  |
| COLO SW2 AS 4... | AS |  |
| COLO SW2 AB 4... | AB |  |
| COLO SW2 JH 4... | JH |  |

indiquer code raccords de serrage

Avec vanne Gampper  
Vario DP Dynamique

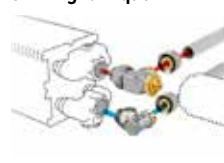

**kit 285** contrôle automatique de débit (20 - 340 l/h)  
**BITUBE**

|                  |    |  |
|------------------|----|--|
| COLO GW2 AC 4... | AC |  |
| COLO GW2 AW 4... | AW |  |
| COLO GW2 AS 4... | AS |  |
| COLO GW2 AB 4... | AB |  |
| COLO GW2 JH 4... | JH |  |

indiquer code raccords de serrage

Avec 2 vannes de retour



**kit 226**  
**BITUBE**

|                  |    |  |
|------------------|----|--|
| COLO LOA 00 4... | AC |  |
|------------------|----|--|

indiquer code raccords de serrage

## Raccords bicônes 3/4» Eurocone

| TUBE MÉTALLIQUE DE PRÉCISION |         | SYNTHÉTIQUE OU MULTICOUCHES PER/ALU |         |
|------------------------------|---------|-------------------------------------|---------|
| CODE                         | Tuyau Ø | CODE                                | Tuyau Ø |
| 112                          | 12/1    | 612                                 | 12/2    |
| 114                          | 14/1    | 614                                 | 14/2    |
| 115                          | 15/1    | 616                                 | 16/2    |
| 116                          | 16/1    | 618                                 | 18/2    |
| 118                          | 18/1    | 619                                 | 16/1,5  |
|                              |         | 620                                 | 20/2    |

Raccord mural Strada Type 06 à l'intérieur du caisson : jeu 25

# STRADA HAUTEUR 020 (STANDARD)

# TABLEAU TECHNIQUE

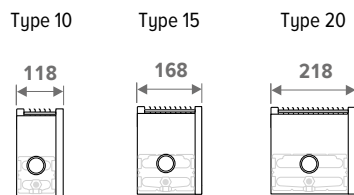

| HAUTEUR<br>H<br>cm | LONGUEUR<br>L<br>cm | TYPE<br>T | CHAUFFER<br>Température<br>ambiante 20°C |                |                |                | POIDS<br>kg | CONTENU EN EAU<br>L | CODE DE COMMANDE    |
|--------------------|---------------------|-----------|--|----------------|----------------|----------------|-------------|---------------------|---------------------|
|                    |                     |           | 45/40<br>Watts                           | 50/45<br>Watts | 55/45<br>Watts | 75/65<br>Watts |             |                     |                     |
| <b>STRW 020</b>    | <b>050</b>          | ---       | ---                                      | ---            | ---            | ---            | ---         | ---                 |                     |
|                    | <b>10</b>           |           | 106                                      | 141            | 158            | 328            | 4           | 0.3                 | STRW 020 050 10 XXX |
|                    | <b>15</b>           |           | 177                                      | 235            | 263            | 545            | 5           | 0.5                 | STRW 020 050 15 XXX |
|                    | <b>20</b>           |           | 249                                      | 330            | 370            | 766            | 6           | 0.7                 | STRW 020 050 20 XXX |
|                    | <b>060</b>          | ---       | ---                                      | ---            | ---            | ---            | ---         | ---                 |                     |
|                    | <b>10</b>           |           | 127                                      | 169            | 189            | 393            | 5           | 0.4                 | STRW 020 060 10 XXX |
|                    | <b>15</b>           |           | 212                                      | 282            | 316            | 654            | 6           | 0.6                 | STRW 020 060 15 XXX |
|                    | <b>20</b>           |           | 298                                      | 396            | 444            | 919            | 7           | 0.8                 | STRW 020 060 20 XXX |
|                    | <b>070</b>          | ---       | ---                                      | ---            | ---            | ---            | ---         | ---                 |                     |
|                    | <b>10</b>           |           | 148                                      | 197            | 221            | 459            | 5           | 0.5                 | STRW 020 070 10 XXX |
|                    | <b>15</b>           |           | 248                                      | 329            | 369            | 763            | 7           | 0.7                 | STRW 020 070 15 XXX |
|                    | <b>20</b>           |           | 348                                      | 462            | 518            | 1072           | 8           | 0.9                 | STRW 020 070 20 XXX |
|                    | <b>080</b>          | ---       | ---                                      | ---            | ---            | ---            | ---         | ---                 |                     |
|                    | <b>10</b>           |           | 169                                      | 225            | 252            | 524            | 6           | 0.5                 | STRW 020 080 10 XXX |
|                    | <b>15</b>           |           | 283                                      | 376            | 421            | 872            | 7           | 0.8                 | STRW 020 080 15 XXX |
|                    | <b>20</b>           |           | 398                                      | 529            | 592            | 1226           | 9           | 1.1                 | STRW 020 080 20 XXX |
|                    | <b>090</b>          | ---       | ---                                      | ---            | ---            | ---            | ---         | ---                 |                     |
|                    | <b>10</b>           |           | 191                                      | 254            | 284            | 590            | 6           | 0.6                 | STRW 020 090 10 XXX |
|                    | <b>15</b>           |           | 318                                      | 423            | 474            | 981            | 8           | 0.9                 | STRW 020 090 15 XXX |
|                    | <b>20</b>           |           | 448                                      | 595            | 666            | 1379           | 10          | 1.2                 | STRW 020 090 20 XXX |
|                    | <b>100</b>          | ---       | ---                                      | ---            | ---            | ---            | ---         | ---                 |                     |
|                    | <b>10</b>           |           | 212                                      | 282            | 316            | 655            | 7           | 0.7                 | STRW 020 100 10 XXX |
|                    | <b>15</b>           |           | 354                                      | 470            | 526            | 1090           | 9           | 1.0                 | STRW 020 100 15 XXX |
|                    | <b>20</b>           |           | 497                                      | 661            | 740            | 1532           | 11          | 1.3                 | STRW 020 100 20 XXX |
|                    | <b>110</b>          | ---       | ---                                      | ---            | ---            | ---            | ---         | ---                 |                     |
|                    | <b>10</b>           |           | 233                                      | 310            | 347            | 721            | 8           | 0.7                 | STRW 020 110 10 XXX |
|                    | <b>15</b>           |           | 389                                      | 517            | 579            | 1199           | 10          | 1.1                 | STRW 020 110 15 XXX |
|                    | <b>20</b>           |           | 547                                      | 727            | 814            | 1685           | 12          | 1.5                 | STRW 020 110 20 XXX |
|                    | <b>120</b>          | ---       | ---                                      | ---            | ---            | ---            | ---         | ---                 |                     |
|                    | <b>10</b>           |           | 254                                      | 338            | 379            | 786            | 8           | 0.8                 | STRW 020 120 10 XXX |
|                    | <b>15</b>           |           | 424                                      | 564            | 632            | 1308           | 11          | 1.2                 | STRW 020 120 15 XXX |
|                    | <b>20</b>           |           | 596                                      | 793            | 888            | 1838           | 13          | 1.6                 | STRW 020 120 20 XXX |
|                    | <b>140</b>          | ---       | ---                                      | ---            | ---            | ---            | ---         | ---                 |                     |
|                    | <b>10</b>           |           | 296                                      | 394            | 442            | 917            | 10          | 0.8                 | STRW 020 140 10 XXX |
|                    | <b>15</b>           |           | 495                                      | 658            | 737            | 1526           | 12          | 1.2                 | STRW 020 140 15 XXX |
|                    | <b>20</b>           |           | 696                                      | 925            | 1036           | 2145           | 15          | 1.6                 | STRW 020 140 20 XXX |
|                    | <b>160</b>          | ---       | ---                                      | ---            | ---            | ---            | ---         | ---                 |                     |
|                    | <b>10</b>           |           | 339                                      | 451            | 505            | 1048           | 11          | 1.0                 | STRW 020 160 10 XXX |
|                    | <b>15</b>           |           | 566                                      | 752            | 842            | 1744           | 14          | 1.6                 | STRW 020 160 15 XXX |
|                    | <b>20</b>           |           | 795                                      | 1057           | 1184           | 2451           | 17          | 2.1                 | STRW 020 160 20 XXX |
|                    | <b>180</b>          | ---       | ---                                      | ---            | ---            | ---            | ---         | ---                 |                     |
|                    | <b>10</b>           |           | 381                                      | 507            | 568            | 1179           | 12          | 1.2                 | STRW 020 180 10 XXX |
|                    | <b>15</b>           |           | 637                                      | 846            | 948            | 1962           | 15          | 1.8                 | STRW 020 180 15 XXX |
|                    | <b>20</b>           |           | 895                                      | 1190           | 1332           | 2758           | 19          | 2.4                 | STRW 020 180 20 XXX |
|                    | <b>200</b>          | ---       | ---                                      | ---            | ---            | ---            | ---         | ---                 |                     |
|                    | <b>10</b>           |           | 423                                      | 563            | 631            | 1310           | 13          | 1.3                 | STRW 020 200 10 XXX |
|                    | <b>15</b>           |           | 707                                      | 940            | 1053           | 2180           | 17          | 2.0                 | STRW 020 200 15 XXX |
|                    | <b>20</b>           |           | 994                                      | 1322           | 1480           | 3064           | 21          | 2.6                 | STRW 020 200 20 XXX |
|                    | <b>220</b>          | ---       | ---                                      | ---            | ---            | ---            | ---         | ---                 |                     |
|                    | <b>10</b>           |           | 466                                      | 620            | 694            | 1441           |             | 1.4                 | STRW 020 220 10 XXX |
|                    | <b>15</b>           |           | 778                                      | 1034           | 1158           | 2398           |             | 2.2                 | STRW 020 220 15 XXX |
|                    | <b>20</b>           |           | 1094                                     | 1454           | 1628           | 3370           |             | 2.9                 | STRW 020 220 20 XXX |
|                    | <b>240</b>          | ---       | ---                                      | ---            | ---            | ---            | ---         | ---                 |                     |
|                    | <b>10</b>           |           | 508                                      | 676            | 757            | 1572           | 16          | 1.6                 | STRW 020 240 10 XXX |
|                    | <b>15</b>           |           | 849                                      | 1128           | 1264           | 2616           | 20          | 2.4                 | STRW 020 240 15 XXX |
|                    | <b>20</b>           |           | 1193                                     | 1586           | 1776           | 3677           | 25          | 3.2                 | STRW 020 240 20 XXX |
|                    | <b>260</b>          | ---       | ---                                      | ---            | ---            | ---            | ---         | ---                 |                     |
|                    | <b>10</b>           |           | 550                                      | 732            | 820            | 1703           |             | 1.7                 | STRW 020 260 10 XXX |
|                    | <b>15</b>           |           | 920                                      | 1222           | 1369           | 2834           |             | 2.5                 | STRW 020 260 15 XXX |
|                    | <b>20</b>           |           | 1293                                     | 1718           | 1924           | 3983           |             | 3.4                 | STRW 020 260 20 XXX |
|                    | <b>280</b>          | ---       | ---                                      | ---            | ---            | ---            | ---         | ---                 |                     |
|                    | <b>10</b>           |           | 593                                      | 789            | 884            | 1834           | 19          | 1.8                 | STRW 020 280 10 XXX |
|                    | <b>15</b>           |           | 990                                      | 1316           | 1474           | 3052           | 24          | 2.7                 | STRW 020 280 15 XXX |
|                    | <b>20</b>           |           | 1392                                     | 1850           | 2072           | 4290           | 29          | 3.7                 | STRW 020 280 20 XXX |

Emission EN442 à 20°C

remplir code de couleur



# STRADA HAUTEUR 020 (TWIN)

# TABLEAU TECHNIQUE

Type 06

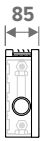

| HAUTEUR<br>H<br>cm | LONGUEUR<br>L<br>cm | TYPE<br>T | CHAUFFER<br>Température<br>ambiante 20°C |                |                |                | POIDS<br>kg | CONTENU EN EAU<br>L | CODE DE COMMANDE    |
|--------------------|---------------------|-----------|--|----------------|----------------|----------------|-------------|---------------------|---------------------|
|                    |                     |           | 45/40<br>Watts                           | 50/45<br>Watts | 55/45<br>Watts | 75/65<br>Watts |             |                     |                     |
| STRW 020           | 050                 | 06        | 87                                       | 116            | 130            | 269            | 4           | 0.3                 | STRW 020 050 06 XXX |
|                    |                     | 11        | ---                                      | ---            | ---            | ---            | ---         | ---                 |                     |
|                    |                     | 16        | ---                                      | ---            | ---            | ---            | ---         | ---                 |                     |
|                    |                     | 21        | ---                                      | ---            | ---            | ---            | ---         | ---                 |                     |
|                    | 060                 | 06        | 105                                      | 139            | 156            | 323            | 4           | 0.4                 | STRW 020 060 06 XXX |
|                    |                     | 11        | ---                                      | ---            | ---            | ---            | ---         | ---                 |                     |
|                    |                     | 16        | ---                                      | ---            | ---            | ---            | ---         | ---                 |                     |
|                    |                     | 21        | ---                                      | ---            | ---            | ---            | ---         | ---                 |                     |
|                    | 070                 | 06        | 122                                      | 162            | 182            | 377            | 5           | 0.4                 | STRW 020 070 06 XXX |
|                    |                     | 11        | ---                                      | ---            | ---            | ---            | ---         | ---                 |                     |
|                    |                     | 16        | ---                                      | ---            | ---            | ---            | ---         | ---                 |                     |
|                    |                     | 21        | ---                                      | ---            | ---            | ---            | ---         | ---                 |                     |
| 080                | 06                  | 139       | 185                                      | 207            | 430            | 5              | 0.5         | STRW 020 080 06 XXX |                     |
|                    | 11                  | ---       | ---                                      | ---            | ---            | ---            | ---         |                     |                     |
|                    | 16                  | ---       | ---                                      | ---            | ---            | ---            | ---         |                     |                     |
|                    | 21                  | ---       | ---                                      | ---            | ---            | ---            | ---         |                     |                     |
| 090                | 06                  | 157       | 209                                      | 234            | 484            | 6              | 0.6         | STRW 020 090 06 XXX |                     |
|                    | 11                  | ---       | ---                                      | ---            | ---            | ---            | 1.2         |                     |                     |
|                    | 16                  | ---       | ---                                      | ---            | ---            | ---            | ---         |                     |                     |
|                    | 21                  | ---       | ---                                      | ---            | ---            | ---            | ---         |                     |                     |
| 100                | 06                  | 174       | 232                                      | 260            | 538            | 6              | 0.6         | STRW 020 100 06 XXX |                     |
|                    | 11                  | ---       | ---                                      | ---            | ---            | ---            | ---         |                     |                     |
|                    | 16                  | ---       | ---                                      | ---            | ---            | ---            | ---         |                     |                     |
|                    | 21                  | ---       | ---                                      | ---            | ---            | ---            | ---         |                     |                     |
| 110                | 06                  | 192       | 255                                      | 286            | 592            | 7              | 0.7         | STRW 020 110 06 XXX |                     |
|                    | 11                  | ---       | ---                                      | ---            | ---            | ---            | ---         |                     |                     |
|                    | 16                  | ---       | ---                                      | ---            | ---            | ---            | ---         |                     |                     |
|                    | 21                  | ---       | ---                                      | ---            | ---            | ---            | ---         |                     |                     |
| 120                | 06                  | 209       | 278                                      | 312            | 646            | 7              | 0.8         | STRW 020 120 06 XXX |                     |
|                    | 11                  | ---       | ---                                      | ---            | ---            | ---            | ---         |                     |                     |
|                    | 16                  | ---       | ---                                      | ---            | ---            | ---            | ---         |                     |                     |
|                    | 21                  | ---       | ---                                      | ---            | ---            | ---            | ---         |                     |                     |
| 140                | 06                  | 244       | 324                                      | 363            | 753            | 8              | 0.8         | STRW 020 140 06 XXX |                     |
|                    | 11                  | ---       | ---                                      | ---            | ---            | ---            | ---         |                     |                     |
|                    | 16                  | ---       | ---                                      | ---            | ---            | ---            | ---         |                     |                     |
|                    | 21                  | ---       | ---                                      | ---            | ---            | ---            | ---         |                     |                     |
| 160                | 06                  | 279       | 371                                      | 415            | 861            | 10             | 1.0         | STRW 020 160 06 XXX |                     |
|                    | 11                  | ---       | ---                                      | ---            | ---            | ---            | ---         |                     |                     |
|                    | 16                  | ---       | ---                                      | ---            | ---            | ---            | ---         |                     |                     |
|                    | 21                  | ---       | ---                                      | ---            | ---            | ---            | ---         |                     |                     |
| 180                | 06                  | 314       | 417                                      | 467            | 968            | 11             | 1.2         | STRW 020 180 06 XXX |                     |
|                    | 11                  | ---       | ---                                      | ---            | ---            | ---            | ---         |                     |                     |
|                    | 16                  | ---       | ---                                      | ---            | ---            | ---            | ---         |                     |                     |
|                    | 21                  | ---       | ---                                      | ---            | ---            | ---            | ---         |                     |                     |
| 200                | 06                  | 349       | 464                                      | 519            | 1076           | 12             | 1.3         | STRW 020 200 06 XXX |                     |
|                    | 11                  | ---       | ---                                      | ---            | ---            | ---            | ---         |                     |                     |
|                    | 16                  | ---       | ---                                      | ---            | ---            | ---            | ---         |                     |                     |
|                    | 21                  | ---       | ---                                      | ---            | ---            | ---            | ---         |                     |                     |
| 220                | 06                  | 384       | 510                                      | 571            | 1184           | 14             | 1.4         | STRW 020 220 06 XXX |                     |
|                    | 11                  | ---       | ---                                      | ---            | ---            | ---            | ---         |                     |                     |
|                    | 16                  | ---       | ---                                      | ---            | ---            | ---            | ---         |                     |                     |
|                    | 21                  | ---       | ---                                      | ---            | ---            | ---            | ---         |                     |                     |
| 240                | 06                  | 418       | 556                                      | 623            | 1291           | 14             | 1.5         | STRW 020 240 06 XXX |                     |
|                    | 11                  | ---       | ---                                      | ---            | ---            | ---            | ---         |                     |                     |
|                    | 16                  | ---       | ---                                      | ---            | ---            | ---            | ---         |                     |                     |
|                    | 21                  | ---       | ---                                      | ---            | ---            | ---            | ---         |                     |                     |
| 260                | 06                  | 453       | 603                                      | 675            | 1399           | 16             | 1.7         | STRW 020 260 06 XXX |                     |
|                    | 11                  | ---       | ---                                      | ---            | ---            | ---            | ---         |                     |                     |
|                    | 16                  | ---       | ---                                      | ---            | ---            | ---            | ---         |                     |                     |
|                    | 21                  | ---       | ---                                      | ---            | ---            | ---            | ---         |                     |                     |
| 280                | 06                  | 488       | 649                                      | 727            | 1506           | 16             | 1.8         | STRW 020 280 06 XXX |                     |
|                    | 11                  | ---       | ---                                      | ---            | ---            | ---            | ---         |                     |                     |
|                    | 16                  | ---       | ---                                      | ---            | ---            | ---            | ---         |                     |                     |
|                    | 21                  | ---       | ---                                      | ---            | ---            | ---            | ---         |                     |                     |

Émission EN442 à 20°C

remplir code de couleur

# STRADA HAUTEUR 035 (STANDARD)

# TABLEAU TECHNIQUE

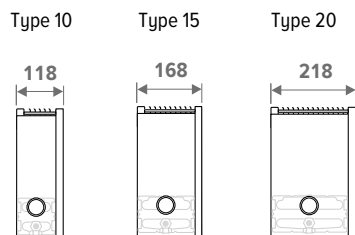

| HAUTEUR<br>H<br>cm | LONGUEUR<br>L<br>cm | TYPE<br>T | CHAUFFER<br>Temperature<br>ambiante 20°C |                |                |                | POIDS<br>kg         | CONTENU EN EAU<br>L | CODE DE COMMANDE |
|--------------------|---------------------|-----------|--|----------------|----------------|----------------|---------------------|---------------------|------------------|
|                    |                     |           | 45/40<br>Watts                           | 50/45<br>Watts | 55/45<br>Watts | 75/65<br>Watts |                     |                     |                  |
| STRW 035           | 050                 | ---       | ---                                      | ---            | ---            | ---            | ---                 | ---                 |                  |
| 10                 | 147                 | 195       | 218                                      | 449            | 5              | 0.3            | STRW 035 050 10 XXX |                     |                  |
| 15                 | 242                 | 320       | 358                                      | 735            | 7              | 0.5            | STRW 035 050 15 XXX |                     |                  |
| 20                 | 339                 | 449       | 502                                      | 1030           | 8              | 0.7            | STRW 035 050 20 XXX |                     |                  |
| 060                | ---                 | ---       | ---                                      | ---            | ---            | ---            | ---                 |                     |                  |
| 10                 | 176                 | 234       | 262                                      | 539            | 6              | 0.4            | STRW 035 060 10 XXX |                     |                  |
| 15                 | 290                 | 385       | 430                                      | 882            | 8              | 0.6            | STRW 035 060 15 XXX |                     |                  |
| 20                 | 407                 | 539       | 603                                      | 1236           | 9              | 0.8            | STRW 035 060 20 XXX |                     |                  |
| 070                | ---                 | ---       | ---                                      | ---            | ---            | ---            | ---                 |                     |                  |
| 10                 | 206                 | 273       | 305                                      | 629            | 7              | 0.5            | STRW 035 070 10 XXX |                     |                  |
| 15                 | 339                 | 449       | 502                                      | 1029           | 9              | 0.7            | STRW 035 070 15 XXX |                     |                  |
| 20                 | 475                 | 629       | 703                                      | 1442           | 10             | 0.9            | STRW 035 070 20 XXX |                     |                  |
| 080                | ---                 | ---       | ---                                      | ---            | ---            | ---            | ---                 |                     |                  |
| 10                 | 235                 | 311       | 348                                      | 718            | 8              | 0.5            | STRW 035 080 10 XXX |                     |                  |
| 15                 | 387                 | 513       | 573                                      | 1176           | 10             | 0.8            | STRW 035 080 15 XXX |                     |                  |
| 20                 | 543                 | 718       | 803                                      | 1648           | 11             | 1.1            | STRW 035 080 20 XXX |                     |                  |
| 090                | ---                 | ---       | ---                                      | ---            | ---            | ---            | ---                 |                     |                  |
| 10                 | 264                 | 350       | 392                                      | 808            | 9              | 0.6            | STRW 035 090 10 XXX |                     |                  |
| 15                 | 436                 | 577       | 645                                      | 1323           | 10             | 0.9            | STRW 035 090 15 XXX |                     |                  |
| 20                 | 610                 | 808       | 904                                      | 1854           | 13             | 1.2            | STRW 035 090 20 XXX |                     |                  |
| 100                | ---                 | ---       | ---                                      | ---            | ---            | ---            | ---                 |                     |                  |
| 10                 | 294                 | 389       | 436                                      | 898            | 9              | 0.7            | STRW 035 100 10 XXX |                     |                  |
| 15                 | 484                 | 641       | 717                                      | 1470           | 11             | 1.0            | STRW 035 100 15 XXX |                     |                  |
| 20                 | 678                 | 898       | 1004                                     | 2060           | 14             | 1.3            | STRW 035 100 20 XXX |                     |                  |
| 110                | ---                 | ---       | ---                                      | ---            | ---            | ---            | ---                 |                     |                  |
| 10                 | 323                 | 428       | 479                                      | 988            | 10             | 0.7            | STRW 035 110 10 XXX |                     |                  |
| 15                 | 532                 | 705       | 788                                      | 1617           | 12             | 1.1            | STRW 035 110 15 XXX |                     |                  |
| 20                 | 746                 | 988       | 1105                                     | 2266           | 15             | 1.5            | STRW 035 110 20 XXX |                     |                  |
| 120                | ---                 | ---       | ---                                      | ---            | ---            | ---            | ---                 |                     |                  |
| 10                 | 352                 | 467       | 523                                      | 1078           | 11             | 0.8            | STRW 035 120 10 XXX |                     |                  |
| 15                 | 581                 | 769       | 860                                      | 1764           | 13             | 1.2            | STRW 035 120 15 XXX |                     |                  |
| 20                 | 814                 | 1078      | 1205                                     | 2472           | 16             | 1.6            | STRW 035 120 20 XXX |                     |                  |
| 140                | ---                 | ---       | ---                                      | ---            | ---            | ---            | ---                 |                     |                  |
| 10                 | 411                 | 545       | 610                                      | 1257           | 13             | 0.8            | STRW 035 140 10 XXX |                     |                  |
| 15                 | 678                 | 897       | 1003                                     | 2058           | 16             | 1.2            | STRW 035 140 15 XXX |                     |                  |
| 20                 | 949                 | 1257      | 1406                                     | 2884           | 19             | 1.6            | STRW 035 140 20 XXX |                     |                  |
| 160                | ---                 | ---       | ---                                      | ---            | ---            | ---            | ---                 |                     |                  |
| 10                 | 470                 | 623       | 697                                      | 1437           | 14             | 1.0            | STRW 035 160 10 XXX |                     |                  |
| 15                 | 774                 | 1025      | 1147                                     | 2352           | 18             | 1.6            | STRW 035 160 15 XXX |                     |                  |
| 20                 | 1085                | 1437      | 1607                                     | 3296           | 21             | 2.1            | STRW 035 160 20 XXX |                     |                  |
| 180                | ---                 | ---       | ---                                      | ---            | ---            | ---            | ---                 |                     |                  |
| 10                 | 528                 | 701       | 784                                      | 1616           | 16             | 1.2            | STRW 035 180 10 XXX |                     |                  |
| 15                 | 871                 | 1154      | 1290                                     | 2646           | 20             | 1.8            | STRW 035 180 15 XXX |                     |                  |
| 20                 | 1221                | 1617      | 1808                                     | 3708           | 23             | 2.4            | STRW 035 180 20 XXX |                     |                  |
| 200                | ---                 | ---       | ---                                      | ---            | ---            | ---            | ---                 |                     |                  |
| 10                 | 587                 | 779       | 872                                      | 1796           | 17             | 1.3            | STRW 035 200 10 XXX |                     |                  |
| 15                 | 968                 | 1282      | 1433                                     | 2940           | 21             | 2.0            | STRW 035 200 15 XXX |                     |                  |
| 20                 | 1356                | 1796      | 2009                                     | 4120           | 25             | 2.6            | STRW 035 200 20 XXX |                     |                  |
| 220                | ---                 | ---       | ---                                      | ---            | ---            | ---            | ---                 |                     |                  |
| 10                 | 695                 | 922       | 1031                                     | 2119           | 14             | 1.4            | STRW 035 220 10 XXX |                     |                  |
| 15                 | 1140                | 1509      | 1686                                     | 3450           | 2.2            | 2.2            | STRW 035 220 15 XXX |                     |                  |
| 20                 | 1598                | 2114      | 2363                                     | 4831           | 2.9            | 2.9            | STRW 035 220 20 XXX |                     |                  |
| 240                | ---                 | ---       | ---                                      | ---            | ---            | ---            | ---                 |                     |                  |
| 10                 | 704                 | 934       | 1046                                     | 2155           | 21             | 1.6            | STRW 035 240 10 XXX |                     |                  |
| 15                 | 1161                | 1538      | 1720                                     | 3528           | 26             | 2.4            | STRW 035 240 15 XXX |                     |                  |
| 20                 | 1628                | 2155      | 2410                                     | 4944           | 30             | 3.2            | STRW 035 240 20 XXX |                     |                  |
| 260                | ---                 | ---       | ---                                      | ---            | ---            | ---            | ---                 |                     |                  |
| 10                 | 822                 | 1089      | 1218                                     | 2504           | 1.7            | 1.7            | STRW 035 260 10 XXX |                     |                  |
| 15                 | 1348                | 1783      | 1993                                     | 4077           | 2.5            | 2.5            | STRW 035 260 15 XXX |                     |                  |
| 20                 | 1889                | 2498      | 2792                                     | 5710           | 3.4            | 3.4            | STRW 035 260 20 XXX |                     |                  |
| 280                | ---                 | ---       | ---                                      | ---            | ---            | ---            | ---                 |                     |                  |
| 10                 | 822                 | 1090      | 1220                                     | 2514           | 24             | 1.8            | STRW 035 280 10 XXX |                     |                  |
| 15                 | 1355                | 1794      | 2007                                     | 4116           | 29             | 2.7            | STRW 035 280 15 XXX |                     |                  |
| 20                 | 1899                | 2515      | 2812                                     | 5768           | 35             | 3.7            | STRW 035 280 20 XXX |                     |                  |

Émission EN442 à 20°C

remplir code de couleur

# STRADA HAUTEUR 035 (TWIN)

# TABLEAU TECHNIQUE

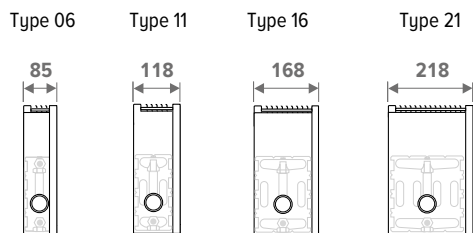

| HAUTEUR<br>H<br>cm  | LONGUEUR<br>L<br>cm | TYPE<br>T | CHAUFFEUR<br>Temperature<br>ambiante 20°C |                |                |                | POIDS<br>kg | CONTENU EN EAU<br>L | CODE DE COMMANDE    |
|---------------------|---------------------|-----------|---|----------------|----------------|----------------|-------------|---------------------|---------------------|
|                     |                     |           | 45/40<br>Watts                            | 50/45<br>Watts | 55/45<br>Watts | 75/65<br>Watts |             |                     |                     |
| <b>STRW 035 050</b> | <b>06</b>           | 06        | 130                                       | 172            | 192            | 395            | 5           | 0.3                 | STRW 035 050 06 XXX |
|                     |                     | 11        | 189                                       | 253            | 284            | 598            | 6           | 0.7                 | STRW 035 050 11 XXX |
|                     |                     | 16        | 249                                       | 334            | 375            | 797            | 8           | 1.0                 | STRW 035 050 16 XXX |
|                     |                     | 21        | 326                                       | 439            | 494            | 1057           | 9           | 1.3                 | STRW 035 050 21 XXX |
| <b>060</b>          | <b>06</b>           | 06        | 156                                       | 206            | 231            | 474            | 6           | 0.4                 | STRW 035 060 06 XXX |
|                     |                     | 11        | 227                                       | 304            | 341            | 718            | 7           | 0.8                 | STRW 035 060 11 XXX |
|                     |                     | 16        | 298                                       | 400            | 450            | 956            | 9           | 1.2                 | STRW 035 060 16 XXX |
|                     |                     | 21        | 391                                       | 526            | 593            | 1268           | 11          | 1.6                 | STRW 035 060 21 XXX |
| <b>070</b>          | <b>06</b>           | 06        | 182                                       | 241            | 269            | 553            | 6           | 0.4                 | STRW 035 070 06 XXX |
|                     |                     | 11        | 265                                       | 354            | 398            | 837            | 8           | 0.9                 | STRW 035 070 11 XXX |
|                     |                     | 16        | 348                                       | 467            | 525            | 1115           | 10          | 1.4                 | STRW 035 070 16 XXX |
|                     |                     | 21        | 456                                       | 614            | 692            | 1480           | 12          | 1.9                 | STRW 035 070 21 XXX |
| <b>080</b>          | <b>06</b>           | 06        | 208                                       | 275            | 308            | 632            | 7           | 0.5                 | STRW 035 080 06 XXX |
|                     |                     | 11        | 303                                       | 405            | 455            | 957            | 9           | 1.1                 | STRW 035 080 11 XXX |
|                     |                     | 16        | 397                                       | 533            | 600            | 1274           | 11          | 1.6                 | STRW 035 080 16 XXX |
|                     |                     | 21        | 521                                       | 702            | 790            | 1691           | 13          | 2.1                 | STRW 035 080 21 XXX |
| <b>090</b>          | <b>06</b>           | 06        | 234                                       | 309            | 346            | 711            | 8           | 0.6                 | STRW 035 090 06 XXX |
|                     |                     | 11        | 340                                       | 455            | 511            | 1076           | 10          | 1.2                 | STRW 035 090 11 XXX |
|                     |                     | 16        | 447                                       | 600            | 675            | 1434           | 13          | 1.8                 | STRW 035 090 16 XXX |
|                     |                     | 21        | 587                                       | 790            | 889            | 1903           | 15          | 2.4                 | STRW 035 090 21 XXX |
| <b>100</b>          | <b>06</b>           | 06        | 259                                       | 344            | 385            | 790            | 9           | 0.6                 | STRW 035 100 06 XXX |
|                     |                     | 11        | 378                                       | 506            | 568            | 1196           | 11          | 1.3                 | STRW 035 100 11 XXX |
|                     |                     | 16        | 497                                       | 667            | 750            | 1593           | 14          | 2.0                 | STRW 035 100 16 XXX |
|                     |                     | 21        | 652                                       | 878            | 988            | 2114           | 16          | 2.7                 | STRW 035 100 21 XXX |
| <b>110</b>          | <b>06</b>           | 06        | 285                                       | 378            | 423            | 869            | 9           | 0.7                 | STRW 035 110 06 XXX |
|                     |                     | 11        | 416                                       | 557            | 625            | 1316           | 12          | 1.5                 | STRW 035 110 11 XXX |
|                     |                     | 16        | 546                                       | 733            | 825            | 1752           | 15          | 2.2                 | STRW 035 110 16 XXX |
|                     |                     | 21        | 717                                       | 965            | 1086           | 2325           | 18          | 2.9                 | STRW 035 110 21 XXX |
| <b>120</b>          | <b>06</b>           | 06        | 311                                       | 413            | 461            | 948            | 10          | 0.8                 | STRW 035 120 06 XXX |
|                     |                     | 11        | 454                                       | 607            | 682            | 1435           | 13          | 1.6                 | STRW 035 120 11 XXX |
|                     |                     | 16        | 596                                       | 800            | 900            | 1912           | 16          | 2.4                 | STRW 035 120 16 XXX |
|                     |                     | 21        | 782                                       | 1053           | 1186           | 2537           | 19          | 3.2                 | STRW 035 120 21 XXX |
| <b>140</b>          | <b>06</b>           | 06        | 363                                       | 481            | 538            | 1106           | 12          | 0.8                 | STRW 035 140 06 XXX |
|                     |                     | 11        | 530                                       | 708            | 795            | 1674           | 15          | 1.6                 | STRW 035 140 11 XXX |
|                     |                     | 16        | 695                                       | 934            | 1050           | 2230           | 19          | 2.4                 | STRW 035 140 16 XXX |
|                     |                     | 21        | 913                                       | 1229           | 1383           | 2960           | 23          | 3.2                 | STRW 035 140 21 XXX |
| <b>160</b>          | <b>06</b>           | 06        | 415                                       | 550            | 615            | 1264           | 13          | 1.0                 | STRW 035 160 06 XXX |
|                     |                     | 11        | 605                                       | 810            | 909            | 1914           | 17          | 2.1                 | STRW 035 160 11 XXX |
|                     |                     | 16        | 795                                       | 1067           | 1200           | 2549           | 21          | 3.2                 | STRW 035 160 16 XXX |
|                     |                     | 21        | 1043                                      | 1404           | 1580           | 3382           | 25          | 4.3                 | STRW 035 160 21 XXX |
| <b>180</b>          | <b>06</b>           | 06        | 467                                       | 619            | 692            | 1422           | 15          | 1.2                 | STRW 035 180 06 XXX |
|                     |                     | 11        | 681                                       | 911            | 1023           | 2153           | 19          | 2.4                 | STRW 035 180 11 XXX |
|                     |                     | 16        | 894                                       | 1200           | 1349           | 2867           | 23          | 3.6                 | STRW 035 180 16 XXX |
|                     |                     | 21        | 1173                                      | 1580           | 1778           | 3805           | 28          | 4.8                 | STRW 035 180 21 XXX |
| <b>200</b>          | <b>06</b>           | 06        | 519                                       | 688            | 769            | 1580           | 16          | 1.3                 | STRW 035 200 06 XXX |
|                     |                     | 11        | 757                                       | 1012           | 1136           | 2392           | 20          | 2.7                 | STRW 035 200 11 XXX |
|                     |                     | 16        | 993                                       | 1334           | 1500           | 3186           | 25          | 4.0                 | STRW 035 200 16 XXX |
|                     |                     | 21        | 1304                                      | 1755           | 1976           | 4228           | 31          | 5.3                 | STRW 035 200 21 XXX |
| <b>220</b>          | <b>06</b>           | 06        | 586                                       | 771            | 861            | 1738           | 1.4         |                     | STRW 035 220 06 XXX |
|                     |                     | 11        | 880                                       | 1177           | 1322           | 2781           | 2.9         |                     | STRW 035 220 11 XXX |
|                     |                     | 16        | 1164                                      | 1564           | 1759           | 3740           | 4.4         |                     | STRW 035 220 16 XXX |
|                     |                     | 21        | 1536                                      | 2071           | 2332           | 5003           | 5.9         |                     | STRW 035 220 21 XXX |
| <b>240</b>          | <b>06</b>           | 06        | 623                                       | 825            | 923            | 1896           | 20          | 1.5                 | STRW 035 240 06 XXX |
|                     |                     | 11        | 908                                       | 1214           | 1363           | 2870           | 24          | 3.2                 | STRW 035 240 11 XXX |
|                     |                     | 16        | 1192                                      | 1600           | 1799           | 3823           | 30          | 4.8                 | STRW 035 240 16 XXX |
|                     |                     | 21        | 1564                                      | 2106           | 2371           | 5074           | 37          | 6.4                 | STRW 035 240 21 XXX |
| <b>260</b>          | <b>06</b>           | 06        | 693                                       | 912            | 1017           | 2054           | 1.7         |                     | STRW 035 260 06 XXX |
|                     |                     | 11        | 1040                                      | 1391           | 1562           | 3286           | 3.5         |                     | STRW 035 260 11 XXX |
|                     |                     | 16        | 1376                                      | 1848           | 2078           | 4420           | 5.1         |                     | STRW 035 260 16 XXX |
|                     |                     | 21        | 1816                                      | 2447           | 2755           | 5912           | 6.9         |                     | STRW 035 260 21 XXX |
| <b>280</b>          | <b>06</b>           | 06        | 726                                       | 963            | 1077           | 2212           | 22          | 1.8                 | STRW 035 280 06 XXX |
|                     |                     | 11        | 1059                                      | 1417           | 1591           | 3349           | 28          | 3.7                 | STRW 035 280 11 XXX |
|                     |                     | 16        | 1391                                      | 1867           | 2099           | 4460           | 34          | 5.5                 | STRW 035 280 16 XXX |
|                     |                     | 21        | 1825                                      | 2457           | 2766           | 5919           | 43          | 7.4                 | STRW 035 280 21 XXX |

Émission EN442 à 20°C

remplir code de couleur

# STRADA HAUTEUR 050 (STANDARD)

# TABLEAU TECHNIQUE

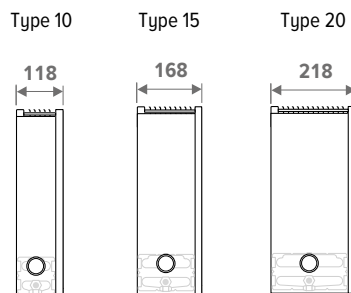

| HAUTEUR<br>H<br>cm | LONGUEUR<br>L<br>cm | TYPE<br>T | CHAUFFER<br>Température<br>ambiante 20°C |                |                |                | POIDS<br>kg         | CONTENU EN EAU<br>L | CODE DE COMMANDE |
|--------------------|---------------------|-----------|--|----------------|----------------|----------------|---------------------|---------------------|------------------|
|                    |                     |           | 45/40<br>Watts                           | 50/45<br>Watts | 55/45<br>Watts | 75/65<br>Watts |                     |                     |                  |
| STRW 050           | 050                 | ---       | ---                                      | ---            | ---            | ---            | ---                 | ---                 |                  |
| 10                 | 178                 | 235       | 263                                      | 538            | 7              | 0.3            | STRW 050 050 10 XXX |                     |                  |
| 15                 | 289                 | 382       | 426                                      | 867            | 8              | 0.5            | STRW 050 050 15 XXX |                     |                  |
| 20                 | 405                 | 534       | 597                                      | 1213           | 10             | 0.7            | STRW 050 050 20 XXX |                     |                  |
| 060                | ---                 | ---       | ---                                      | ---            | ---            | ---            | ---                 |                     |                  |
| 10                 | 214                 | 282       | 316                                      | 646            | 8              | 0.4            | STRW 050 060 10 XXX |                     |                  |
| 15                 | 347                 | 458       | 511                                      | 1040           | 9              | 0.6            | STRW 050 060 15 XXX |                     |                  |
| 20                 | 486                 | 641       | 716                                      | 1455           | 11             | 0.8            | STRW 050 060 20 XXX |                     |                  |
| 070                | ---                 | ---       | ---                                      | ---            | ---            | ---            | ---                 |                     |                  |
| 10                 | 249                 | 329       | 368                                      | 753            | 9              | 0.5            | STRW 050 070 10 XXX |                     |                  |
| 15                 | 405                 | 535       | 597                                      | 1214           | 11             | 0.7            | STRW 050 070 15 XXX |                     |                  |
| 20                 | 567                 | 748       | 835                                      | 1698           | 12             | 0.9            | STRW 050 070 20 XXX |                     |                  |
| 080                | ---                 | ---       | ---                                      | ---            | ---            | ---            | ---                 |                     |                  |
| 10                 | 285                 | 376       | 421                                      | 861            | 10             | 0.5            | STRW 050 080 10 XXX |                     |                  |
| 15                 | 463                 | 611       | 682                                      | 1387           | 12             | 0.8            | STRW 050 080 15 XXX |                     |                  |
| 20                 | 647                 | 854       | 954                                      | 1940           | 14             | 1.1            | STRW 050 080 20 XXX |                     |                  |
| 090                | ---                 | ---       | ---                                      | ---            | ---            | ---            | ---                 |                     |                  |
| 10                 | 320                 | 423       | 473                                      | 968            | 11             | 0.6            | STRW 050 090 10 XXX |                     |                  |
| 15                 | 521                 | 687       | 768                                      | 1561           | 13             | 0.9            | STRW 050 090 15 XXX |                     |                  |
| 20                 | 729                 | 961       | 1074                                     | 2183           | 15             | 1.2            | STRW 050 090 20 XXX |                     |                  |
| 100                | ---                 | ---       | ---                                      | ---            | ---            | ---            | ---                 |                     |                  |
| 10                 | 356                 | 471       | 526                                      | 1076           | 12             | 0.7            | STRW 050 100 10 XXX |                     |                  |
| 15                 | 579                 | 764       | 853                                      | 1734           | 14             | 1.0            | STRW 050 100 15 XXX |                     |                  |
| 20                 | 809                 | 1068      | 1193                                     | 2425           | 16             | 1.3            | STRW 050 100 20 XXX |                     |                  |
| 110                | ---                 | ---       | ---                                      | ---            | ---            | ---            | ---                 |                     |                  |
| 10                 | 391                 | 518       | 579                                      | 1184           | 12             | 0.7            | STRW 050 110 10 XXX |                     |                  |
| 15                 | 636                 | 840       | 938                                      | 1907           | 15             | 1.1            | STRW 050 110 15 XXX |                     |                  |
| 20                 | 890                 | 1175      | 1312                                     | 2668           | 18             | 1.5            | STRW 050 110 20 XXX |                     |                  |
| 120                | ---                 | ---       | ---                                      | ---            | ---            | ---            | ---                 |                     |                  |
| 10                 | 427                 | 565       | 631                                      | 1291           | 13             | 0.8            | STRW 050 120 10 XXX |                     |                  |
| 15                 | 694                 | 917       | 1023                                     | 2081           | 16             | 1.2            | STRW 050 120 15 XXX |                     |                  |
| 20                 | 971                 | 1282      | 1431                                     | 2910           | 19             | 1.6            | STRW 050 120 20 XXX |                     |                  |
| 140                | ---                 | ---       | ---                                      | ---            | ---            | ---            | ---                 |                     |                  |
| 10                 | 498                 | 659       | 736                                      | 1506           | 16             | 0.8            | STRW 050 140 10 XXX |                     |                  |
| 15                 | 810                 | 1069      | 1194                                     | 2428           | 19             | 1.2            | STRW 050 140 15 XXX |                     |                  |
| 20                 | 1133                | 1495      | 1670                                     | 3395           | 22             | 1.6            | STRW 050 140 20 XXX |                     |                  |
| 160                | ---                 | ---       | ---                                      | ---            | ---            | ---            | ---                 |                     |                  |
| 10                 | 569                 | 753       | 842                                      | 1722           | 18             | 1.0            | STRW 050 160 10 XXX |                     |                  |
| 15                 | 926                 | 1222      | 1364                                     | 2774           | 21             | 1.6            | STRW 050 160 15 XXX |                     |                  |
| 20                 | 1295                | 1709      | 1908                                     | 3880           | 25             | 2.1            | STRW 050 160 20 XXX |                     |                  |
| 180                | ---                 | ---       | ---                                      | ---            | ---            | ---            | ---                 |                     |                  |
| 10                 | 640                 | 847       | 947                                      | 1937           | 20             | 1.2            | STRW 050 180 10 XXX |                     |                  |
| 15                 | 1042                | 1375      | 1535                                     | 3121           | 23             | 1.8            | STRW 050 180 15 XXX |                     |                  |
| 20                 | 1457                | 1922      | 2147                                     | 4365           | 27             | 2.4            | STRW 050 180 20 XXX |                     |                  |
| 200                | ---                 | ---       | ---                                      | ---            | ---            | ---            | ---                 |                     |                  |
| 10                 | 711                 | 941       | 1052                                     | 2152           | 21             | 1.3            | STRW 050 200 10 XXX |                     |                  |
| 15                 | 1157                | 1527      | 1706                                     | 3468           | 26             | 2.0            | STRW 050 200 15 XXX |                     |                  |
| 20                 | 1619                | 2136      | 2385                                     | 4850           | 30             | 2.6            | STRW 050 200 20 XXX |                     |                  |
| 220                | ---                 | ---       | ---                                      | ---            | ---            | ---            | ---                 |                     |                  |
| 10                 | 782                 | 1035      | 1157                                     | 2367           | 1.4            | ---            | STRW 050 220 10 XXX |                     |                  |
| 15                 | 1273                | 1680      | 1876                                     | 3815           | 2.2            | ---            | STRW 050 220 15 XXX |                     |                  |
| 20                 | 1780                | 2350      | 2624                                     | 5335           | 2.9            | ---            | STRW 050 220 20 XXX |                     |                  |
| 240                | ---                 | ---       | ---                                      | ---            | ---            | ---            | ---                 |                     |                  |
| 10                 | 853                 | 1129      | 1262                                     | 2582           | 26             | 1.6            | STRW 050 240 10 XXX |                     |                  |
| 15                 | 1389                | 1833      | 2047                                     | 4162           | 31             | 2.4            | STRW 050 240 15 XXX |                     |                  |
| 20                 | 1942                | 2563      | 2862                                     | 5820           | 36             | 3.2            | STRW 050 240 20 XXX |                     |                  |
| 260                | ---                 | ---       | ---                                      | ---            | ---            | ---            | ---                 |                     |                  |
| 10                 | 925                 | 1223      | 1368                                     | 2798           | 1.7            | ---            | STRW 050 260 10 XXX |                     |                  |
| 15                 | 1504                | 1985      | 2217                                     | 4508           | 2.5            | ---            | STRW 050 260 15 XXX |                     |                  |
| 20                 | 2104                | 2777      | 3101                                     | 6305           | 3.4            | ---            | STRW 050 260 20 XXX |                     |                  |
| 280                | ---                 | ---       | ---                                      | ---            | ---            | ---            | ---                 |                     |                  |
| 10                 | 996                 | 1318      | 1473                                     | 3013           | 29             | 1.8            | STRW 050 280 10 XXX |                     |                  |
| 15                 | 1620                | 2138      | 2388                                     | 4855           | 35             | 2.7            | STRW 050 280 15 XXX |                     |                  |
| 20                 | 2266                | 2990      | 3339                                     | 6790           | 41             | 3.7            | STRW 050 280 20 XXX |                     |                  |

Emission EN442 à 20°C

remplir code de couleur

# STRADA HAUTEUR 050 (TWIN)

# TABLEAU TECHNIQUE

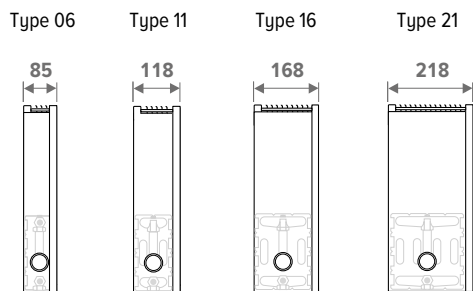

| HAUTEUR<br>H<br>cm | LONGUEUR<br>L<br>cm | TYPE<br>T | CHAUFFEUR<br>Temperature<br>ambiante 20°C |                |                |                | POIDS<br>kg | CONTENU EN EAU<br>L | CODE DE COMMANDE    |
|--------------------|---------------------|-----------|---|----------------|----------------|----------------|-------------|---------------------|---------------------|
|                    |                     |           | 45/40<br>Watts                            | 50/45<br>Watts | 55/45<br>Watts | 75/65<br>Watts |             |                     |                     |
| <b>STRW 050</b>    | <b>050</b>          | <b>06</b> | 158                                       | 209            | 233            | 474            | 6           | 0.3                 | STRW 050 050 06 XXX |
|                    |                     | <b>11</b> | 220                                       | 294            | 330            | 693            | 8           | 0.7                 | STRW 050 050 11 XXX |
|                    |                     | <b>16</b> | 294                                       | 396            | 445            | 949            | 10          | 1.0                 | STRW 050 050 16 XXX |
|                    |                     | <b>21</b> | 394                                       | 532            | 599            | 1291           | 11          | 1.3                 | STRW 050 050 21 XXX |
| <b>060</b>         | <b>06</b>           | <b>06</b> | 190                                       | 250            | 279            | 568            | 7           | 0.4                 | STRW 050 060 06 XXX |
|                    |                     | <b>11</b> | 264                                       | 352            | 396            | 832            | 9           | 0.8                 | STRW 050 060 11 XXX |
|                    |                     | <b>16</b> | 353                                       | 475            | 534            | 1139           | 11          | 1.2                 | STRW 050 060 16 XXX |
|                    |                     | <b>21</b> | 473                                       | 638            | 719            | 1549           | 13          | 1.6                 | STRW 050 060 21 XXX |
| <b>070</b>         | <b>06</b>           | <b>06</b> | 221                                       | 292            | 326            | 663            | 8           | 0.4                 | STRW 050 070 06 XXX |
|                    |                     | <b>11</b> | 307                                       | 411            | 461            | 970            | 10          | 0.9                 | STRW 050 070 11 XXX |
|                    |                     | <b>16</b> | 412                                       | 554            | 624            | 1329           | 12          | 1.4                 | STRW 050 070 16 XXX |
|                    |                     | <b>21</b> | 551                                       | 744            | 839            | 1807           | 14          | 1.9                 | STRW 050 070 21 XXX |
| <b>080</b>         | <b>06</b>           | <b>06</b> | 253                                       | 334            | 373            | 758            | 9           | 0.5                 | STRW 050 080 06 XXX |
|                    |                     | <b>11</b> | 351                                       | 470            | 527            | 1109           | 11          | 1.1                 | STRW 050 080 11 XXX |
|                    |                     | <b>16</b> | 471                                       | 633            | 712            | 1518           | 13          | 1.6                 | STRW 050 080 16 XXX |
|                    |                     | <b>21</b> | 630                                       | 851            | 959            | 2066           | 16          | 2.1                 | STRW 050 080 21 XXX |
| <b>090</b>         | <b>06</b>           | <b>06</b> | 285                                       | 375            | 419            | 852            | 10          | 0.6                 | STRW 050 090 06 XXX |
|                    |                     | <b>11</b> | 395                                       | 528            | 593            | 1247           | 12          | 1.2                 | STRW 050 090 11 XXX |
|                    |                     | <b>16</b> | 530                                       | 712            | 801            | 1708           | 15          | 1.8                 | STRW 050 090 16 XXX |
|                    |                     | <b>21</b> | 709                                       | 957            | 1079           | 2324           | 18          | 2.4                 | STRW 050 090 21 XXX |
| <b>100</b>         | <b>06</b>           | <b>06</b> | 316                                       | 417            | 466            | 947            | 11          | 0.6                 | STRW 050 100 06 XXX |
|                    |                     | <b>11</b> | 439                                       | 587            | 659            | 1386           | 13          | 1.3                 | STRW 050 100 11 XXX |
|                    |                     | <b>16</b> | 589                                       | 792            | 891            | 1898           | 16          | 2.0                 | STRW 050 100 16 XXX |
|                    |                     | <b>21</b> | 788                                       | 1064           | 1198           | 2582           | 19          | 2.7                 | STRW 050 100 21 XXX |
| <b>110</b>         | <b>06</b>           | <b>06</b> | 348                                       | 459            | 513            | 1042           | 12          | 0.7                 | STRW 050 110 06 XXX |
|                    |                     | <b>11</b> | 483                                       | 646            | 725            | 1525           | 14          | 1.5                 | STRW 050 110 11 XXX |
|                    |                     | <b>16</b> | 648                                       | 871            | 980            | 2088           | 17          | 2.2                 | STRW 050 110 16 XXX |
|                    |                     | <b>21</b> | 867                                       | 1170           | 1318           | 2840           | 21          | 2.9                 | STRW 050 110 21 XXX |
| <b>120</b>         | <b>06</b>           | <b>06</b> | 379                                       | 501            | 559            | 1136           | 13          | 0.8                 | STRW 050 120 06 XXX |
|                    |                     | <b>11</b> | 527                                       | 705            | 791            | 1663           | 15          | 1.6                 | STRW 050 120 11 XXX |
|                    |                     | <b>16</b> | 707                                       | 950            | 1069           | 2278           | 19          | 2.4                 | STRW 050 120 16 XXX |
|                    |                     | <b>21</b> | 945                                       | 1276           | 1438           | 3098           | 22          | 3.2                 | STRW 050 120 21 XXX |
| <b>140</b>         | <b>06</b>           | <b>06</b> | 443                                       | 584            | 652            | 1326           | 15          | 0.8                 | STRW 050 140 06 XXX |
|                    |                     | <b>11</b> | 615                                       | 822            | 923            | 1940           | 18          | 1.6                 | STRW 050 140 11 XXX |
|                    |                     | <b>16</b> | 825                                       | 1108           | 1247           | 2657           | 23          | 2.4                 | STRW 050 140 16 XXX |
|                    |                     | <b>21</b> | 1103                                      | 1489           | 1678           | 3615           | 27          | 3.2                 | STRW 050 140 21 XXX |
| <b>160</b>         | <b>06</b>           | <b>06</b> | 506                                       | 668            | 745            | 1515           | 16          | 1.0                 | STRW 050 160 06 XXX |
|                    |                     | <b>11</b> | 703                                       | 940            | 1055           | 2218           | 20          | 2.1                 | STRW 050 160 11 XXX |
|                    |                     | <b>16</b> | 942                                       | 1267           | 1425           | 3037           | 25          | 3.2                 | STRW 050 160 16 XXX |
|                    |                     | <b>21</b> | 1261                                      | 1702           | 1917           | 4131           | 29          | 4.3                 | STRW 050 160 21 XXX |
| <b>180</b>         | <b>06</b>           | <b>06</b> | 569                                       | 751            | 839            | 1705           | 18          | 1.2                 | STRW 050 180 06 XXX |
|                    |                     | <b>11</b> | 790                                       | 1057           | 1187           | 2495           | 22          | 2.4                 | STRW 050 180 11 XXX |
|                    |                     | <b>16</b> | 1060                                      | 1425           | 1603           | 3416           | 27          | 3.6                 | STRW 050 180 16 XXX |
|                    |                     | <b>21</b> | 1418                                      | 1915           | 2157           | 4648           | 32          | 4.8                 | STRW 050 180 21 XXX |
| <b>200</b>         | <b>06</b>           | <b>06</b> | 633                                       | 835            | 932            | 1894           | 20          | 1.3                 | STRW 050 200 06 XXX |
|                    |                     | <b>11</b> | 878                                       | 1174           | 1318           | 2772           | 24          | 2.7                 | STRW 050 200 11 XXX |
|                    |                     | <b>16</b> | 1178                                      | 1583           | 1781           | 3796           | 29          | 4.0                 | STRW 050 200 16 XXX |
|                    |                     | <b>21</b> | 1576                                      | 2127           | 2397           | 5164           | 36          | 5.3                 | STRW 050 200 21 XXX |
| <b>220</b>         | <b>06</b>           | <b>06</b> | 691                                       | 914            | 1021           | 2083           | 1.4         | STRW 050 220 06 XXX |                     |
|                    |                     | <b>11</b> | 966                                       | 1292           | 1450           | 3049           | 2.9         | STRW 050 220 11 XXX |                     |
|                    |                     | <b>16</b> | 1296                                      | 1742           | 1959           | 4176           | 4.4         | STRW 050 220 16 XXX |                     |
|                    |                     | <b>21</b> | 1733                                      | 2340           | 2636           | 5680           | 5.9         | STRW 050 220 21 XXX |                     |
| <b>240</b>         | <b>06</b>           | <b>06</b> | 759                                       | 1002           | 1118           | 2273           | 24          | 1.5                 | STRW 050 240 06 XXX |
|                    |                     | <b>11</b> | 1054                                      | 1409           | 1582           | 3326           | 29          | 3.2                 | STRW 050 240 11 XXX |
|                    |                     | <b>16</b> | 1413                                      | 1900           | 2137           | 4555           | 35          | 4.8                 | STRW 050 240 16 XXX |
|                    |                     | <b>21</b> | 1891                                      | 2553           | 2876           | 6197           | 42          | 6.4                 | STRW 050 240 21 XXX |
| <b>260</b>         | <b>06</b>           | <b>06</b> | 817                                       | 1080           | 1206           | 2462           | 1.7         | STRW 050 260 06 XXX |                     |
|                    |                     | <b>11</b> | 1142                                      | 1527           | 1714           | 3604           | 3.5         | STRW 050 260 11 XXX |                     |
|                    |                     | <b>16</b> | 1531                                      | 2058           | 2316           | 4935           | 5.1         | STRW 050 260 16 XXX |                     |
|                    |                     | <b>21</b> | 2048                                      | 2765           | 3116           | 6713           | 6.9         | STRW 050 260 21 XXX |                     |
| <b>280</b>         | <b>06</b>           | <b>06</b> | 886                                       | 1169           | 1305           | 2652           | 28          | 1.8                 | STRW 050 280 06 XXX |
|                    |                     | <b>11</b> | 1230                                      | 1644           | 1846           | 3881           | 34          | 3.7                 | STRW 050 280 11 XXX |
|                    |                     | <b>16</b> | 1649                                      | 2217           | 2493           | 5314           | 40          | 5.5                 | STRW 050 280 16 XXX |
|                    |                     | <b>21</b> | 2206                                      | 2978           | 3356           | 7230           | 49          | 7.4                 | STRW 050 280 21 XXX |

Émission EN442 à 20°C

remplir code de couleur

# STRADA HAUTEUR 065 (STANDARD)

# TABLEAU TECHNIQUE

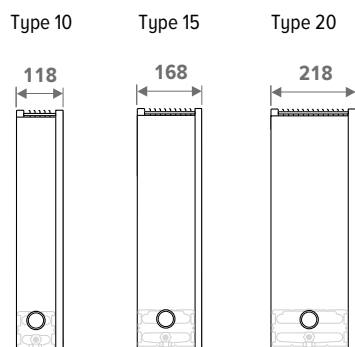

| HAUTEUR<br>H<br>cm | LONGUEUR<br>L<br>cm | TYPE<br>T | CHAUFFER<br>Température<br>ambiante 20°C |                |                |                | POIDS<br>kg | CONTENU EN EAU<br>L | CODE DE COMMANDE    |
|--------------------|---------------------|-----------|--|----------------|----------------|----------------|-------------|---------------------|---------------------|
|                    |                     |           | 45/40<br>Watts                           | 50/45<br>Watts | 55/45<br>Watts | 75/65<br>Watts |             |                     |                     |
| STRW 065           | 050                 | ---       | ---                                      | ---            | ---            | ---            | ---         | ---                 |                     |
|                    |                     | 10        | 203                                      | 267            | 298            | 606            | 8           | 0.3                 | STRW 065 050 10 XXX |
|                    |                     | 15        | 325                                      | 428            | 477            | 961            | 10          | 0.5                 | STRW 065 050 15 XXX |
|                    | 20                  | 455       | 598                                      | 667            | 1343           | 12             | 0.7         | STRW 065 050 20 XXX |                     |
| 060                | ---                 | ---       | ---                                      | ---            | ---            | ---            | ---         | ---                 |                     |
|                    | 10                  | 243       | 321                                      | 358            | 727            | 10             | 0.4         | STRW 065 060 10 XXX |                     |
|                    | 15                  | 390       | 513                                      | 572            | 1153           | 11             | 0.6         | STRW 065 060 15 XXX |                     |
|                    | 20                  | 545       | 717                                      | 800            | 1611           | 13             | 0.8         | STRW 065 060 20 XXX |                     |
| 070                | ---                 | ---       | ---                                      | ---            | ---            | ---            | ---         | ---                 |                     |
|                    | 10                  | 283       | 374                                      | 417            | 848            | 11             | 0.5         | STRW 065 070 10 XXX |                     |
|                    | 15                  | 455       | 599                                      | 668            | 1345           | 13             | 0.7         | STRW 065 070 15 XXX |                     |
|                    | 20                  | 636       | 837                                      | 933            | 1880           | 15             | 0.9         | STRW 065 070 20 XXX |                     |
| 080                | ---                 | ---       | ---                                      | ---            | ---            | ---            | ---         | ---                 |                     |
|                    | 10                  | 324       | 427                                      | 477            | 969            | 12             | 0.5         | STRW 065 080 10 XXX |                     |
|                    | 15                  | 521       | 685                                      | 763            | 1538           | 14             | 0.8         | STRW 065 080 15 XXX |                     |
|                    | 20                  | 727       | 956                                      | 1066           | 2148           | 16             | 1.1         | STRW 065 080 20 XXX |                     |
| 090                | ---                 | ---       | ---                                      | ---            | ---            | ---            | ---         | ---                 |                     |
|                    | 10                  | 364       | 481                                      | 537            | 1090           | 13             | 0.6         | STRW 065 090 10 XXX |                     |
|                    | 15                  | 586       | 770                                      | 859            | 1730           | 15             | 0.9         | STRW 065 090 15 XXX |                     |
|                    | 20                  | 818       | 1076                                     | 1200           | 2417           | 18             | 1.2         | STRW 065 090 20 XXX |                     |
| 100                | ---                 | ---       | ---                                      | ---            | ---            | ---            | ---         | ---                 |                     |
|                    | 10                  | 405       | 534                                      | 596            | 1211           | 14             | 0.7         | STRW 065 100 10 XXX |                     |
|                    | 15                  | 651       | 856                                      | 954            | 1922           | 16             | 1.0         | STRW 065 100 15 XXX |                     |
|                    | 20                  | 909       | 1195                                     | 1333           | 2685           | 19             | 1.3         | STRW 065 100 20 XXX |                     |
| 110                | ---                 | ---       | ---                                      | ---            | ---            | ---            | ---         | ---                 |                     |
|                    | 10                  | 445       | 587                                      | 656            | 1332           | 15             | 0.7         | STRW 065 110 10 XXX |                     |
|                    | 15                  | 716       | 941                                      | 1049           | 2114           | 18             | 1.1         | STRW 065 110 15 XXX |                     |
|                    | 20                  | 1000      | 1315                                     | 1466           | 2954           | 20             | 1.5         | STRW 065 110 20 XXX |                     |
| 120                | ---                 | ---       | ---                                      | ---            | ---            | ---            | ---         | ---                 |                     |
|                    | 10                  | 486       | 641                                      | 715            | 1453           | 16             | 0.8         | STRW 065 120 10 XXX |                     |
|                    | 15                  | 781       | 1027                                     | 1145           | 2306           | 19             | 1.2         | STRW 065 120 15 XXX |                     |
|                    | 20                  | 1091      | 1434                                     | 1599           | 3222           | 22             | 1.6         | STRW 065 120 20 XXX |                     |
| 140                | ---                 | ---       | ---                                      | ---            | ---            | ---            | ---         | ---                 |                     |
|                    | 10                  | 567       | 747                                      | 835            | 1695           | 19             | 0.8         | STRW 065 140 10 XXX |                     |
|                    | 15                  | 911       | 1198                                     | 1336           | 2691           | 22             | 1.2         | STRW 065 140 15 XXX |                     |
|                    | 20                  | 1273      | 1673                                     | 1866           | 3759           | 26             | 1.6         | STRW 065 140 20 XXX |                     |
| 160                | ---                 | ---       | ---                                      | ---            | ---            | ---            | ---         | ---                 |                     |
|                    | 10                  | 648       | 855                                      | 954            | 1938           | 21             | 1.0         | STRW 065 160 10 XXX |                     |
|                    | 15                  | 1041      | 1369                                     | 1526           | 3075           | 25             | 1.6         | STRW 065 160 15 XXX |                     |
|                    | 20                  | 1454      | 1912                                     | 2133           | 4296           | 29             | 2.1         | STRW 065 160 20 XXX |                     |
| 180                | ---                 | ---       | ---                                      | ---            | ---            | ---            | ---         | ---                 |                     |
|                    | 10                  | 729       | 961                                      | 1073           | 2180           | 23             | 1.2         | STRW 065 180 10 XXX |                     |
|                    | 15                  | 1171      | 1540                                     | 1718           | 3460           | 27             | 1.8         | STRW 065 180 15 XXX |                     |
|                    | 20                  | 1636      | 2152                                     | 2399           | 4833           | 32             | 2.4         | STRW 065 180 20 XXX |                     |
| 200                | ---                 | ---       | ---                                      | ---            | ---            | ---            | ---         | ---                 |                     |
|                    | 10                  | 810       | 1068                                     | 1192           | 2422           | 25             | 1.3         | STRW 065 200 10 XXX |                     |
|                    | 15                  | 1301      | 1711                                     | 1908           | 3844           | 30             | 2.0         | STRW 065 200 15 XXX |                     |
|                    | 20                  | 1818      | 2391                                     | 2666           | 5370           | 34             | 2.6         | STRW 065 200 20 XXX |                     |
| 220                | ---                 | ---       | ---                                      | ---            | ---            | ---            | ---         | ---                 |                     |
|                    | 10                  | 922       | 1214                                     | 1355           | 2746           | 1.4            | ---         | STRW 065 220 10 XXX |                     |
|                    | 15                  | 1475      | 1937                                     | 2159           | 4338           | 2.2            | ---         | STRW 065 220 15 XXX |                     |
|                    | 20                  | 2061      | 2706                                     | 3016           | 6057           | 2.9            | ---         | STRW 065 220 20 XXX |                     |
| 240                | ---                 | ---       | ---                                      | ---            | ---            | ---            | ---         | ---                 |                     |
|                    | 10                  | 971       | 1281                                     | 1431           | 2906           | 31             | 1.6         | STRW 065 240 10 XXX |                     |
|                    | 15                  | 1562      | 2054                                     | 2290           | 4613           | 36             | 2.4         | STRW 065 240 15 XXX |                     |
|                    | 20                  | 2182      | 2869                                     | 3199           | 6444           | 41             | 3.2         | STRW 065 240 20 XXX |                     |
| 260                | ---                 | ---       | ---                                      | ---            | ---            | ---            | ---         | ---                 |                     |
|                    | 10                  | 1089      | 1435                                     | 1602           | 3245           | 1.7            | ---         | STRW 065 260 10 XXX |                     |
|                    | 15                  | 1743      | 2289                                     | 2552           | 5127           | 2.5            | ---         | STRW 065 260 15 XXX |                     |
|                    | 20                  | 2435      | 3198                                     | 3564           | 7158           | 3.4            | ---         | STRW 065 260 20 XXX |                     |
| 280                | ---                 | ---       | ---                                      | ---            | ---            | ---            | ---         | ---                 |                     |
|                    | 10                  | 1133      | 1495                                     | 1669           | 3391           | 35             | 1.8         | STRW 065 280 10 XXX |                     |
|                    | 15                  | 1822      | 2396                                     | 2672           | 5382           | 41             | 2.7         | STRW 065 280 15 XXX |                     |
|                    | 20                  | 2545      | 3347                                     | 3732           | 7518           | 47             | 3.7         | STRW 065 280 20 XXX |                     |

Emission EN442 à 20°C

remplir code de couleur

# STRADA HAUTEUR 065 (TWIN)

# TABLEAU TECHNIQUE

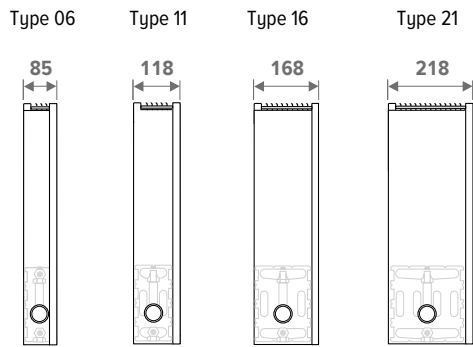

| HAUTEUR<br>H<br>cm | LONGUEUR<br>L<br>cm | TYPE<br>T | CHAUFFEUR<br>Température<br>ambiante 20°C |                |                |                | POIDS<br>kg | CONTENU EN EAU<br>L | CODE DE COMMANDE    |
|--------------------|---------------------|-----------|---|----------------|----------------|----------------|-------------|---------------------|---------------------|
|                    |                     |           | 45/40<br>Watts                            | 50/45<br>Watts | 55/45<br>Watts | 75/65<br>Watts |             |                     |                     |
| <b>STRW 065</b>    | <b>050</b>          | <b>06</b> | 181                                       | 238            | 265            | 533            | 8           | 0.3                 | STRW 065 050 06 XXX |
|                    |                     | <b>11</b> | 245                                       | 327            | 367            | 772            | 9           | 0.7                 | STRW 065 050 11 XXX |
|                    |                     | <b>16</b> | 336                                       | 452            | 508            | 1087           | 11          | 1.0                 | STRW 065 050 16 XXX |
|                    |                     | <b>21</b> | 458                                       | 620            | 699            | 1515           | 13          | 1.3                 | STRW 065 050 21 XXX |
|                    | <b>060</b>          | <b>06</b> | 218                                       | 286            | 319            | 640            | 9           | 0.4                 | STRW 065 060 06 XXX |
|                    |                     | <b>11</b> | 294                                       | 393            | 441            | 926            | 10          | 0.8                 | STRW 065 060 11 XXX |
|                    |                     | <b>16</b> | 403                                       | 542            | 610            | 1304           | 13          | 1.2                 | STRW 065 060 16 XXX |
|                    |                     | <b>21</b> | 549                                       | 744            | 839            | 1818           | 15          | 1.6                 | STRW 065 060 21 XXX |
|                    | <b>070</b>          | <b>06</b> | 254                                       | 333            | 371            | 746            | 10          | 0.4                 | STRW 065 070 06 XXX |
|                    |                     | <b>11</b> | 342                                       | 458            | 514            | 1080           | 12          | 0.9                 | STRW 065 070 11 XXX |
|                    |                     | <b>16</b> | 470                                       | 632            | 711            | 1521           | 14          | 1.4                 | STRW 065 070 16 XXX |
|                    |                     | <b>21</b> | 641                                       | 867            | 978            | 2121           | 16          | 1.9                 | STRW 065 070 21 XXX |
|                    | <b>080</b>          | <b>06</b> | 290                                       | 381            | 425            | 853            | 11          | 0.5                 | STRW 065 080 06 XXX |
|                    |                     | <b>11</b> | 391                                       | 523            | 587            | 1234           | 13          | 1.1                 | STRW 065 080 11 XXX |
|                    |                     | <b>16</b> | 537                                       | 722            | 813            | 1738           | 16          | 1.6                 | STRW 065 080 16 XXX |
|                    |                     | <b>21</b> | 733                                       | 991            | 1118           | 2424           | 18          | 2.1                 | STRW 065 080 21 XXX |
|                    | <b>090</b>          | <b>06</b> | 326                                       | 428            | 477            | 959            | 12          | 0.6                 | STRW 065 090 06 XXX |
|                    |                     | <b>11</b> | 440                                       | 589            | 661            | 1389           | 14          | 1.2                 | STRW 065 090 11 XXX |
|                    |                     | <b>16</b> | 604                                       | 813            | 915            | 1956           | 17          | 1.8                 | STRW 065 090 16 XXX |
|                    |                     | <b>21</b> | 824                                       | 1115           | 1258           | 2727           | 20          | 2.4                 | STRW 065 090 21 XXX |
|                    | <b>100</b>          | <b>06</b> | 362                                       | 476            | 531            | 1066           | 13          | 0.6                 | STRW 065 100 06 XXX |
|                    |                     | <b>11</b> | 489                                       | 654            | 734            | 1543           | 15          | 1.3                 | STRW 065 100 11 XXX |
|                    |                     | <b>16</b> | 671                                       | 903            | 1016           | 2173           | 19          | 2.0                 | STRW 065 100 16 XXX |
|                    |                     | <b>21</b> | 916                                       | 1239           | 1398           | 3030           | 22          | 2.7                 | STRW 065 100 21 XXX |
|                    | <b>110</b>          | <b>06</b> | 399                                       | 524            | 584            | 1173           | 14          | 0.7                 | STRW 065 110 06 XXX |
|                    |                     | <b>11</b> | 538                                       | 719            | 807            | 1697           | 17          | 1.5                 | STRW 065 110 11 XXX |
|                    |                     | <b>16</b> | 738                                       | 993            | 1118           | 2390           | 20          | 2.2                 | STRW 065 110 16 XXX |
|                    |                     | <b>21</b> | 1007                                      | 1363           | 1537           | 3333           | 23          | 2.9                 | STRW 065 110 21 XXX |
|                    | <b>120</b>          | <b>06</b> | 435                                       | 571            | 637            | 1279           | 15          | 0.8                 | STRW 065 120 06 XXX |
|                    |                     | <b>11</b> | 587                                       | 785            | 881            | 1852           | 18          | 1.6                 | STRW 065 120 11 XXX |
|                    |                     | <b>16</b> | 805                                       | 1084           | 1220           | 2608           | 22          | 2.4                 | STRW 065 120 16 XXX |
|                    |                     | <b>21</b> | 1099                                      | 1487           | 1677           | 3636           | 25          | 3.2                 | STRW 065 120 21 XXX |
|                    | <b>140</b>          | <b>06</b> | 507                                       | 666            | 743            | 1492           | 18          | 0.8                 | STRW 065 140 06 XXX |
|                    |                     | <b>11</b> | 685                                       | 916            | 1028           | 2160           | 21          | 1.6                 | STRW 065 140 11 XXX |
|                    |                     | <b>16</b> | 939                                       | 1264           | 1423           | 3042           | 26          | 2.4                 | STRW 065 140 16 XXX |
|                    |                     | <b>21</b> | 1282                                      | 1735           | 1957           | 4242           | 31          | 3.2                 | STRW 065 140 21 XXX |
|                    | <b>160</b>          | <b>06</b> | 580                                       | 762            | 849            | 1706           | 20          | 1.0                 | STRW 065 160 06 XXX |
|                    |                     | <b>11</b> | 783                                       | 1047           | 1175           | 2469           | 24          | 2.1                 | STRW 065 160 11 XXX |
|                    |                     | <b>16</b> | 1074                                      | 1445           | 1626           | 3477           | 28          | 3.2                 | STRW 065 160 16 XXX |
|                    |                     | <b>21</b> | 1465                                      | 1983           | 2236           | 4848           | 33          | 4.3                 | STRW 065 160 21 XXX |
|                    | <b>180</b>          | <b>06</b> | 652                                       | 857            | 955            | 1919           | 22          | 1.2                 | STRW 065 180 06 XXX |
|                    |                     | <b>11</b> | 881                                       | 1177           | 1321           | 2777           | 26          | 2.4                 | STRW 065 180 11 XXX |
|                    |                     | <b>16</b> | 1208                                      | 1626           | 1829           | 3911           | 31          | 3.6                 | STRW 065 180 16 XXX |
|                    |                     | <b>21</b> | 1648                                      | 2231           | 2516           | 5454           | 37          | 4.8                 | STRW 065 180 21 XXX |
|                    | <b>200</b>          | <b>06</b> | 725                                       | 952            | 1061           | 2132           | 24          | 1.3                 | STRW 065 200 06 XXX |
|                    |                     | <b>11</b> | 979                                       | 1308           | 1468           | 3086           | 29          | 2.7                 | STRW 065 200 11 XXX |
|                    |                     | <b>16</b> | 1342                                      | 1806           | 2033           | 4346           | 34          | 4.0                 | STRW 065 200 16 XXX |
|                    |                     | <b>21</b> | 1832                                      | 2478           | 2795           | 6060           | 40          | 5.3                 | STRW 065 200 21 XXX |
|                    | <b>220</b>          | <b>06</b> | 766                                       | 1016           | 1137           | 2345           | 1.4         |                     | STRW 065 220 06 XXX |
|                    |                     | <b>11</b> | 1110                                      | 1484           | 1665           | 3498           | 2.9         |                     | STRW 065 220 11 XXX |
|                    |                     | <b>16</b> | 1533                                      | 2064           | 2323           | 4972           | 4.4         |                     | STRW 065 220 16 XXX |
|                    |                     | <b>21</b> | 2106                                      | 2852           | 3217           | 6989           | 5.9         |                     | STRW 065 220 21 XXX |
|                    | <b>240</b>          | <b>06</b> | 870                                       | 1142           | 1273           | 2558           | 29          | 1.5                 | STRW 065 240 06 XXX |
|                    |                     | <b>11</b> | 1174                                      | 1570           | 1762           | 3703           | 34          | 3.2                 | STRW 065 240 11 XXX |
|                    |                     | <b>16</b> | 1611                                      | 2168           | 2439           | 5215           | 40          | 4.8                 | STRW 065 240 16 XXX |
|                    |                     | <b>21</b> | 2198                                      | 2974           | 3355           | 7272           | 48          | 6.4                 | STRW 065 240 21 XXX |
|                    | <b>260</b>          | <b>06</b> | 905                                       | 1201           | 1344           | 2772           | 1.7         |                     | STRW 065 260 06 XXX |
|                    |                     | <b>11</b> | 1312                                      | 1753           | 1968           | 4134           | 3.5         |                     | STRW 065 260 11 XXX |
|                    |                     | <b>16</b> | 1812                                      | 2439           | 2746           | 5876           | 5.1         |                     | STRW 065 260 16 XXX |
|                    |                     | <b>21</b> | 2488                                      | 3370           | 3802           | 8260           | 6.9         |                     | STRW 065 260 21 XXX |
|                    | <b>280</b>          | <b>06</b> | 1015                                      | 1333           | 1486           | 2985           | 33          | 1.8                 | STRW 065 280 06 XXX |
|                    |                     | <b>11</b> | 1370                                      | 1831           | 2056           | 4320           | 39          | 3.7                 | STRW 065 280 11 XXX |
|                    |                     | <b>16</b> | 1879                                      | 2529           | 2846           | 6084           | 46          | 5.5                 | STRW 065 280 16 XXX |
|                    |                     | <b>21</b> | 2564                                      | 3470           | 3914           | 8484           | 55          | 7.4                 | STRW 065 280 21 XXX |

Émission EN442 à 20°C

remplir code de couleur

# STRADA HAUTEUR 095 (STANDARD)

# TABLEAU TECHNIQUE

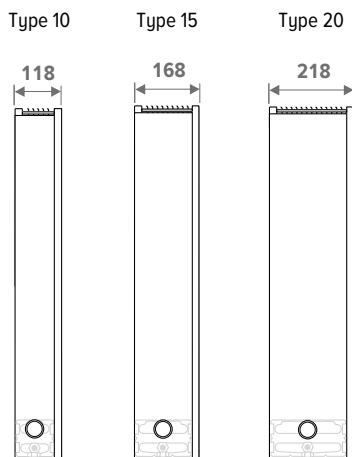

| HAUTEUR<br>H<br>cm | LONGUEUR<br>L<br>cm | TYPE<br>T | CHAUFFER<br>Temperature<br>ambiante 20°C |                |                |                | POIDS<br>kg | CONTENU EN EAU<br>L | CODE DE COMMANDE    |
|--------------------|---------------------|-----------|--|----------------|----------------|----------------|-------------|---------------------|---------------------|
|                    |                     |           | 45/40<br>Watts                           | 50/45<br>Watts | 55/45<br>Watts | 75/65<br>Watts |             |                     |                     |
| STRW 095           | 050                 | ---       | ---                                      | ---            | ---            | ---            | ---         | ---                 | ---                 |
|                    |                     | 10        | ---                                      | ---            | ---            | ---            | ---         | ---                 | ---                 |
|                    |                     | 15        | ---                                      | ---            | ---            | ---            | ---         | ---                 | ---                 |
|                    |                     | 20        | ---                                      | ---            | ---            | ---            | ---         | ---                 | ---                 |
|                    | 060                 | ---       | ---                                      | ---            | ---            | ---            | ---         | ---                 | ---                 |
|                    |                     | 10        | 286                                      | 375            | 418            | 836            | 14          | 0.4                 | STRW 095 060 10 XXX |
|                    |                     | 15        | 448                                      | 586            | 651            | 1288           | 17          | 0.6                 | STRW 095 060 15 XXX |
|                    |                     | 20        | 625                                      | 816            | 907            | 1795           | 19          | 0.8                 | STRW 095 060 20 XXX |
|                    | 070                 | ---       | ---                                      | ---            | ---            | ---            | ---         | ---                 | ---                 |
|                    |                     | 10        | 333                                      | 437            | 487            | 975            | 16          | 0.5                 | STRW 095 070 10 XXX |
|                    |                     | 15        | 523                                      | 683            | 759            | 1502           | 18          | 0.7                 | STRW 095 070 15 XXX |
|                    |                     | 20        | 729                                      | 952            | 1058           | 2094           | 21          | 0.9                 | STRW 095 070 20 XXX |
| 080                | ---                 | ---       | ---                                      | ---            | ---            | ---            | ---         | ---                 |                     |
|                    | 10                  | 381       | 499                                      | 556            | 1114           | 17             | 0.5         | STRW 095 080 10 XXX |                     |
|                    | 15                  | 598       | 781                                      | 868            | 1717           | 20             | 0.8         | STRW 095 080 15 XXX |                     |
|                    | 20                  | 834       | 1088                                     | 1210           | 2394           | 23             | 1.1         | STRW 095 080 20 XXX |                     |
| 090                | ---                 | ---       | ---                                      | ---            | ---            | ---            | ---         | ---                 |                     |
|                    | 10                  | 429       | 562                                      | 626            | 1254           | 18             | 0.6         | STRW 095 090 10 XXX |                     |
|                    | 15                  | 672       | 878                                      | 976            | 1931           | 21             | 0.9         | STRW 095 090 15 XXX |                     |
|                    | 20                  | 938       | 1224                                     | 1361           | 2693           | 24             | 1.2         | STRW 095 090 20 XXX |                     |
| 100                | ---                 | ---       | ---                                      | ---            | ---            | ---            | ---         | ---                 |                     |
|                    | 10                  | 476       | 625                                      | 696            | 1393           | 20             | 0.7         | STRW 095 100 10 XXX |                     |
|                    | 15                  | 747       | 976                                      | 1085           | 2146           | 23             | 1.0         | STRW 095 100 15 XXX |                     |
|                    | 20                  | 1042      | 1360                                     | 1512           | 2992           | 26             | 1.3         | STRW 095 100 20 XXX |                     |
| 110                | ---                 | ---       | ---                                      | ---            | ---            | ---            | ---         | ---                 |                     |
|                    | 10                  | 524       | 687                                      | 765            | 1532           | 21             | 0.7         | STRW 095 110 10 XXX |                     |
|                    | 15                  | 822       | 1073                                     | 1193           | 2361           | 25             | 1.1         | STRW 095 110 15 XXX |                     |
|                    | 20                  | 1146      | 1496                                     | 1664           | 3291           | 28             | 1.5         | STRW 095 110 20 XXX |                     |
| 120                | ---                 | ---       | ---                                      | ---            | ---            | ---            | ---         | ---                 |                     |
|                    | 10                  | 572       | 750                                      | 835            | 1672           | 25             | 0.8         | STRW 095 120 10 XXX |                     |
|                    | 15                  | 897       | 1171                                     | 1302           | 2575           | 29             | 1.2         | STRW 095 120 15 XXX |                     |
|                    | 20                  | 1250      | 1632                                     | 1815           | 3590           | 33             | 1.6         | STRW 095 120 20 XXX |                     |
| 140                | ---                 | ---       | ---                                      | ---            | ---            | ---            | ---         | ---                 |                     |
|                    | 10                  | 667       | 874                                      | 974            | 1950           | 25             | 0.8         | STRW 095 140 10 XXX |                     |
|                    | 15                  | 1046      | 1366                                     | 1518           | 3004           | 29             | 1.2         | STRW 095 140 15 XXX |                     |
|                    | 20                  | 1458      | 1904                                     | 2117           | 4189           | 33             | 1.6         | STRW 095 140 20 XXX |                     |

Émission EN442 à 20°C

remplir code de couleur



# STRADA HAUTEUR 095 (TWIN)

# TABLEAU TECHNIQUE

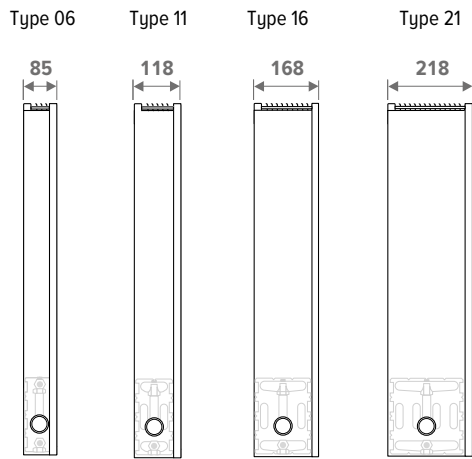

| HAUTEUR<br>H<br>cm | LONGUEUR<br>L<br>cm | TYPE<br>T | CHAUFFEUR<br>Température<br>ambiante 20°C |                |                |                | POIDS<br>kg | CONTENU EN EAU<br>L | CODE DE COMMANDE    |
|--------------------|---------------------|-----------|---|----------------|----------------|----------------|-------------|---------------------|---------------------|
|                    |                     |           | 45/40<br>Watts                            | 50/45<br>Watts | 55/45<br>Watts | 75/65<br>Watts |             |                     |                     |
| STRW 095           | 050                 | 06        | ---                                       | ---            | ---            | ---            | ---         | ---                 | ---                 |
|                    |                     | 11        | ---                                       | ---            | ---            | ---            | ---         | ---                 | ---                 |
|                    |                     | 16        | ---                                       | ---            | ---            | ---            | ---         | ---                 | ---                 |
|                    |                     | 21        | ---                                       | ---            | ---            | ---            | ---         | ---                 | ---                 |
| 060                | 06                  | 06        | 259                                       | 337            | 375            | 736            | 12          | 0.4                 | STRW 095 060 06 XXX |
|                    |                     | 11        | 343                                       | 458            | 514            | 1078           | 14          | 0.8                 | STRW 095 060 11 XXX |
|                    |                     | 16        | 491                                       | 663            | 747            | 1606           | 16          | 1.2                 | STRW 095 060 16 XXX |
|                    |                     | 21        | 697                                       | 948            | 1071           | 2352           | 19          | 1.6                 | STRW 095 060 21 XXX |
| 070                | 06                  | 06        | 302                                       | 393            | 437            | 858            | 13          | 0.4                 | STRW 095 070 06 XXX |
|                    |                     | 11        | 400                                       | 534            | 599            | 1257           | 15          | 0.9                 | STRW 095 070 11 XXX |
|                    |                     | 16        | 573                                       | 773            | 871            | 1874           | 18          | 1.4                 | STRW 095 070 16 XXX |
|                    |                     | 21        | 813                                       | 1106           | 1250           | 2744           | 21          | 1.9                 | STRW 095 070 21 XXX |
| 080                | 06                  | 06        | 345                                       | 449            | 499            | 981            | 14          | 0.5                 | STRW 095 080 06 XXX |
|                    |                     | 11        | 457                                       | 610            | 685            | 1437           | 17          | 1.1                 | STRW 095 080 11 XXX |
|                    |                     | 16        | 655                                       | 884            | 996            | 2142           | 20          | 1.6                 | STRW 095 080 16 XXX |
|                    |                     | 21        | 929                                       | 1264           | 1428           | 3136           | 23          | 2.1                 | STRW 095 080 21 XXX |
| 090                | 06                  | 06        | 388                                       | 505            | 561            | 1103           | 16          | 0.6                 | STRW 095 090 06 XXX |
|                    |                     | 11        | 514                                       | 686            | 770            | 1616           | 18          | 1.2                 | STRW 095 090 11 XXX |
|                    |                     | 16        | 737                                       | 994            | 1120           | 2409           | 22          | 1.8                 | STRW 095 090 16 XXX |
|                    |                     | 21        | 1045                                      | 1421           | 1607           | 3528           | 25          | 2.4                 | STRW 095 090 21 XXX |
| 100                | 06                  | 06        | 431                                       | 562            | 624            | 1226           | 17          | 0.6                 | STRW 095 100 06 XXX |
|                    |                     | 11        | 571                                       | 763            | 856            | 1796           | 20          | 1.3                 | STRW 095 100 11 XXX |
|                    |                     | 16        | 819                                       | 1105           | 1244           | 2677           | 24          | 2.0                 | STRW 095 100 16 XXX |
|                    |                     | 21        | 1161                                      | 1579           | 1785           | 3920           | 27          | 2.7                 | STRW 095 100 21 XXX |
| 110                | 06                  | 06        | 475                                       | 618            | 686            | 1349           | 18          | 0.7                 | STRW 095 110 06 XXX |
|                    |                     | 11        | 628                                       | 839            | 942            | 1976           | 22          | 1.5                 | STRW 095 110 11 XXX |
|                    |                     | 16        | 901                                       | 1215           | 1369           | 2945           | 25          | 2.2                 | STRW 095 110 16 XXX |
|                    |                     | 21        | 1277                                      | 1737           | 1964           | 4312           | 29          | 2.9                 | STRW 095 110 21 XXX |
| 120                | 06                  | 06        | 518                                       | 674            | 749            | 1471           | 20          | 0.8                 | STRW 095 120 06 XXX |
|                    |                     | 11        | 685                                       | 915            | 1027           | 2155           | 23          | 1.6                 | STRW 095 120 11 XXX |
|                    |                     | 16        | 982                                       | 1325           | 1493           | 3212           | 27          | 2.4                 | STRW 095 120 16 XXX |
|                    |                     | 21        | 1394                                      | 1895           | 2142           | 4704           | 31          | 3.2                 | STRW 095 120 21 XXX |
| 140                | 06                  | 06        | 604                                       | 786            | 873            | 1716           | 23          | 0.8                 | STRW 095 140 06 XXX |
|                    |                     | 11        | 799                                       | 1068           | 1198           | 2514           | 27          | 1.6                 | STRW 095 140 11 XXX |
|                    |                     | 16        | 1146                                      | 1547           | 1742           | 3748           | 33          | 2.4                 | STRW 095 140 16 XXX |
|                    |                     | 21        | 1626                                      | 2211           | 2499           | 5488           | 38          | 3.2                 | STRW 095 140 21 XXX |

Émission EN442 à 20°C

remplir code de couleur

# STRADA

# PIÈCES DÉTACHÉES

## HABILLAGE



### LIVRAISON STANDARD:

- grille
- panneau frontal
- 2 côtés
- Barre arrière
- plaques de recouvrement
- couleur 133, 001 ou 145

### CODE DE COMMANDE

CSTW 020 050 06 XXX

└─── Couleur  
└─── Type  
└─── Longueur  
└─── Hauteur

## KIT DE CHAUFFAGE



### LIVRAISON STANDARD:

- échangeur de chaleur
- supports muraux
- purgeur coudé 1/8" (Hauteur 020) ou Purgeur rallongé 1/8"
- kit de fixation
- bouchon purgeur 1/2"

### CODE DE COMMANDE

HSTW 020 050 06

└─── Type  
└─── Longueur  
└─── Hauteur

## GRILLE



### LIVRAISON STANDARD:

- couleur 133, 001 ou 145

### CODE DE COMMANDE

5621 000 050 06 XXX

└─── Couleur  
└─── Type  
└─── Longueur

## BARRE ARRIÈRE

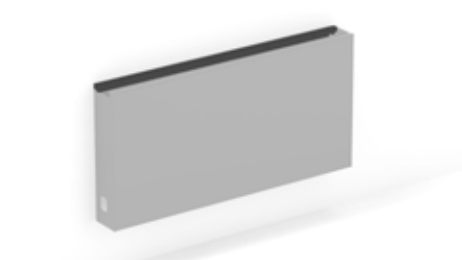

### LIVRAISON STANDARD:

- couleur 133, 001 ou 145

### CODE DE COMMANDE

5521 000 050 00 XXX

└─── Couleur  
└─── Longueur

## PANNEAU FRONTAL

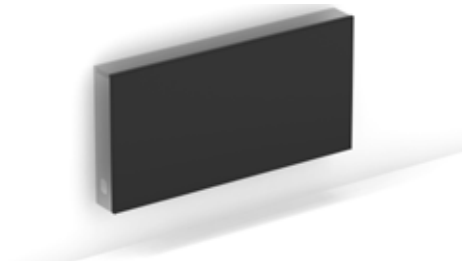

### LIVRAISON STANDARD:

- couleur 133, 001 ou 145

### CODE DE COMMANDE

5503 020 050 00 XXX

└─── Couleur  
└─── Longueur  
└─── Hauteur

## CÔTÉS (par paires)



### LIVRAISON STANDARD:

- couleur 133, 001 ou 145

### CODE DE COMMANDE

5271 020 000 06 XXX

└─── Couleur  
└─── Type  
└─── Hauteur

# STRADA

# PIÈCES DÉTACHÉES

PLAQUE DE RECOUVREMENT (argent)



CODE DE COMMANDE

22165 000 400 11

PLAQUE DE RECOUVREMENT (blanc)



CODE DE COMMANDE

22165 000 400 12

KIT DE FIXATION POUR BARRE ARRIÈRE (par paires)



CODE DE COMMANDE

5521 011

CONSOLES (par pièce)



nombre de supports pour échangeur de chaleur

- de 050 à 110 cm de long : 2 pièces
- de 120 à 220 cm de long : 3 pièces
- de 240 à 280 cm de long : 4 pièces

CODE DE COMMANDE

5121 020 000 06

Type d'échangeur de chaleur  
Hauteur

ÉCHANGEUR DE CHALEUR



LIVRAISON STANDARD:











- échangeur de chaleur
- incl. purgeur d'air perpendiculaire et bouchon purgeur

CODE DE COMMANDE

5003 000 050 06

Type d'échangeur de chaleur  
Longueur

Aperçu des types d'échangeurs de chaleur

|  | Strada Type 06   | Strada Type 10   | Strada Type 11   | Strada Type 15   | Strada Type 16  | Strada Type 20   | Strada Type 21   |
|--|--|--|--|--|---|--|--|
| <b>Hauteur 020</b>   | <br>Type 07 | <br>Type 10 |  | <br>Type 15 |   | <br>Type 20 |  |
| <b>Hauteur 035</b><br><b>Hauteur 050</b><br><b>Hauteur 065</b><br><b>Hauteur 095</b> | <br>Type 08 | <br>Type 10 | <br>Type 11 | <br>Type 15 | <br>Type 16 | <br>Type 20 | <br>Type 21 |

PURGEUR RALLONGÉ 1/8"



| CODE DE COMMANDE | H20  |    |    |    | H35 |    |    |    |    | H50 |    |    |    |    | H65 |    |    |    |    | H95 |    |    |    |    |    |    |    |    |    |    |    |    |
|------------------|------|----|----|----|-----|----|----|----|----|-----|----|----|----|----|-----|----|----|----|----|-----|----|----|----|----|----|----|----|----|----|----|----|----|
|                  | Type | 06 | 10 | 15 | 20  | 06 | 10 | 11 | 15 | 16  | 20 | 21 | 06 | 10 | 11  | 15 | 16 | 20 | 21 | 06  | 10 | 11 | 15 | 16 | 20 | 21 | 06 | 10 | 11 | 15 | 16 | 20 |
| 50900 114 078    | -    | ✓  | ✓  | ✓  | ✓   | -  | ✓  | -  | ✓  | -   | ✓  | -  | -  | -  | -   | -  | -  | -  | -  | -   | -  | -  | -  | -  | -  | -  | -  | -  | -  | -  | -  | -  |
| 50900 114 178    | -    | -  | -  | -  | -   | ✓  | -  | ✓  | -  | ✓   | -  | -  | -  | -  | -   | -  | -  | -  | -  | -   | -  | -  | -  | -  | -  | -  | -  | -  | -  | -  | -  |    |
| 50900 114 278    | -    | -  | -  | -  | -   | -  | -  | -  | -  | -   | -  | ✓  | -  | ✓  | -   | ✓  | -  | ✓  | -  | ✓   | -  | ✓  | -  | ✓  | -  | ✓  | -  | ✓  | -  | ✓  | -  |    |
| 50900 114 378    | -    | -  | -  | -  | -   | -  | -  | -  | -  | -   | -  | ✓  | -  | ✓  | -   | ✓  | -  | ✓  | -  | ✓   | -  | ✓  | -  | ✓  | -  | ✓  | -  | ✓  | -  | ✓  | -  |    |
| 50900 114 528    | -    | -  | -  | -  | -   | -  | -  | -  | -  | -   | -  | -  | ✓  | -  | ✓   | -  | ✓  | -  | ✓  | -   | ✓  | -  | ✓  | -  | ✓  | -  | ✓  | -  | ✓  | -  |    |    |
| 50900 114 728    | -    | -  | -  | -  | -   | -  | -  | -  | -  | -   | -  | -  | -  | -  | -   | -  | -  | -  | -  | ✓   | ✓  | ✓  | ✓  | ✓  | ✓  | ✓  | ✓  | ✓  | ✓  | ✓  |    |    |

Les puissances données à  $\Delta T$  50 sont des valeurs exactes calculées selon EN442. Pour tous les autres  $\Delta T$ , ce tableau donne une valeur calculée en utilisant un facteur de correction moyen valable pour toutes les dimensions.

Sur [www.jaga.com/selection-tools/](http://www.jaga.com/selection-tools/), vous pouvez télécharger des outils de calcul avec les rendements exacts. Les outils de calcul en ligne sont toujours actualisés avec les données les plus récentes. Des différences mineures de rendement entre les tableaux déjà imprimés et les différents outils de calcul en ligne sont donc tout à fait normales et s'inscrivent dans les marges de tolérance fixées par la norme.

#### FACTEURS DE CORRECTION MOYENS POUR LES PRODUITS STATIQUES SELON EN442 - 75/65/20°C

température ambiante: 20°C

Valeur N moyenne : 1.36

| TA | TR | 65   | 60   | 55   | 50   | 45   | 40   | 35   | 30   | 25   |
|----|----|------|------|------|------|------|------|------|------|------|
| 75 |    | 1.00 | 0.93 | 0.85 | 0.77 | 0.69 | 0.61 | 0.52 | 0.42 | 0.31 |
| 70 |    | 0.94 | 0.87 | 0.79 | 0.72 | 0.64 | 0.56 | 0.48 | 0.39 | 0.28 |
| 65 |    |      | 0.80 | 0.74 | 0.67 | 0.60 | 0.52 | 0.44 | 0.35 | 0.25 |
| 60 |    |      |      | 0.68 | 0.61 | 0.55 | 0.48 | 0.40 | 0.32 | 0.23 |
| 55 |    |      |      |      | 0.56 | 0.50 | 0.43 | 0.36 | 0.29 | 0.20 |
| 50 |    |      |      |      |      | 0.44 | 0.38 | 0.32 | 0.25 | 0.18 |
| 45 |    |      |      |      |      |      | 0.34 | 0.28 | 0.22 | 0.15 |
| 40 |    |      |      |      |      |      |      | 0.24 | 0.19 | 0.13 |
| 35 |    |      |      |      |      |      |      |      | 0.15 | 0.10 |
| 30 |    |      |      |      |      |      |      |      |      | 0.07 |

température ambiante: 24°C

Valeur N moyenne : 1.36

| TA | TR | 65   | 60   | 55   | 50   | 45   | 40   | 35   | 30   | 25   |
|----|----|------|------|------|------|------|------|------|------|------|
| 75 |    | 0.89 | 0.82 | 0.75 | 0.67 | 0.59 | 0.51 | 0.41 | 0.31 | 0.16 |
| 70 |    | 0.83 | 0.76 | 0.69 | 0.62 | 0.54 | 0.47 | 0.38 | 0.28 | 0.14 |
| 65 |    |      | 0.70 | 0.64 | 0.57 | 0.50 | 0.43 | 0.35 | 0.25 | 0.12 |
| 60 |    |      |      | 0.58 | 0.52 | 0.45 | 0.38 | 0.31 | 0.23 | 0.11 |
| 55 |    |      |      |      | 0.47 | 0.41 | 0.34 | 0.28 | 0.20 | 0.09 |
| 50 |    |      |      |      |      | 0.36 | 0.30 | 0.24 | 0.17 | 0.08 |
| 45 |    |      |      |      |      |      | 0.26 | 0.20 | 0.14 | 0.06 |
| 40 |    |      |      |      |      |      |      | 0.17 | 0.12 | 0.05 |
| 35 |    |      |      |      |      |      |      |      | 0.09 | 0.03 |
| 30 |    |      |      |      |      |      |      |      |      | 0.02 |

Facteurs de correction moyens pour Strada (sans DBH). Facteurs de correction exacts pour Strada ou Strada Hybrid : voir les outils de sélection

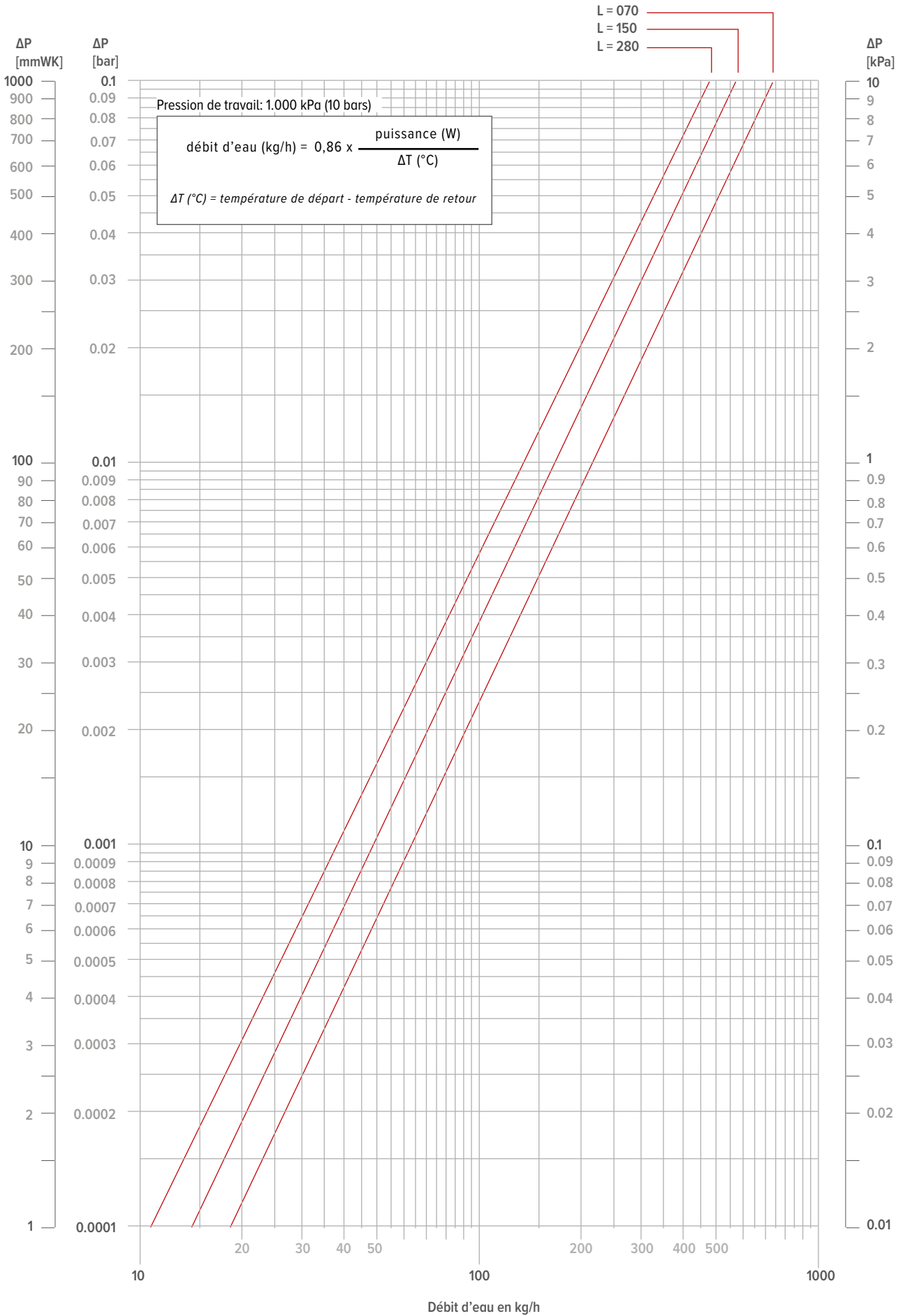

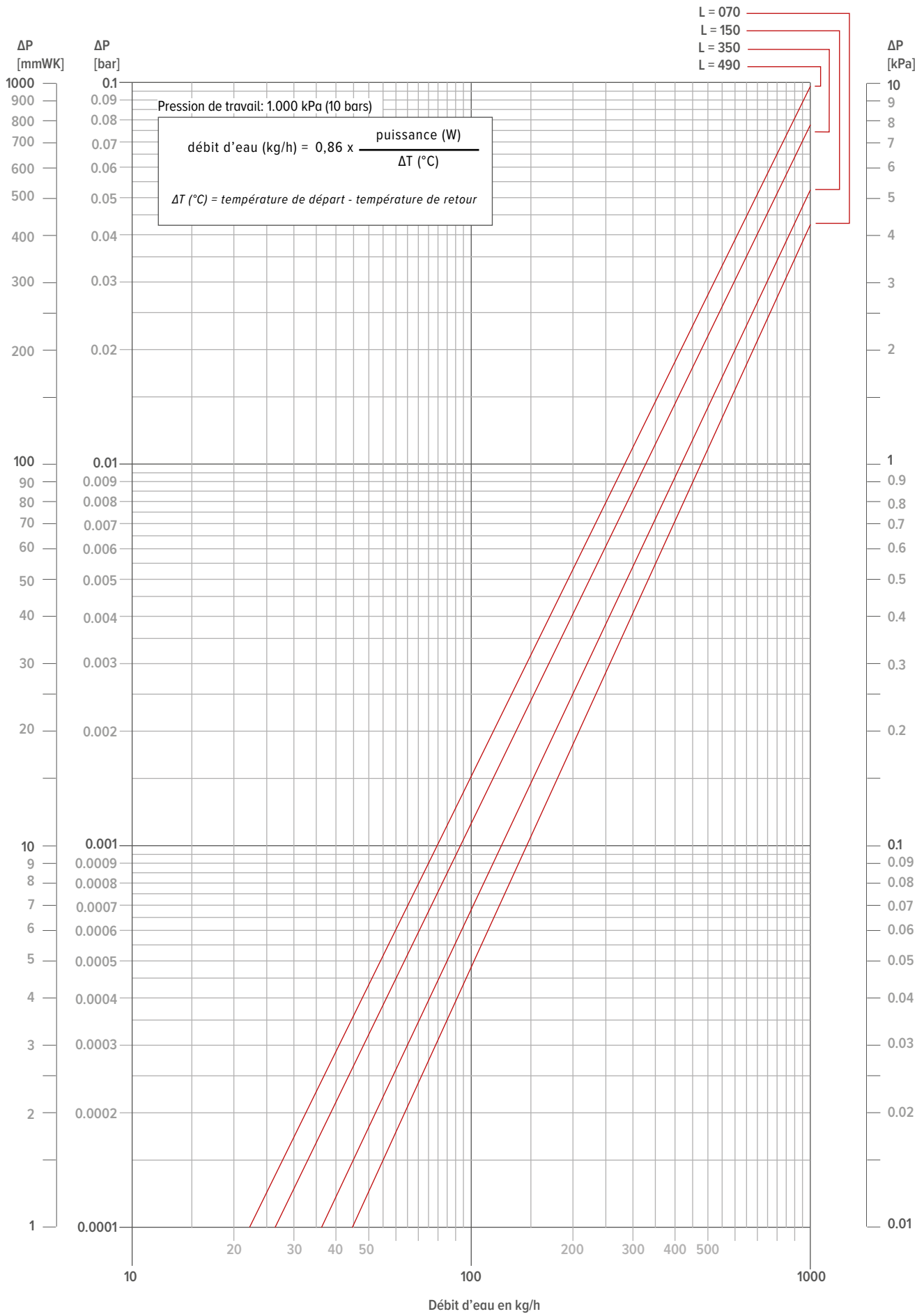

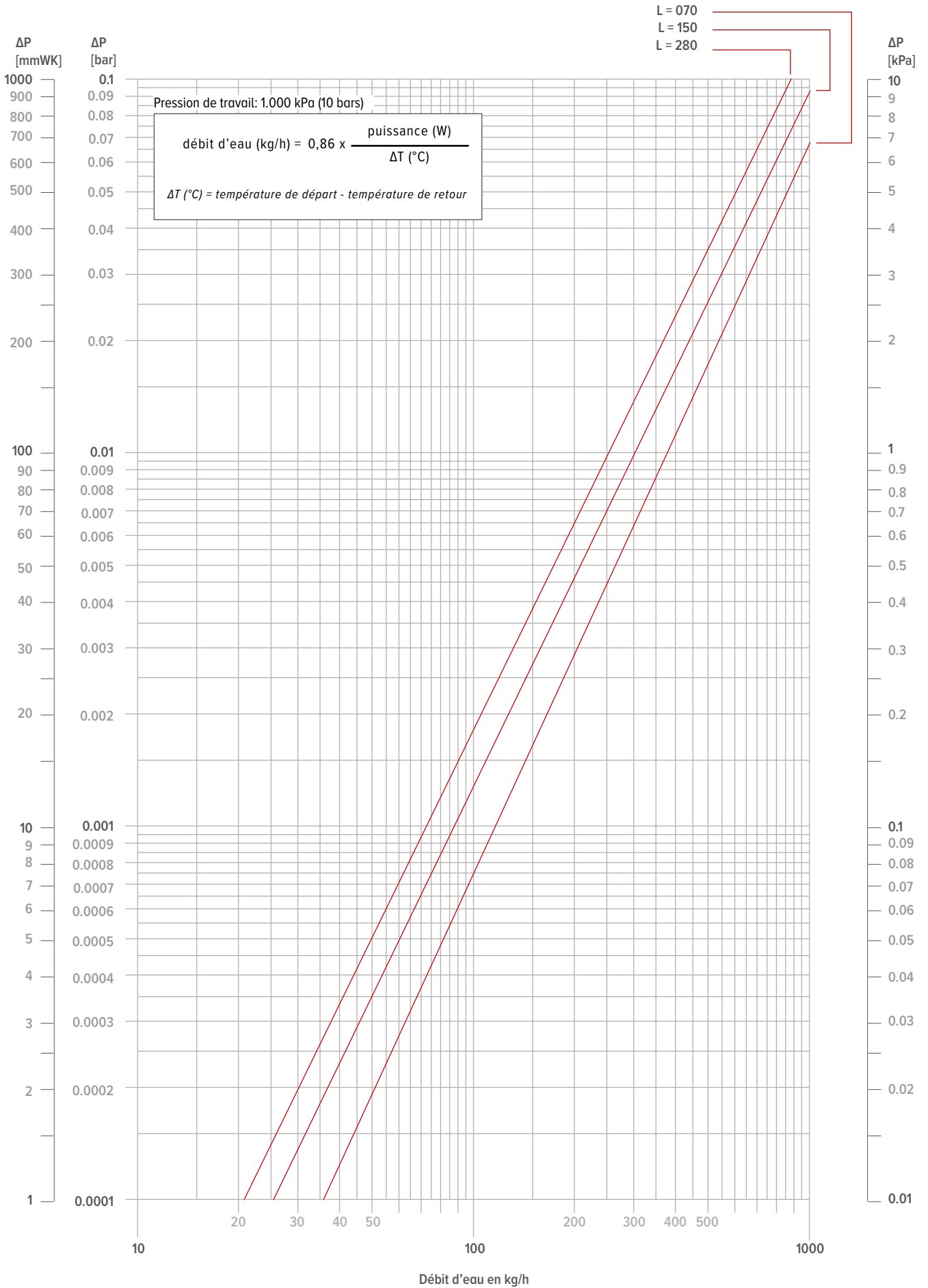

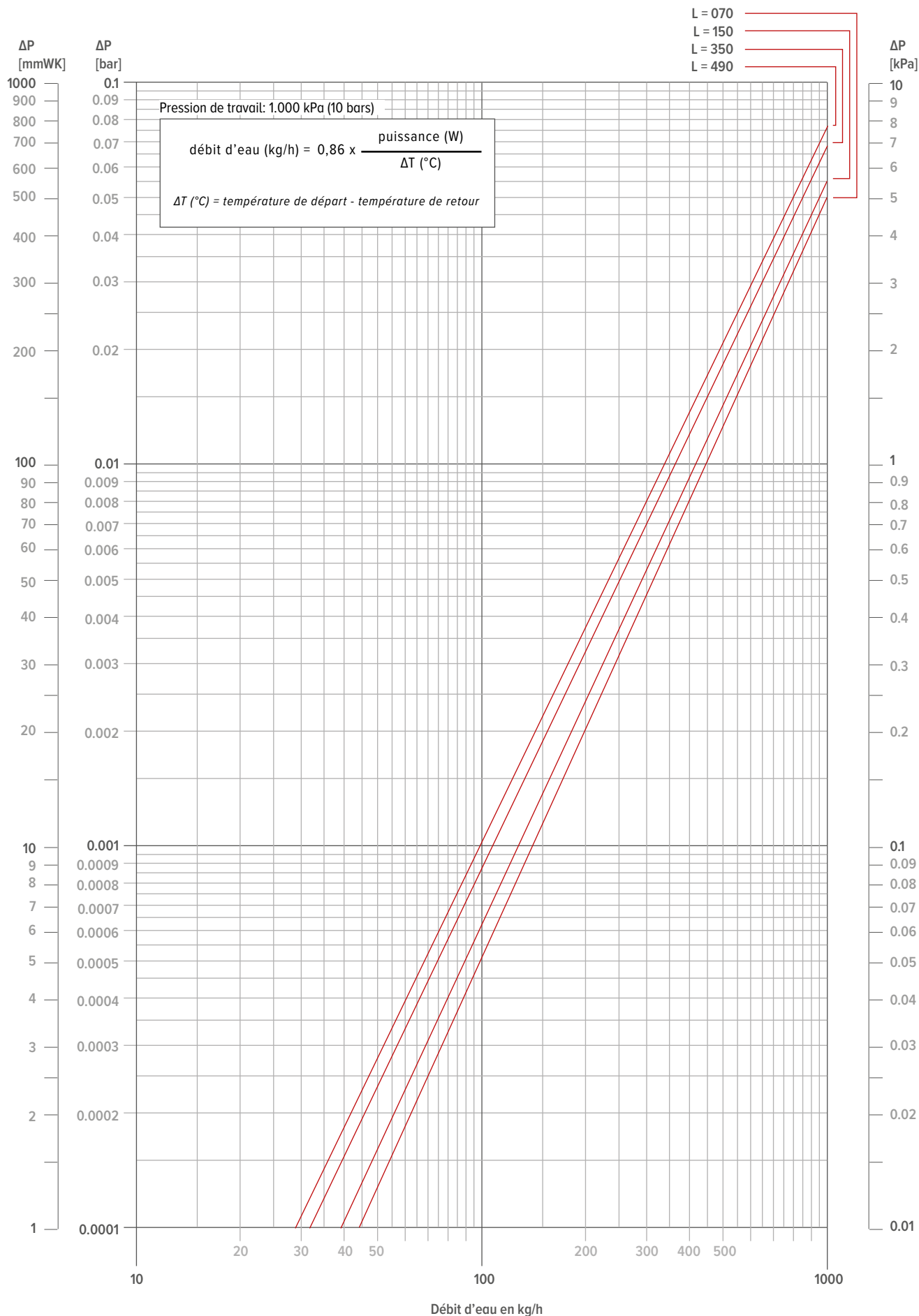



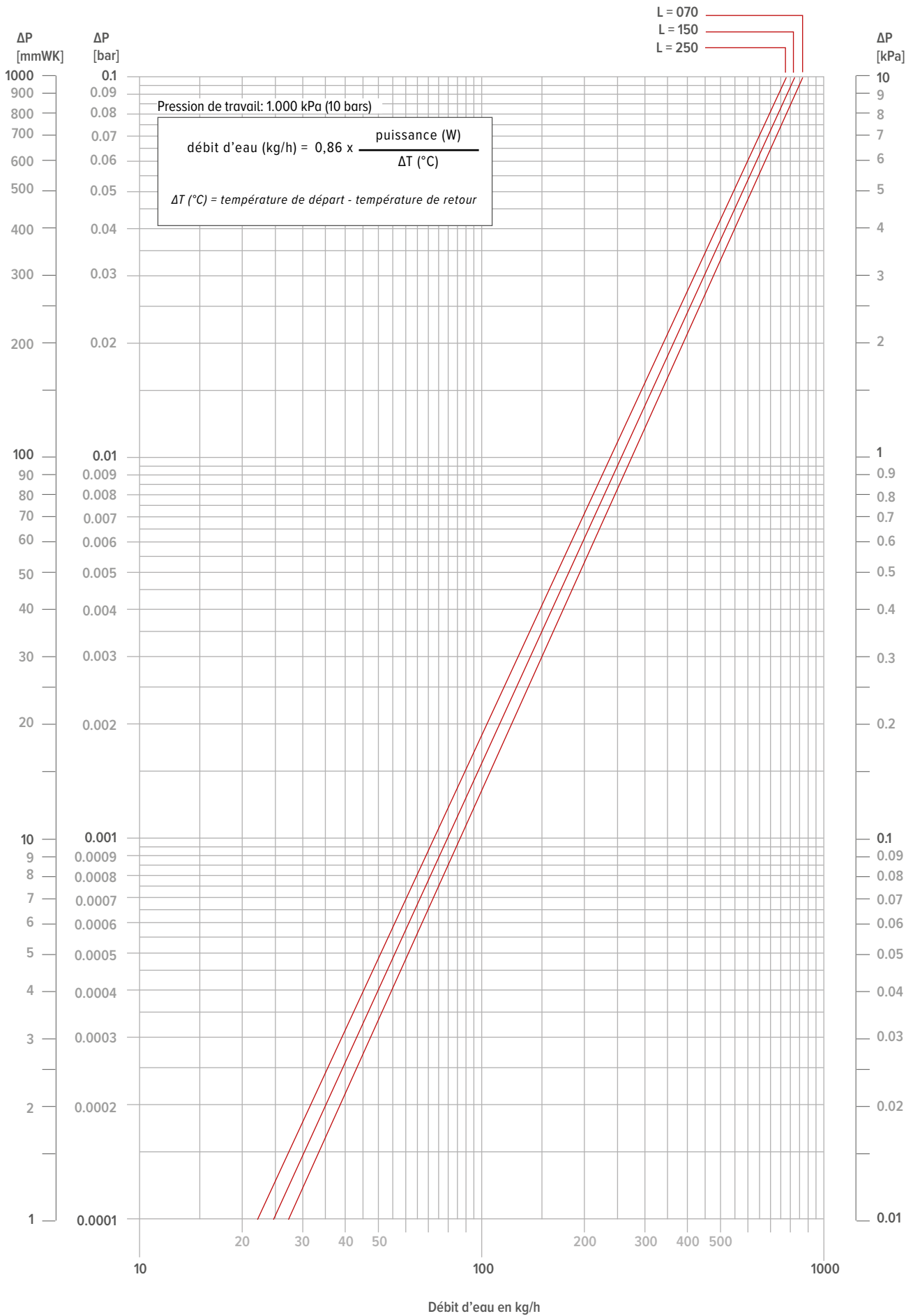

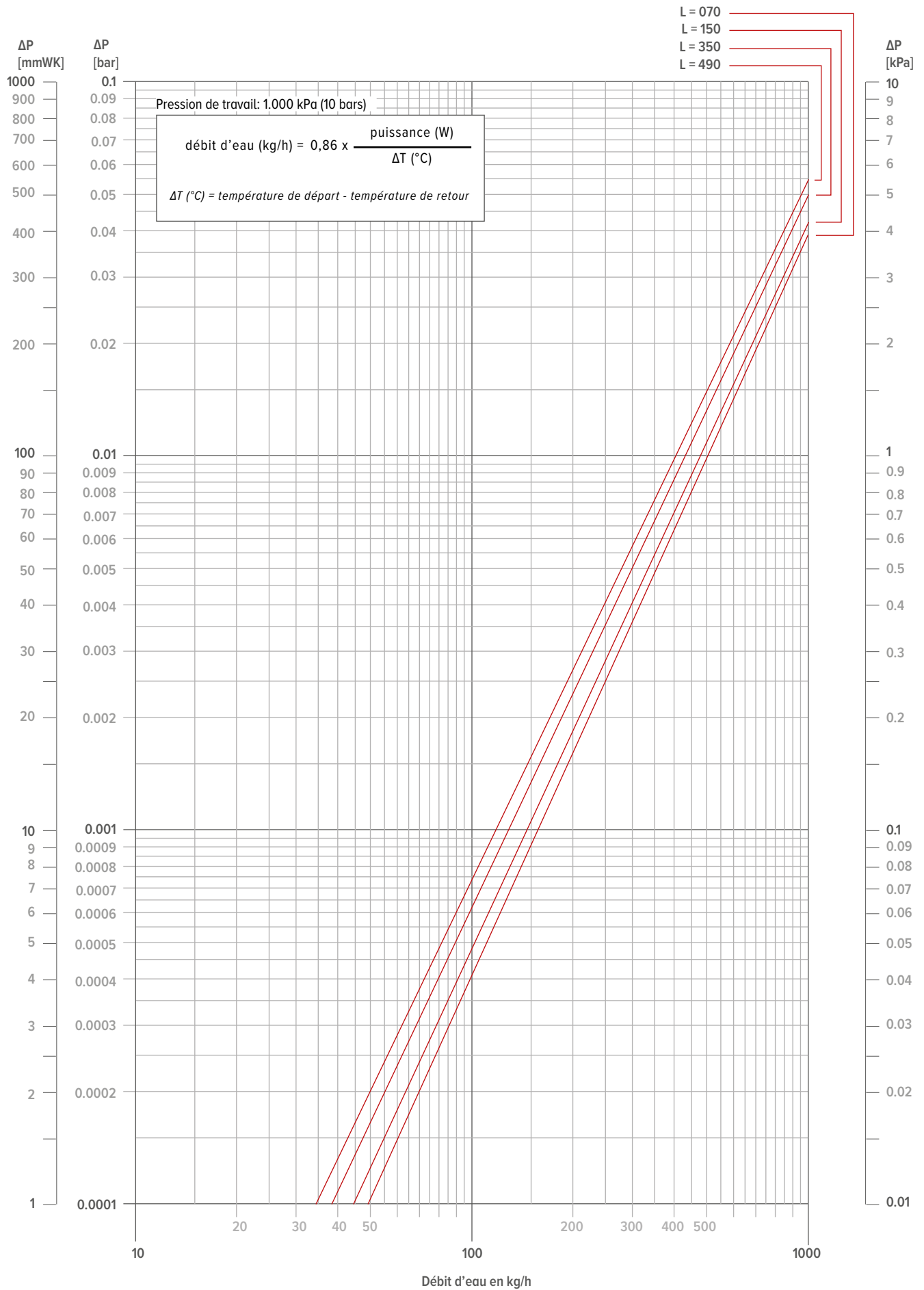

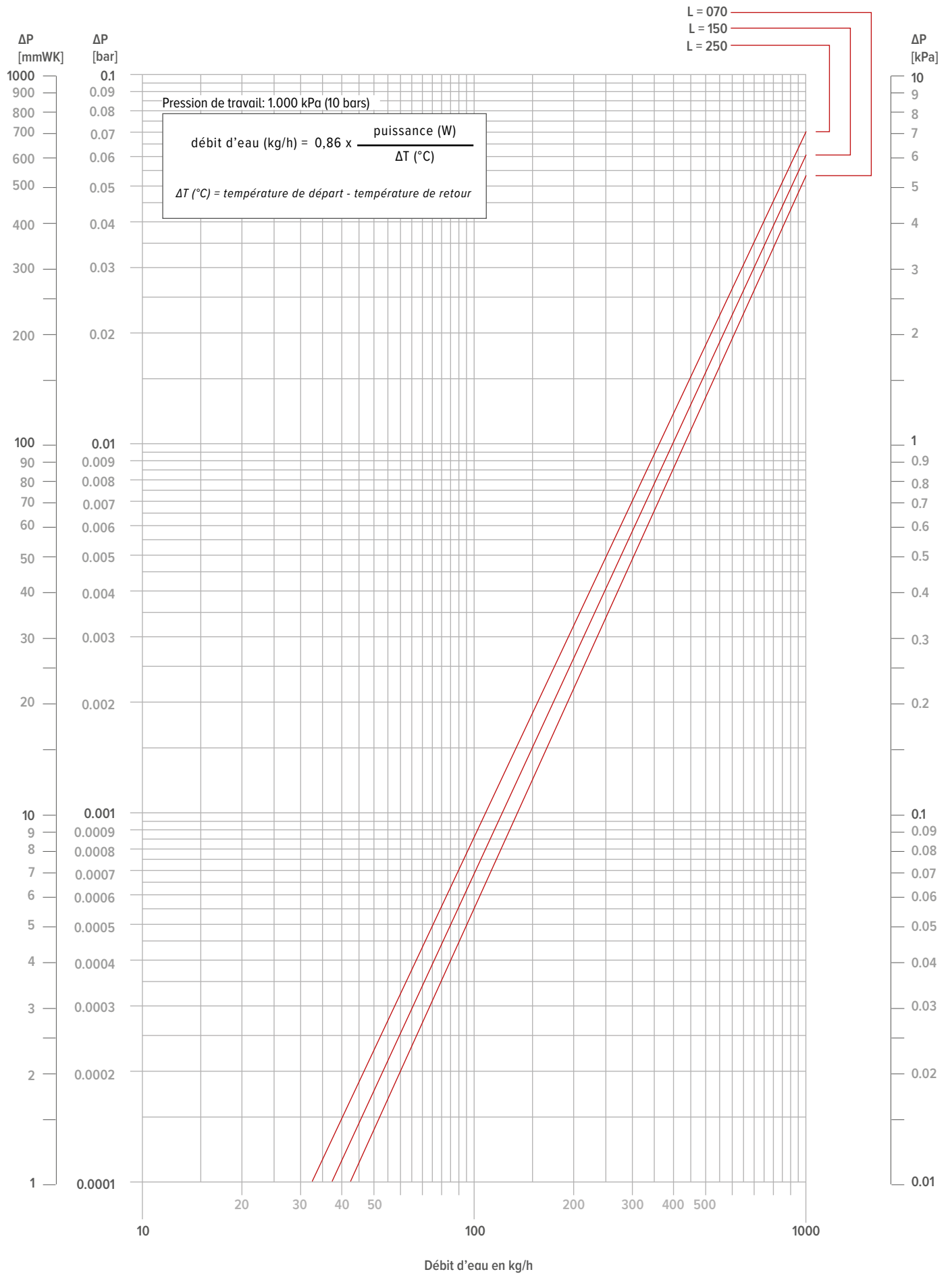



**jaga** CLIMATE  
DESIGNERS

**BELGIQUE JAGA SA**

Besoin d'un conseil ? Prenez rendez-vous au Centre de Conseils Jaga !

Verbindingslaan 16  
3590 Diepenbeek

+32 (0) 11 29 41 11

info@jaga.be  
jaga.com